

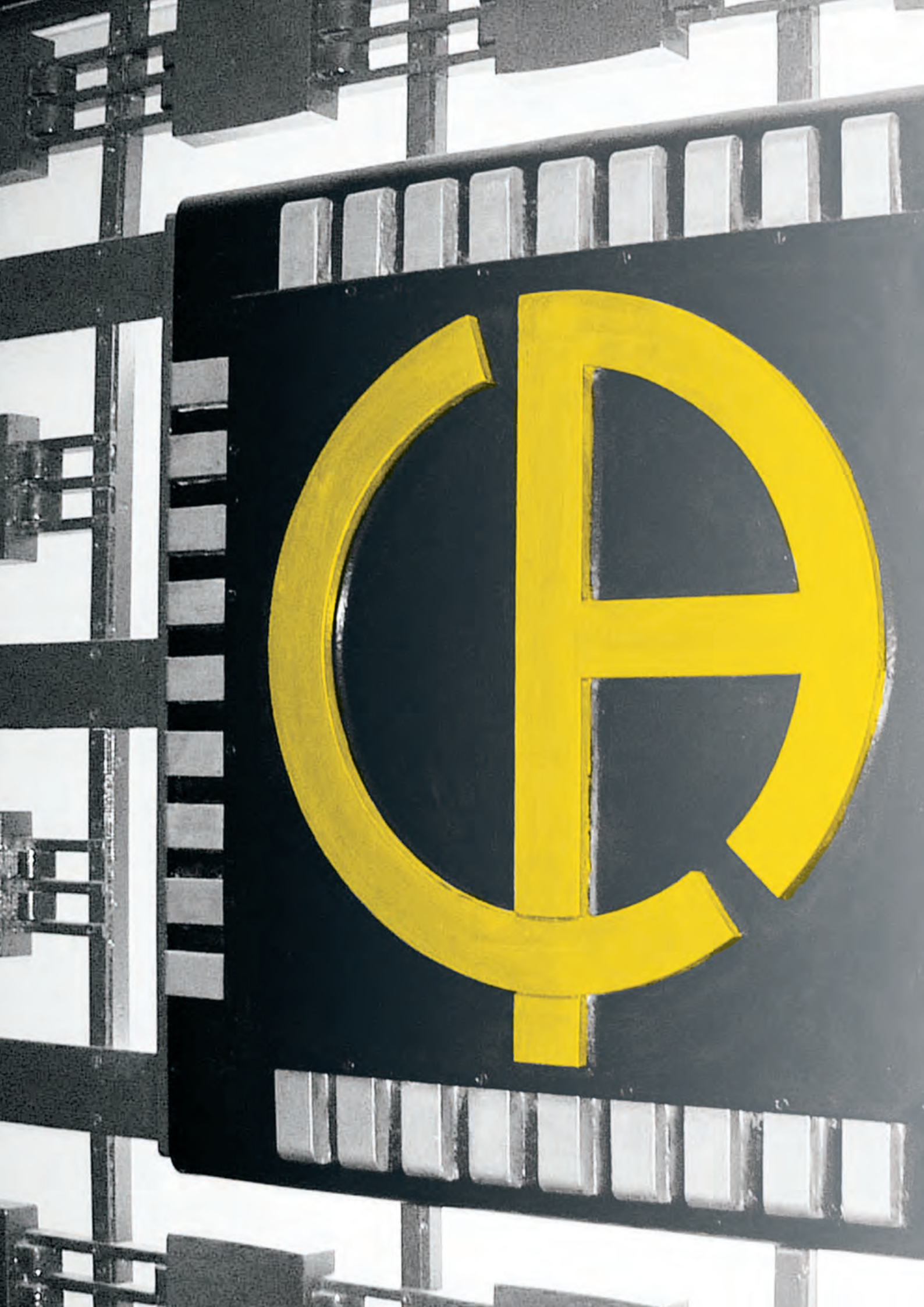

TEST & MEASUREMENT 2022





THE CHAUVIN ARNOUX GROUP

About the Chauvin Arnoux Group 4

UNIVERSAL TEST AND MEASUREMENT 14

Testers	16
Voltage detectors	18
Analogue multimeters	21
Digital multimeters	23
Digital ammeters	28
Digital clamps	29

ELECTRICAL SAFETY 34

Installation testers	39
Insulation testers	45
Multimeter clamps for leakage current	55
Earth and resistivity testers	56
Electrical equipment testers	63
Other testers	68
Data processing software	74
Accessories	76

ENERGY QUALITY & INSTALLATION MONITORING 84

Power and harmonics clamps	86
Power and energy quality analysers	88

SOLAR POWER ANALYSERS 93

Loggers	94
Data processing software	102

PHYSICAL & ENVIRONMENTAL MEASUREMENTS 106

Calibrators	108
Thermal cameras	111
Thermometers	116
PH-meters	132
Conductimètre	133
Other physical and environmental measuring equipment	123

CURRENT MEASUREMENT 138

Current clamps AC	139
Current clamps AC/DC	141
Flexible sensors and probes	142

LABORATORY & EDUCATIONAL INSTRUMENTATION 144

Training benches	146
Training cases	147

ACCESSORIES 150

Cables & measurement probes with $\varnothing 4$ banana connections	150
Accessories for Voltage Absence Testers or product-specific accessories	152
Other accessories	153
Protection, storage and transport	154
Fuses	156

METRIX 158

Analogue testers & multimeters	160
On-site multimeters	164
Digital multimeters	170
Pocket clamp multimeters	174
On-site electrical safety tester	178
Benchtop oscilloscopes	181
Portable digital oscilloscopes	187
Spectrum analyser	198
Generators	200
Power supplies	206
Multifunction calibrators	208
Training cases and shunts	210
Accessories for oscilloscopes	211
Fuses	219

128 YEARS OF DEVELOPMENT

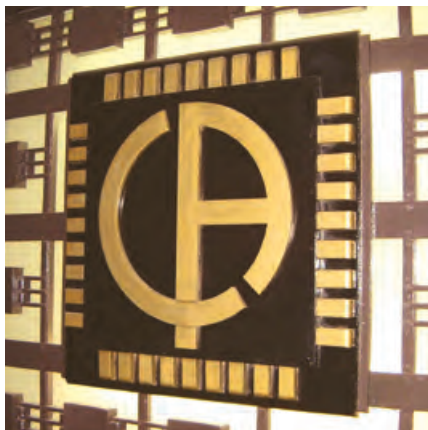

Logo on the company's former main gate

Every story starts somewhere. The story of the Chauvin Arnoux company as an inventor and manufacturer of measuring instruments since 1893 is rich in developments and innovations. Today, its products bear witness to and reflect the sociological and technological changes and the industrial innovations which marked the previous century. A fascinating story that explains why and how Chauvin Arnoux's image and personality evolved... in two colours.

It is often said that at the root of knowledge is language, or that the origin of an innovation was an idea... yet it is the individual, the person, who is really the source of knowledge and discoveries. This also applies to electricity, which was not invented in the 19th century, but discovered in the 6th century BCE by a Greek philosopher and scientist named Thales, the first person to note the electrostatic properties of amber.

From the beginning of the 19th century, there was the yellow of amber. Then manufactured goods began to include the yellow of brass and copper, materials used in measurement instruments, either for the casings of galvanometers or for the connections of electrical measurement instruments. Beige was also introduced with the use of varnished wood in the casings, while black was reserved for the instruments' dials. Right from the start in 1893, the contrast between black and the yellow of varnished wood soon became the norm for the measurement instruments produced by Chauvin Arnoux.

In a relatively short time, between 1900 and 1936, with the development of new technologies and new techniques for working materials, yellow brass began to be used with black Bakelite, eventually spreading to nearly all our instruments.

Already known for its sense of design and the combination of its original colours yellow brass and black, in its measurement instruments, Chauvin Arnoux reproduced these colours in its first corporate logo in 1927.

In the 1940s, many measurement instruments only used black or black and the silver-grey of ferrous metals, sometimes painted. Chauvin Arnoux adapted its original visual identity to suit the fashions of the time, which also corresponded to technical criteria for safety, life-span extension or weight considerations linked to the metal and the manufacturing process used.

The 1950s saw the arrival of rubber-like materials, used for the bases of portable instruments, and subsequently for the shockproof sheaths made of black

neoprene, first designed and patented by Metrix® and Chauvin Arnoux in 1958. These shockproof sheaths later became widely used on the handheld instrument market.

With the 1970s came plastics technology. This was when Chauvin Arnoux launched worldwide its first innovative products made of black and yellow plastic: the CDA 8 tester in 1979, the CDA 600 multimeter clamp in 1982, followed by the whole range. Some earth testers, such as the Terca in 1985 and the Prowatt wattmeters in 1989, also had a yellow casing..

The combination of yellow and black for on-site equipment began to spread with its use for safety signage and for identifying hazardous areas on site. This encouraged Chauvin Arnoux to launch the well-known IMEG 500 or ISOL1000 series in Europe and then in the United States with the company's two colours.

The MAN'X 500 series launched by Chauvin Arnoux, the very first multimeters made of a flexible material, further strengthened the company's visual identity. At about the same time, Metrix launched several products with yellow casings and black platens, including the instruments in its MX 44 series (1988) followed by the MX 51 series.

Over the years, Chauvin Arnoux has developed its visual identity across all its product ranges: its multimeters, wattmeters, megohmmeters and installation testers all bear the company's colours.

One last remark about colours: while yellow is always seen as the colour of the sun and of certain kings or emperors in Asia, it is not so widely known that in physics, black is the symbol of a "black body", meaning a system which absorbs all the light it receives. Black and yellow? A historic tandem for Chauvin Arnoux which was the first company to use this pairing for its corporate visual identity in the early 20th century when it first designed its logo in 1927.

Axel Arnoux



1895 reflection galvanometer

This calibration potentiometer dating from 1900 was used with a standard battery and a galvanometer like the one shown above. Its price was 195 francs!

The Monoc L

CDA 600 Polyclamp (1982)

On both the French MICA multimeter in 1985 and the ANAGRAF American version available the same year, the yellow of Chauvin Arnoux is clearly in evidence.

MX 51

PRINT & DIGITAL MEDIA FOR COMPLEMENTARY COMMUNICATION WHILE KEEPING IN CONTACT



Whatever the device used, whether it is a smartphone, tablet or computer, Chauvin Arnoux offers users a website which guides them as they browse. It is simple to find, share and combine information, and offering more relevant information is an obvious target which the Group strives to achieve every day.

A STRUCTURED WEBSITE

Whatever the device used, whether it is a smartphone, tablet or computer, Chauvin Arnoux offers users a website which guides them as they browse. It is simple to find, share and combine information, and offering more relevant information is an obvious target which the Group strives to achieve

every day. Chauvin Arnoux, Chauvin Arnoux Energy, Pyrocontrol, Indatech and Manumasure: each of these entities presents the full extent of its offering through its products, its skills, its applications and its publications, backed by a common visual identity giving a structured image of the Group.

ONLINE SALES

The Group proposes online sales of its main products. With just a few clicks, you can order the products and accessories you need, which then be delivered directly to you or to a pick-up location.

CHAUVIN ARNOUX METROLOGY & REGULATORY ENVIRONMENTAL TESTING

Electrical, climatic, dimensional, force, weighing... Let us calibrate your measuring instruments!

- 12 agencies all over France
- Operations on site and in the laboratory
- Maintenance, fleet management, repair, etc.

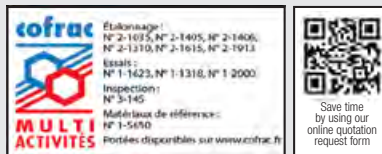

CONTACT US info@manumasure.fr Tel.: + 33 231 64 51 35 www.manumasure.fr

PRESENT ON SOCIAL MEDIA

Follow all Chauvin Arnoux's news on the three main social media and our YouTube channel.

- Facebook**
www.facebook.com/ChauvinArnouxFrance
- Twitter**
twitter.com/ChauvinArnouxFr
- LinkedIn**
www.linkedin.com/company/99353
- Youtube**
www.youtube.com/c/chauvinarnouxgroup

CHAUVIN ARNOUX, A LONG-TERM PARTNER FOR EDUCATION

Drawing on its long history of close, privileged links with the French National Education system, the Chauvin Arnoux Group supports the players in education by participating in a large number of events, publishing the review "Les Cahiers de l'Instrumentation" and offering measuring instrumentation suited to the teaching requirements. A Measurement Certification and a dedicated website for students and teachers are also proposed to deal with the new constraints and to accompany tomorrow's professionals as closely as possible.

THE "MEASUREMENT CLUB": A GENUINE FORUM FOR EXPERTISE!

The "Club du Mesurage" (Measurement Club) is a genuine think-tank bringing together experts from business and education in order to generate a constant flow of information about the evolution of the standards, the new market requirements, applications and particularly new applications... Open



to all members of the Education sector, this Club allows genuine theoretical debate as well as creating a forum of expertise between two communities brought together by common objectives, leading every year to publication of Chauvin Arnoux's magazine for Education, "Les Cahiers de l'Instrumentation".

"LES CAHIERS DE L'INSTRUMENTATION": THE MAGAZINE FOR EDUCATION

The magazine "Les Cahiers de l'instrumentation" is a collection of practical exercises published annually for teachers and their students, providing concrete illustrations of solutions or the use of measuring, testing and energy control instruments.

A PRODUCT OFFERING DEDICATED TO THE EDUCATION SECTOR

The Chauvin Arnoux Group proposes a special dedicated offering for the world of education which is presented every year in the "Selection for Education" catalogue.

PARTNER OF MANY EDUCATIONAL EVENTS

Every year, the Chauvin Arnoux Group acts as a partner

and sponsor for a large number of events linked to the educational sector, intended to promote technical and scientific education by measuring equipment loans, the participation of Chauvin Arnoux managers in the judging panels or the provision of prizes for competitions.

MEASUREMENT CERTIFICATION DEDICATED TO STUDENTS AND TEACHERS

To deal with the new constraints and to support tomorrow's professionals as closely as possible, CHAUVIN ARNOUX has set up a measurement certification programme, in cooperation with the French national education system. The aim of this certification is to confirm students' knowledge of the use of measuring instruments by means of an online multiple-choice questionnaire.



Discover Measurement Certification:
certification-mesure.chauvin-arnoux.com

CHAUVIN ARNOUX, A CERTIFIED TRAINING ORGANIZATION SINCE 1993

The Chauvin Arnoux Group proposes six one-day training modules. Whether you need theoretical training or practical experience based around a product, choose the market leader to train you and your staff. A training course dedicated to energy auditing has been set up specially to help you perform the right measurements.



ENERGY AUDITS: CHOOSE THE RIGHT MEASUREMENTS

- The advantages of energy auditing
- Economical, environmental and regulatory constraints
- People authorized to perform an energy audit
- Towards a continuous improvement process: the ISO 50001 standard
- Choosing the right measuring tool
- Defining the potential sources of energy savings and the related measurements
- Implementing appropriate solutions



UNDERSTANDING AND OVERCOMING HARMONICS

- The basics of harmonic phenomena.
- Identifying and characterizing the sources of disturbances.
- Measuring and detecting the phenomena in experimental conditions using a harmonic analyser.
- The applicable standards and labels.
- Understanding the effect of harmonics on the electrical components using real cases.
- How to deal with harmonic disturbances.



THERMOGRAPHY

- Understanding heat exchange phenomena.
- Measuring with an infrared thermographic camera.
- Interpreting the measurements.
- Overview of all the applications of thermography and the present obligations.



ELECTRICAL INSTALLATIONS AND ENERGY QUALITY

- Excessive consumption of reactive energy leading to penalty payments.
- Loss of service continuity at the first fault on an IT system.
- Untimely tripping of the circuit-breakers protecting industrial electrical equipment.
- Untimely tripping of RCDs.
- Random fault on an electricity distribution system.

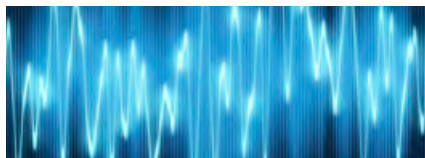

ELECTRICAL INSTALLATIONS AND IEC 60364-6

- Properties and objectives of the earth/ground connection systems
- Behaviour of the earth/ground connection systems with regard to harmonics
- Insulation resistance measurement
- Electrical continuity measurements on protective conductors
- Resistance measurements on earth/ground electrodes
- Residual Current Device (RCD) testing



CA 8336 NETWORK ANALYSER

- Setup and connections
- Presentation of the various measurements and functions: waveforms, harmonics, transients, alarms, etc.
- Recording and measurement campaigns
- Analysis of the measurement results
- Simulation exercise with the instrument on an electrical model

Training courses provided at the Chauvin Arnoux Group's new headquarters in Asnières, at the gates of Paris.

- Expert training instructors acknowledged in their fields
- Innovative demonstration equipment to understand and operate
- Limited number of participants for high-quality discussions



TRAINING IS AN ESSENTIAL ADVANTAGE IN ANYONE'S CAREER.

- Favouring skills development
- Gaining access to the different levels of qualification
- Obtaining authorizations

Detailed training schedule and registration form available from www.chauvin-arnoux.com or by sending a simple request to formation@chauvin-arnoux.com



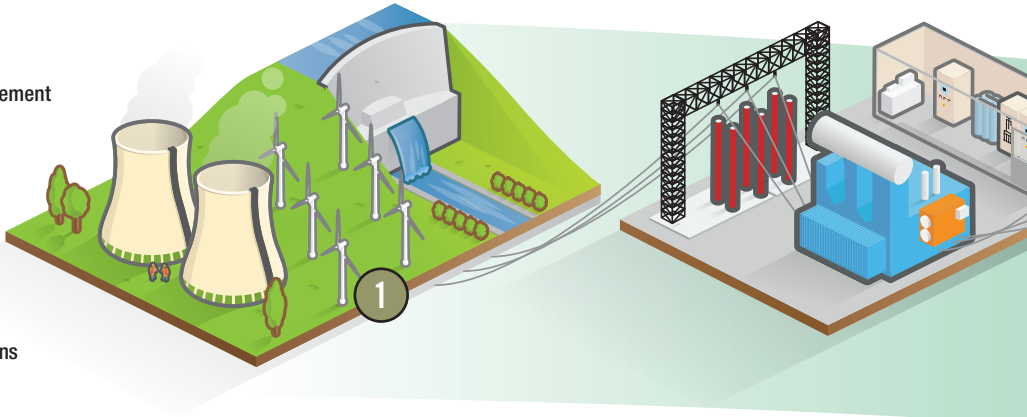

APPLICATIONS: GENERATION, TRANSMISSION & DISTRIBUTION

EARTH/GROUND CONNECTION TESTING

- 1  Soil resistivity and earth/ground measurement
CA 6470N
- 2  Measurements on pylons
CA 6474
- 3  On MV/HV lines
CA 6472



INSTALLATION MAINTENANCE AND TESTING

- 4  Separation of installations, voltage absence testing, phase sequence testing
CA 773
- 5  Testing of circuit-breakers and equipotential bonds
CA 6240 - CA 6292
- 6  15 kV insulation testing
CA 6555
- 7  Current measurements
MA4000D

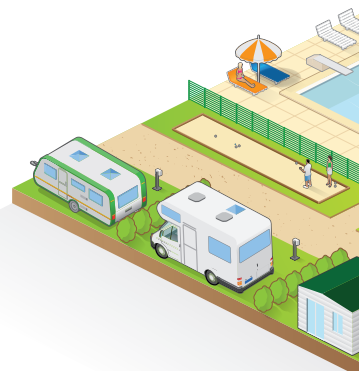
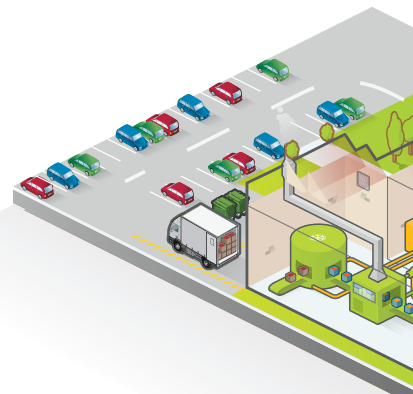

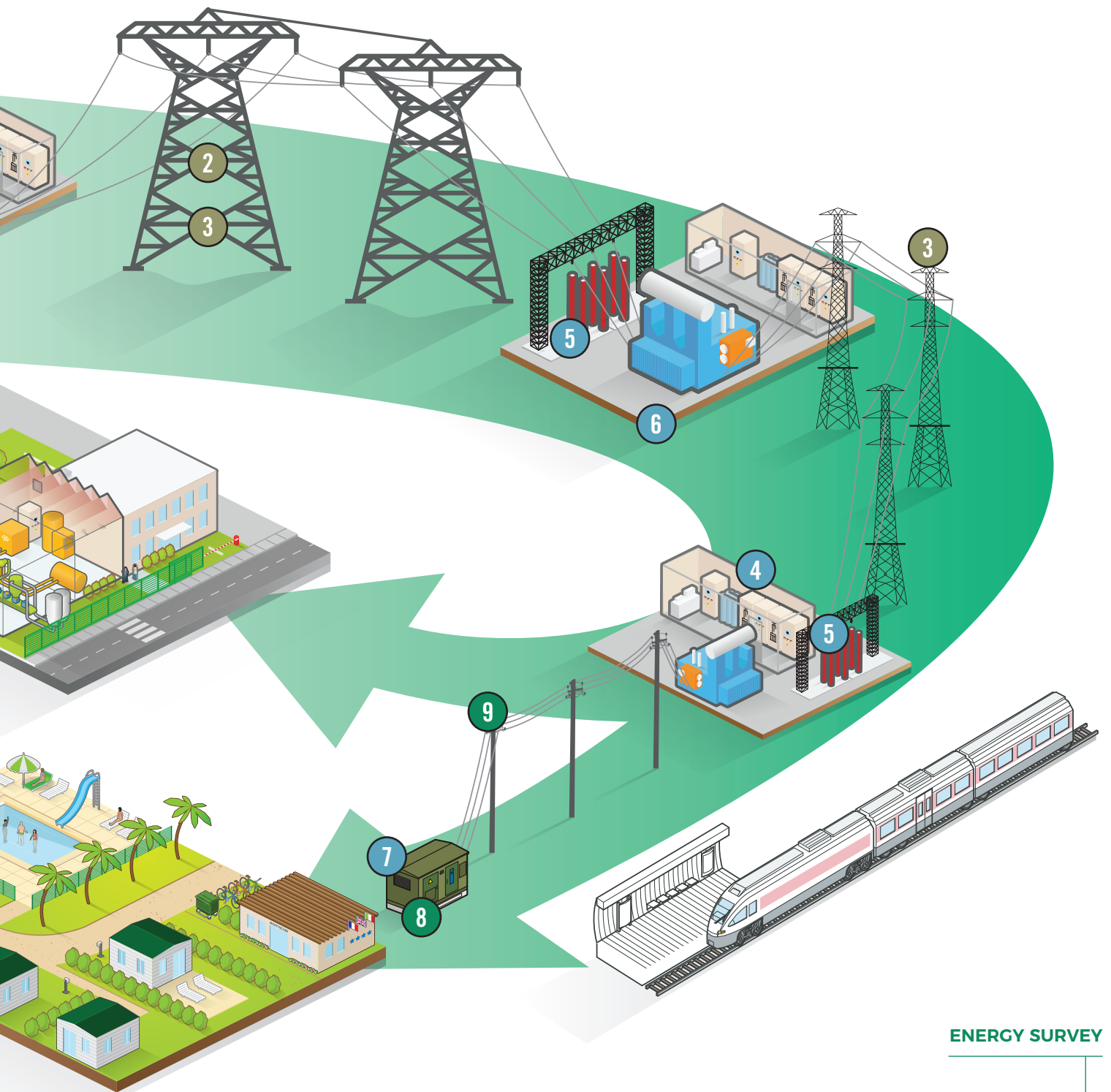

Electrical consumption monitoring

PEL106



8

Analysis of electrical network quality (flicker, over- and undercurrent/voltages/harmonics)

CA 8336



9

ENERGY SURVEY

APPLICATIONS: INDUSTRY

DETECTION OF ELECTRICAL DISTURBANCES

1  Power quality analysis
CA 8336

2  Recording of voltage drops and voltage surges
L261

INDUSTRIAL MAINTENANCE

3  Testing for electrical or mechanical overheating
CA 1954

REGULATORY TESTING OF THE WORKING ENVIRONMENT

4  Noise
CA 1310

5  Lighting
CA 1110

6  Humidity
CA 1246

7  Electric fields
CA 40

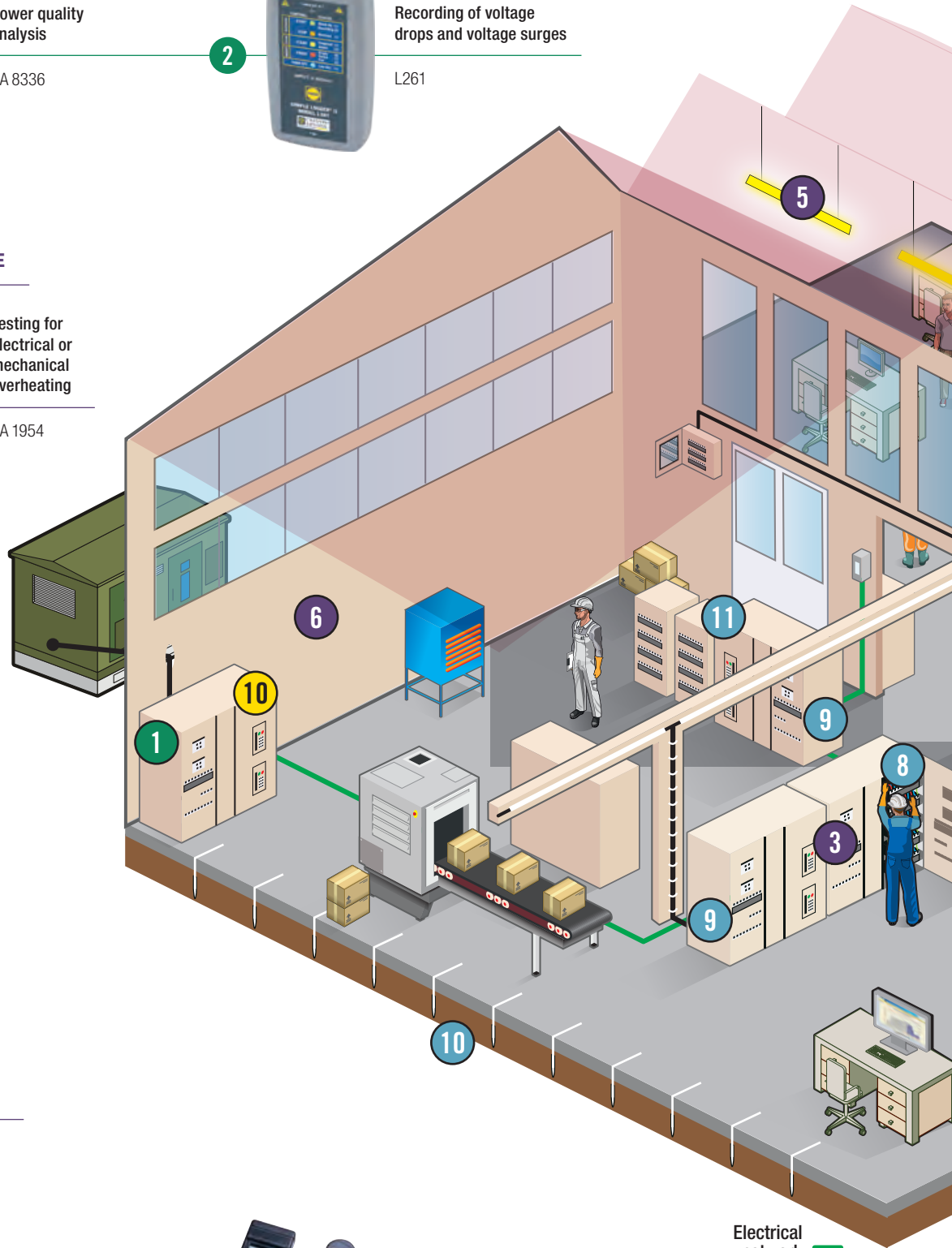

Electrical network —

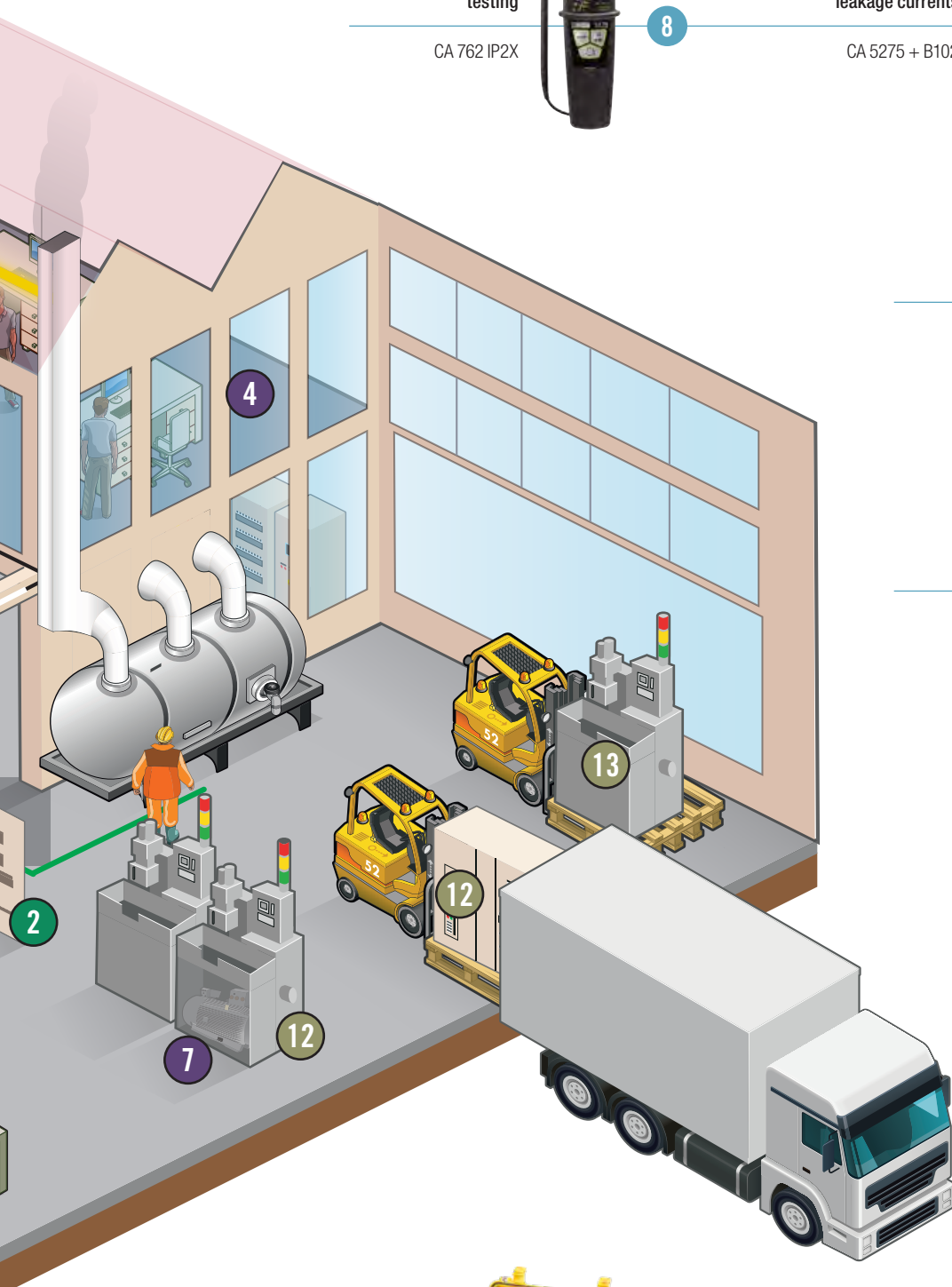

SAFETY OF PEOPLE

Voltage absence testing

CA 762 IP2X



8

Detection of leakage currents

CA 5275 + B102



9



Earth/ground testing

CA 6417



10

Insulation testing

CA 6524



11

Industrial machine testing

CA 6165



13

Electrical cabinet testing

CA 6155



12

MANUFACTURING QUALITY CONTROL

APPLICATIONS: HOUSING & TERTIARY

REGULATORY TESTING AS PER IEC 60364-6

1 Earth/continuity measurement
CA 6462



2 Comprehensive electrical safety testing on installations
CA 6116N



ENERGY EFFICIENCY

3 Measurement of insulation, leakproofing and thermal bridges
CA 1954



4 Temperature, air speed and air flow-rate measurement
CA 1227



5 CO₂ temperature and humidity testing
CA 1510



6 Recording and analysis of electrical consumption
PEL104

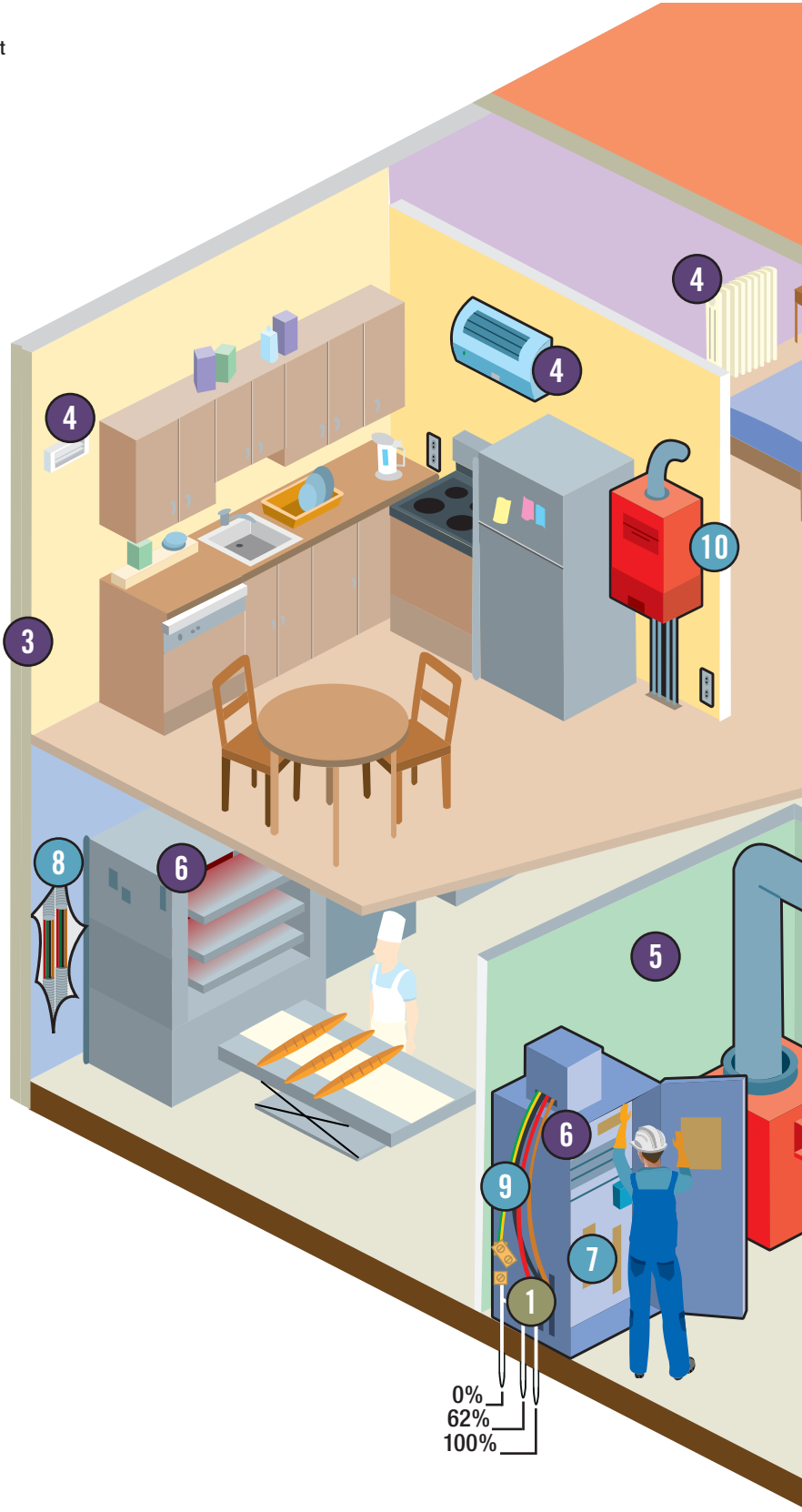

GENERAL ELECTRICAL RENOVATION WORK

Testing of the power supply and continuity of electrical connections

CA 755



7

Detection and location of cables and metal conductors

CA 6681



8

Verification of voltages, currents and electrical continuity

F201



9

Ionization current measurement on gas boilers

CA 5277



10

THE STANDARDS	14
TESTERS	16
VOLTAGE ABSENCE TESTERS	18
ANALOGUE MULTIMETERS	21

DIGITAL MULTIMETERS	23
DIGITAL AMMETERS	32
DIGITAL CLAMP METERS	29
ACCESSORIES	32

THE STANDARDS

EN 60529

The EN 60529 standard defines the level of tightness (leakproofing) of an instrument against penetration by solids or water. The IP rating corresponds to the instrument's level of protection against penetration by solids (1st digit) and by water (2nd digit). The higher the rating, the more effective the protection. A product without protection corresponds to a rating of IP00 (minimum rating), whereas a product totally protected against penetration by solids and liquids would have a rating of IP68 (maximum rating).

IEC 61010

This international standard defines the safety rules for electrical measuring, control and laboratory instruments. It helps to ensure that the design and construction of the instruments protect users and their environment against electric shocks, burns, mechanical hazards, the spread of fire from these instruments, excessive temperatures, etc.

For some types of instrument, this standard is completed by specific instructions.

The development of industrial and domestic equipment is increasing the hazards which may be encountered on an electrical installation, notably in terms of ever-higher voltage surges. On LV installations, where the voltages are limited to 1,000 V_{AC} and 1,500 V_{DC}, the hazard levels depend the type of installation and the voltage level.

Les normes internationales de la famille CEI 61010 concernent les règles de sécurité pour appareils électriques. Les normes internationales de la famille CEI 61010 concernent les règles de sécurité pour appareils électriques. Plus spécifiquement, la norme IEC 61010-031 et son amendement A1 définissent les règles de sécurité pour les instruments de mesure, de contrôle et de laboratoire et leurs accessoires. Dans la nouvelle édition qui est entrée en vigueur le 1^{er} mars 2011, cette norme a été complétée par le chapitre 13 traitant de la « prévention des dangers liés aux courts-circuits et aux arcs électriques ».

Cette addition stipule les règles de travail pour les installations CAT III et CAT IV :

- La partie conductrice des sondes de test ne doit pas dépasser 4 mm de longueur
- Les surfaces externes des mâchoires des crocodiles doivent être non conductrices et les parties conductrices ne doivent pas être accessibles lorsque la pince est fermée.

La norme IEC 61010-2-033, première publiée le 09/02/2013, a apporté des changements concernant les multimètres, les multimètres à pince, etc. Depuis le 9^{er} mars 2015, ces instruments ont dû garantir un niveau de sécurité minimum correspondant au moins à la catégorie CAT III 300 V.

SAFETY RULES AND GOOD PRACTICES

- Use measuring instruments and accessories which are suitable for the application and the measuring conditions.

Prefer CAT IV instruments:

- They can withstand voltage surges which are up to 50 % greater than a CAT III product
- CAT IV 1000 V provides protection against electric shocks up to 12,000 V, while CAT IV 600 V instruments protect up to 8,000 V.
- Using a lower-category instrument means checking that the installation is equipped with protective systems (disconnecting switch, circuit-breaker, etc.) which are functional and in good condition. This is often the case... but not always!
- For outdoor or temporary installations or for installations upstream of the protective systems, CAT IV instruments must be used.
- It is the weakest element which defines your level of protection. If you use accessories of a lower category or with a lower voltage than your measuring instrument, the global level of safety offered by your measuring system will be reduced.
- Use accessories in perfect condition. Any accessory which is faulty, however slightly, must be replaced immediately as it can no longer guarantee your safety.
- The fuses are protective elements. If you replace them with cheaper models or, even worse, with a metal element (copper wire, aluminium foil, etc.), you will no longer be protected against possible voltage surges on your installation.

CAT II: Measurements on circuits connected directly to the low-voltage installation.

Examples: domestic distribution system, portable or domestic appliances and equipment, mains power sockets.

CAT III: Measurements on the building's installation.

Examples: fixed installations involved in industrial distribution and the input circuits for electrical maintenance of a building (lighting, lift, etc.).

CAT IV: Measurements at the source of the low-voltage installation.

Examples: direct distribution circuit, primary sources, overhead-line and cable systems, including distribution busbars and the associated protective equipment against voltage surges.

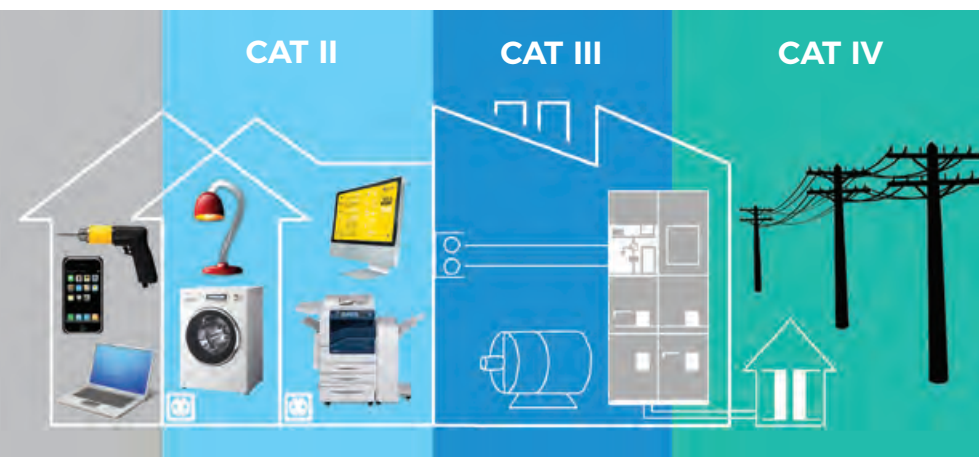

TECHNICAL REMINDERS

NUMBER OF COUNTS (FOR MEASUREMENT)

This is one of the fundamental specifications of instruments using analogue-digital conversion. It is usually used to define **the measurement range and the resolution**, on the basis of the value chosen as the rated calibre.

MEASUREMENT RANGE

This indicates the limits within which a digital instrument maintains its specified characteristics. The measurements obtained are not subject to an error greater than the maximum tolerated error. It is defined by a minimum measurable value and a maximum measurable value.

RATED CALIBRE

The calibre of an instrument is **the value of the quantity to be measured** which corresponds to the upper limit of the measurement range. For example, for an ammeter, if this upper limit is 5 A, its calibre is said to be 5 A.

RESOLUTION

This is the **smallest measurable value difference**. It is also **the value of one measurement count** or unit of quantification which is usually termed the "unit".

MINIMUM MEASURABLE VALUE (OR THRESHOLD)

This is **the smallest measurable value**. For an instrument with excellent conversion linearity, it may be the same as the resolution. This is not always the case and the manufacturer should indicate it clearly, because **this minimum value also depends on the accuracy**, and particularly on the constant error. When the constant error is too high, it becomes impossible to obtain valid measurements of very low values.

RMS: ROOT MEAN SQUARE

The term RMS (Root Mean Square) refers to the effective value. By definition, the effective value of any current is **the value of the DC current which would produce the same heating when flowing through a resistor**

$$V_{\text{rms}} = \sqrt{\frac{1}{T} \int_0^T V(t)^2 dt}$$

In the specific case of a sinusoidal quantity, application of the relation above gives:

$$V = V_{\text{peak}} \cos \omega t$$

$$V_{\text{rms}} = \sqrt{\frac{1}{T} \int_0^T V_{\text{peak}}^2 \cos^2(\omega t) dt} = \frac{V_{\text{peak}}}{\sqrt{2}}$$

The amplitude (V_c) of a voltage or of a sinusoidal current is equal to $\sqrt{2}$ times its RMS value ($V_c = \sqrt{2} V_{\text{RMS}}$). **It is crucial to know this RMS value in industrial environments**; it is this value which is used to define a current.

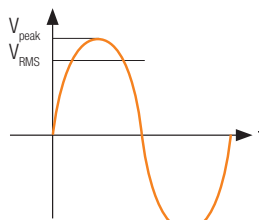

Thus, for the 230 V / 50 Hz mains network:

$$\begin{aligned} V_{\text{RMS}} &= 230 \text{ V} \\ V_{\text{peak}} &= 325 \text{ V} \\ V_{\text{avg}} &= 207 \text{ V} \end{aligned}$$

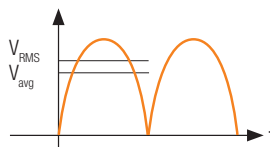

For a sinusoidal A voltage:

$$\begin{aligned} V_{\text{peak}} &= V_{\text{RMS}} \times \sqrt{2} \\ V_{\text{avg}} &= 0.9 V_{\text{RMS}} \end{aligned}$$

An "average value" measuring instrument measures the average value of a sinusoidal current, after rectification and filtering, and displays the RMS value after applying a coefficient of $1/0.9 = 1.111$

This indirect measurement method is simple and accurate but only valid for an undistorted sinusoidal current. It only tolerates distortion of a few percent.

This is why **"RMS" measuring instruments are increasingly widely used**. They rely on direct measurement principles:

the thermal method (used mainly in metrology) and analogue or digital calculation methods requiring sophisticated electronic components.

PEAK VALUE - CREST FACTOR

The crest factor is expressed as follows $CF = V_{\text{peak}} / V_{\text{rms}}$. This information complements the RMS value, allowing you to assess the distortion of a signal in qualitative terms.

For a sinusoidal signal, $CF = \sqrt{2} = 1.414$

ADVICE

When we speak of a 230 V network voltage, we are referring to an RMS value. For many years, the level of distortion caused by linear loads (incandescent lamps, heating) connected to the network was very low. The spread of non-linear loads (switching power supplies, light dimmers, variable speed-drives or compact fluorescent lamps) is calling this approach into question, as "pure" sinusoidal currents are becoming increasingly rare on the network.

Conventional measuring instruments (calculating the RMS value from the average value) are only accurate with sinusoidal currents, as a matter of principle. Otherwise, the measurement error may be as high as 50 %!

You are advised to opt for "RMS" measuring instruments which are capable of providing correct measurements, whatever the waveform of the current or voltage.

CHOOSE YOUR TESTER



	CA 732 page 16	CA 745N page 17	CA 755 page 17	CA 757 page 17
Strengths	Built-in torch Moulded body for exceptional handling	Phase test with a single test probe Continuity and resistance test	Casing with built-in compartment for stowing the test probes Measurements up to 1,000 V	MiniFlex® measurement accessory supplied Measurements up to 1,000 V
Display	LEDs	LCD bargraph	Backlit digital display	Backlit digital display
Single-pole phase detection		■		
No-contact phase detection	■		■	■
AC or DC voltage detection		■	■	■
Audible continuity		■	■	■
Resistance		■	■	■
Diode			■	■
Capacitance			■	■
Current				■
Removable test probe		■	■	■
600V CAT III		■	■	■
1000V CAT III	■			

CA 732

REF. : P01191745Z

 1000 V
CAT III

★ STRENGTHS

- No contact phase detection
- Built-in torch
- Moulded body for exceptionally comfortable handling



⚙️ SPECIFICATIONS

	CA 732
Detection threshold	195 V _{AC} ≤ U ≤ 265 V _{AC}
Audible beep	U > 230 V
Operating frequency	50/60 Hz
Standards	IEC 61010 1000 V CAT III
Power supply	2 x 1.5 V LR03 batteries
Dimensions / weight	176 x 26 mm / 48 g

📦 CONTENTS

CA 732 delivered in blister pack with 2 x 1.5 V LR03 batteries

⚙️ ACCESSORIES / REPLACEMENT PARTS

1.5 V LR03 battery

P01296032

CA 745N

REF. : PO1191743Z

 600 V
CAT III

 IP
54

★ STRENGTHS

- No risk of tripping high-sensitivity RCDs during phase/earth testing

⚙️ SPECIFICATIONS

	CA 745N
Voltage test	12 V to 690 V~ (7 segments)
Audible beep	U > 50 V~
Impedance	400 kΩ
Phase/neutral identification	Flashing "Ph" diode and intermittent audible beep for U > 100 V~
Operating frequency	DC and 50/60 Hz
Polarity test	"+" and "-" symbols
Voltage protection	Up to 1,100 V
Audible continuity test	R < 2 kΩ
Resistance test	2 kΩ to 300 kΩ (3 segments)
Standards	IEC 61010 600 V CAT III
Power supply	2 x 1.5 V LR03 batteries
Dimensions / weight	180 x 52 x 45 mm / 200 g

📦 CONTENTS

CA 745N delivered in a blister pack with 2 x 1.5 V LR03 batteries, 2 removable test probes (red/black)

⚙️ ACCESSORIES / REPLACEMENT PARTS

1.5 V LR03 battery	P0129603Z
1 set of CAT III/IV test probes (red/black)	P01102152Z
Set of red/black test probes, Ø 2 mm, CAT II	P01102153Z
Set of red/black test probes, Ø 4 mm, CAT II	P01102154Z
CA 753 universal measuring adapter for 2P+E sockets	P01191748Z
Velcro strap x 5	P01102113
Bag compatible with MultiFix accessory, 120 x 200 x 60 mm	P01298074
MultiFix mounting accessory	P01102100Z

CA 755 - CA 757

REF. : PO1191755

REF. : PO1191757

 600 V
CAT III

 IP
54

★ STRENGTHS

- Measurements up to 1,000 V
- Backlit digital display
- Built-in compartment for stowing test probes in casing
- CA 757: MiniFlex® current measurement accessory supplied

⚙️ SPECIFICATIONS

	CA 755	CA 757
Current test		
Measurement range via current sensor		500 mA to 300 A (2 calibres)
Resolution		0.01 A to 0.1 A
DC voltage		
Measurement range	3 mV to 1,000 V – 4 calibres	
Resolution	1 mV to 1 V	
AC voltage		
Measurement range	100 mV to 1,000 V – 4 calibres	
Resolution	1 mV to 1 V	
Operating frequency	DC and 50/60 Hz	
Impedance	10 MΩ	
No-contact voltage detection	230 V 50/60 Hz at a distance of approx. 5 cm	
Audible continuity test	R ≤ 30 Ω	
Resistance test		
Measurement range	0,3 Ω to 30 MΩ – 6 calibres	
Resolution	0.1 Ω to 0.01 MΩ	
Capacitance test		
Measurement range	400 pF to 30 mF	
Resolution	0.001 nF to 0.01 mF	
Standards	600 V CAT III, IEC 61010-1, IEC 61010-031, IEC 61010-032, IEC 61010-033	
Power supply	2 x 1.5 V LR03 batteries	
Battery life	100 hours with alkaline batteries – Automatic standby after 10 minutes	
Dimensions / weight	180 x 52 x 45 mm / 200 g	

📦 CONTENTS

- CA 755 delivered with 1 set of extra-fine test probes CAT III/CAT IV (red/black), 2 x 1.5 V LR3 alkaline batteries
- CA 757 delivered with 1 set of extra-fine test probes CAT III/CAT IV (red/black), 2 x 1.5 V LR3 alkaline batteries, 1 MiniFlex® sensor with a loop length of 250 mm, a connection cable 1 m long and a specific connector for CA 757, 1 Velcro strap

⚙️ ACCESSORIES / REPLACEMENT PARTS

1 set of test probes (red/black) CAT III / IV	P01102152Z
1.5 V LR03 battery	P0129603Z
See all the accessories on page 32	

CHOOSE YOUR VOLTAGE DETECTOR / VOLTAGE ABSENCE TESTER



	CA 742 / IP2X page 19	CA 762 / IP2X page 19	CA 771 / IP2X page 20	CA 773 / IP2X page 20
600V CAT IV	■	■		
1000V CAT IV			■	■
IP2X version	■	■	■	■
Single-pole phase detection	■	■	■	■
AC or DC voltage test	■	■	■	■
Stray voltage detection			■	■
RCD tripping			■	■
Audible continuity	■	■	■	■
Extended continuity / resistance		■	■	■
"2-wire" phase rotation		■	■	■
Removable test probe	■	■	■	■
Compliant with IEC 61243-3	■	■	■	■
Built-in self-test	■	■	■	■
LED display	■	■	■	■
Digital display				■
Extended climatic class			■	
IP65	■	■	■	■

CA 742 - CA 742 IP2X | CA 762 - CA 762 IP2X

REF. : P01191742Z

REF. : P01191742D

REF. : P01191762Z

REF. : P01191762D

 600 V
CAT IV

 IP
65

 IEC
61243-3

 NF C
18-510

★ STRENGTHS

- Full integrated Autotest
- Voltage test up to 690 Vac (16 2/3 – 800 Hz) / 750 Vdc
- IP2X versions available, compliant with NF C 18-510
- Removable test probe and lead
- Phase-sequence testing up to 400 Hz

⚙️ SPECIFICATIONS

	CA 742	CA 762
Voltage detection		
Voltage	12 V _{AC} ≤ U ≤ 690 V _{AC} 12 V _{DC} ≤ U ≤ 750 V _{DC}	
Frequency	DC, 16 2/3 to 800 Hz	
Impedance	> 300 kΩ	> 400 kΩ
Max. current	3.5 mA _{RMS}	
Polarity indication	Yes	
Hazardous voltage indication	The red ELV (Extra Low Voltage) LED indicates when the voltage is higher than the SELV (Safety Extra Low Voltage); the higher the voltage, the faster it flashes.	
Phase / Neutral identification	Above 120* V (45 - 65 Hz) Above 400 V (16 2/3 - 45 Hz)	
Continuity with buzzer		
Trigger threshold	100 Ω typical (150 Ω max.)	
Extended continuity test	-	2 kΩ, 60 kΩ, 300 kΩ
Test current	≤ 1 mA	
Open-circuit voltage	≤ 3.3 V	
Protection	Up to 1,000 V	
Phase rotation	No	2-wire method
Ph/Ph voltage	-	50 V ≤ U ≤ 690 V _{AC}
Frequency	-	Between 45 and 400 Hz
Buzzer	Intermittent beep for voltage detection and continuous beep for continuity	
Standards and electrical safety	IEC 61010 600 V CAT IV IEC 61243-3 Ed.2 concerning Voltage Detectors IEC 61326-1, emissions and immunity in industrial environments	
Ingress protection of enclosure	Casing: IP65 Test probes (option): IP2X	
Climatic conditions	Use from -15 °C to +45 °C / 20 to 95 % RH	
Power supply	2 x 1.5 V (LR03) batteries	
Battery life	7,500 x 10 s measurements	7,000 x 10 s measurements
Dimensions / weight	163 x 64 x 40 mm / 210 g	

* Typical value with standard individual protective equipment

⊕ ADDITIONAL INFO

- Don't forget the adapter for 2P+E sockets
CA 751 P01101997Z



📦 CONTENTS

- 1 voltage detector delivered with:
- 1 black Ø 2 mm test-probe lead with crystal safety cap
- 1 red Ø 2 mm test-probe lead with crystal safety cap
- 1 wrist-strap
- 2 x 1.5 V LR03 batteries

The IP2X version is delivered with:

- 2 x Ø 4 mm IP2X test probes (red/black)
- 1 black cable 1.10 m long equipped with a probe-holder system
- 1 wrist strap
- 2 x 1.5 V LR03 batteries

⚙️ ACCESSORIES / REPLACEMENT PARTS

Red test probe Ø 2 mm	P01102008Z
Crystal safety cap for Ø 2 mm test probe (x10)	P01102033
See all the accessories on page 32	

CA 771 - CA 771 IP2X | CA 773 - CA 773 IP2X

REF. : P01191771

REF. : P01191771A

REF. : P01191773

REF. : P01191773A

1000V
CAT IV

IP
65

IEC
61243-3

NF C
18-510



★ STRENGTHS

- Full Autotest with indication of the type of fault
- Lighting of the point of measurement
- Automatic standby
- Extended climatic class
- IP2X version available, compliant with NF C 18-510

⚙️ SPECIFICATIONS

	CA 771	CA 773
Display	LEDs	LEDs + Backlit digital display
Voltage detection	<p>Voltage 12 V_{AC} ≤ U ≤ 1000 V_{AC} 12 V_{DC} ≤ U ≤ 1400 V_{DC}</p> <p>Frequency DC, 16_{2/3} to 800 Hz</p> <p>Impedance > 500 kΩ</p> <p>Max. current 3.5 mA RMS</p> <p>Indication of polarity Yes</p>	
Stray voltage detection	Yes (by low-impedance load switching)	
RCD tripping	Yes (by low-impedance load switching) Approx. 30 mA to 230 V	
Redundant hazardous voltage indication	The ELV (Extra Low Voltage) LED indicates a voltage higher than the SELV (Safety Extra Low Voltage) with the flashing rate proportional to the voltage	
Phase / neutral identification	Above 50 V (45 - 65 Hz) Above 150 V (16 _{2/3} - 45 Hz)	
Continuity & resistance	<p>Buzzer trigger threshold 100 Ω typical (150 Ω max.) 100 Ω typical (150 Ω max.)</p> <p>Extended continuity test (resistance) 2 kΩ, 60 kΩ, 300 kΩ 0.5 Ω to 2.999 kΩ</p> <p>Test current / open-circuit voltage ≤ 1 mA / ≤ 3.3 V</p>	
Phase rotation	2-wire method	
Ph/Ph voltage	50 V ≤ U ≤ 1000 V _{AC} (45 - 400 Hz)	
Buzzer	Intermittent beep for voltage detection / Continuous beep for continuity	
Standards and electrical safety	IEC 61243-3:2009, EN 61243-3:2010 IEC 61010 1000 V CAT IV	
Enclosure ingress protection	IP65	
Climatic conditions	-30 °C to +60 °C (extended "Class S")	-15 °C to +45 °C ("Class N")
Battery life	> 5,000 x 10s measurements	> 2,500 x 10s measurements
Dimensions / weight	228 x 60 x 39 mm (without test probe) / 350 g approx.	

⊕ ADDITIONAL INFO

- Don't forget the universal measurement adapter for testing your 2P+E power sockets
CA 753..... P01191748Z



📦 CONTENTS

- 1 voltage detector delivered with:
- 1 set of red/black Ø 2 mm removable test probes with crystal safety cap
- 1 test-probe protector
- 1 Velcro strap
- 2 x 1.5 V LR03 batteries

The IP2X version is delivered with:

- 1 set of red/black IP2X Ø 4 mm removable test probes with crystal safety cap
- 1 Velcro strap
- 2 x 1.5 V LR03 batteries

⚙️ ACCESSORIES / REPLACEMENT PARTS

CA 753 measurement adapter for 2P+E socket	P01191748Z
Bag	P01298076
See all the accessories on page 32	

CHOOSE YOUR ANALOGUE MULTIMETER



	CA 5001 page 22	CA 5003 page 22	CA 5005 page 22	CA 5011 page 22
Analogue	■	■	■	■
Digital				■
Anti-parallax mirror	■	■	■	
4,000-count display				■
Backlighting				■
TRMS AC + DC measurement method				■
Max.				■
Low-impedance calibre (LowZ)	■	■	■	
AC and DC current	■	■	■	■
Current with clamp			■	
µA calibre	■	■	■	
5 A calibre	■			
10 A calibre			■	■
15 A calibre		■		
Resistance	■	■	■	■
Audible continuity	■	■	■	■
Frequency				■
dB	■	■	■	■
Fuse status LED	■	■	■	■
Voltage presence LED in ohmmeter mode				■

CA 5001 - CA 5003 - CA 5005

REF. : P01196521E

REF. : P01196522E

REF. : P01196523E



600 V CAT III
IP 53



STRENGTHS

- “Fus” LED: HRC fuse check
- Volttest™ LED: voltage presence in ohmmeter* mode
- Automatic tare in ohmmeter mode*
- µA calibres
- Compact, shockproof casing with multi-purpose “Multistand™” articulated stand for CA 5003 and CA 5005

* for CA 5003 and CA 5005

SPECIFICATIONS

	CA 5001	CA 5003 ⁽¹⁾	CA 5005 ⁽¹⁾
DC voltage	8 calibres: 100 mV / ... / 1000 V ⁽²⁾		
AC voltage	5 calibres: 10 V / ... / 1000 V ⁽²⁾		
Internal resistance	20 kΩ/V		
Operating frequency	10 Hz ... 100 kHz depending on calibre		
DC current	5 cal.: 50 µA / ... / 5 A	7 cal.: 50 µA / ... / 15 A	6 cal.: 50 µA / ... / 10 A
AC current	4 cal.: 5 mA / ... / 5 A	5 cal.: 1.5 mA / ... / 15 A	5 cal.: 3 A / ... / 300 A ⁽⁴⁾
Resistance	2 cal.: 10 kΩ and 1 MΩ		
Audible continuity test	R < 50 Ω		
Scale in dB for Vac	0 ... +22 dB		
Typical accuracies ⁽⁴⁾	1.5% for V _{DC} • 2.5% for V _{AC} and A _{AC} • 10% for Ω		
Power supply	1 x 1.5 V LR06 battery	1 x 9 V 6LR61 battery	
Battery life	10,000 x 15 s measurements	10,000 x 10 s measurements	
Electrical safety ⁽⁶⁾	IEC 61010-1 Edition 2 600 V CAT III		
Protection ⁽⁶⁾	0.5 A and 5 A HRC fuses	1.6 A and 16 A HRC fuses	1 A and 10 A HRC fuses
Ingress protection	IP 40	IP 53	
Climatic conditions	-10 °C ... +55 °C and RH < 90 %		
Dimensions / weight	160 x 105 x 56 mm / 500 g		

(1) Additional “Volttest™” function to check for the possible presence of a voltage during resistance measurement and audible continuity test - (2) Use limited to 600 V max. (3) Limited to 240 A max. by the MN 89 miniclip - (4) In % of end-of-scale - (5) Degree of pollution 2 - (6) Electronic protection and HRC fuses for the current calibres with fuse test LED.

ADDITIONAL INFO

- Also delivered complete in a hard case:
CA 5001 case.....P01196521F
CA 5003 case.....P01196522F
CA 5005 case.....P01196523F
- The CA 5005 is delivered with a current clamp for measurements up to 200 AAC

CONTENTS

- CA 5001 delivered with 1 set of silicone straight banana plug/elbowed banana plug leads, 1 set of safety test probes, 1 x 1.5 V LR6 battery
- CA 5003 delivered with 1 set of silicone straight banana plug/elbowed banana plug leads, 1 set of safety test probes, 1 x 9 V 6LR61 battery
- CA 5005 delivered with 1 MN89 AC clamp, 1 set of silicone straight banana plug/elbowed banana plug leads, 1 set of safety test probes, 1 x 9 V 6LR61 battery

ACCESSORIES / REPLACEMENT PARTS

Accessories kit for electricians	P01295459Z
CM1214S current measurement lead	P03295509
See all the accessories on page 32	

CA 5011

REF. : P01196311E



600 V CAT IV
IP 53 TRMS



STRENGTHS

- Extra safety with 2 LEDs: “Fus”: HRC fuse test, “Volttest™”: voltage presence in ohmmeter mode
- Two complementary readings: digital for accuracy, with backlighting, and analogue for quick reading
- Automatic AC/DC recognition
- Compact, shockproof casing with multi-purpose Multistand™ articulated stand

SPECIFICATIONS

	CA 5011
DC and AC voltage	2 x 5 calibres: 400 mV / ... / 1000 V ⁽¹⁾
Impedance	10 MΩ
Operating frequency ⁽²⁾	20 Hz / ... / 10 kHz
DC and AC current	2 x 6 calibres: 400 µA / ... / 10 A
Resistance ⁽³⁾	6 calibres: 400 Ω / ... / 40 MΩ
Audible continuity test ⁽³⁾	R < 400 Ω
Frequency	3 calibres: 4 kHz / ... / 400 kHz
Scale in dB for Vac	-20 dB ... +16 dB
Max. value	Over 500 ms
Typical accuracies ⁽⁴⁾	1% for V _{DC} and Ω, 1.5 % for A _{CC}
Power supply	1 x 9 V 6LR61 battery
Battery life	300 hours
Electrical safety ⁽⁶⁾	IEC 61010-1 Edition 2 600 V CAT IV
Protection ⁽⁶⁾	1 A and 10 A HRC fuses
Ingress protection	IP 53
Climatic conditions	-10 °C ... +55 °C and RH < 90 %
Dimensions / weight	160 x 105 x 56 mm / 500 g

(1) Use limited to 600 V max. (2) Crest factor ≤ 5 - (3) Additional Volttest™ function to check for the possible presence of a voltage - (4) In digital mode. In analogue mode: 2.5 % - (5) Degree of pollution 2 - (6) Electronic protection and HRC fuses for the current calibres with fuse test LED.

ADDITIONAL INFO

- Also available delivered complete in hard case:
CA 5011 case.....P01196311F

CONTENTS

- 1 CA 5011 multimeter
- 1 set of silicone straight banana plug/elbowed banana plug leads
- 1 set of safety test probes
- 1 x 9 V 6LR61 battery

ACCESSORIES / REPLACEMENT PARTS

Accessories kit for electricians	P01295459Z
PVC test-probe lead with insulated elbowed male plug Ø 4 mm (x 2)	P01295456Z
See all the accessories on page 32	

CHOOSE YOUR DIGITAL MULTIMETER



	CA 702 page 24	CA 703 page 24	CA 5231 page 24	CA 5233 page 24	CA 5273 page 25	CA 5275 page 25	CA 5277 page 25	CA 5292 page 26	CA 5293 page 26
2000-count display	■	■							
6000-count display			■	■	■	■	■		
100,000-count display								■	■
Bargraph			■	■	■	■	■	■	■
Bi-mode bargraph (full scale – central zero)					■	■	■	■	■
Backlighting			■	■	■	■	■	■	■
AVG measurement method	■	■							
TRMS AC/DC measurement method			■	■	■	■	■	■	■
TRMS AC+DC measurement method						■	■	■	■
Autorangeing	■	■	■	■	■	■	■	■	■
Min				■	■	■	■	■	■
Max				■	■	■	■	■	■
Peak							■	■	■
AC and DC voltage up to 600 V	■	■							
AC and DC voltage up to 1,000 V			■	■	■	■	■	■	■
No-contact voltage detection	■	■	■	■					
Low-impedance calibre (LowZ)			■	■	■	■	■	■	■
LowZ voltage with low-pass filter					■	■	■	■	■
AC and DC current		■		■	■	■	■	■	■
Current with clamp			■					■	■
µA calibre		■				■	■	■	■
10 A calibre				■	■	■	■	■	■
Resistance	■	■	■	■	■	■	■	■	■
Audible continuity	■	■	■	■	■	■	■	■	■
Semi-conductor test	■	■	■	■	■	■	■	■	■
Frequency				■	■	■	■	■	■
Capacitance				■	■	■	■	■	■
dB								■	■
Temperature				■	■		■	■	■
USB communication								■	■
Data storage								10,000 measurements	30,000 measurements
CAT III 1000 V	■	■	■		■	■	■	■	■
CAT IV 600 V	■	■	■	■	■	■	■	■	■

CA 702 - CA 703

REF. : PO1191739Z

REF. : PO1191740Z



600 V
CAT IV
IEC
61010-2-033



STRENGTHS

- Pocket format
- Built-in test probes
- Easy to handle and safe
- Built-in torch

SPECIFICATIONS

	CA 702	CA 703
Display	2000 points	
Calibre selection	Automatic (AUTORANGE)	
V _{DC} / accuracy	200 mV / ± 0.5 % R + 3 D 2,000 V; 20.00 V; 200.0 V; 600 V / ± 1.2 % R + 3 D > 600 V / outside specifications	
V _{AC} / accuracy (40-400 Hz)	2,000 V; 20.00 V / ± 1.0 % R + 8 D 200.0 V; 600 V / ± 2.3 % R + 10 D > 600 V / outside specifications	
No-contact voltage detection	Yes	Yes
I _{DC} / accuracy Protection	200.0 µA; 2,000 µA ± 2.0 % R + 8 D 20.00 mA; 200.0 mA ± 2.0 % R + 8 D 200 mA / 500 V electronic fuse	
I _{AC} / accuracy Protection	200.0 µA; 2,000 µA ± 2.5 % R + 10 D 20.00 mA; 200.0 mA ± 2.5 % R + 10 D Protection 200 mA / 500 V Electronic fuse	
Resistance • Accuracy • Protection	200.0 Ω / ± 0.8 % R + 5 D • 2,000 kΩ, 20.00 kΩ, 200.0 kΩ / ± 1.2 % R + 5 D 2,000 MΩ / ± 5.0 % R + 5 D 20.00 MΩ / ± 10.0 % R + 5 D • 600 V _{RMS}	
Diode test • Test signal • Protection	1.999 V • V _{test} ≤ 1.5 V • I _{test} ≤ 1 mA • 600 V _{RMS}	
Audible continuity • Buzzer • Protection	199.9 Ω • R < approx. 60 Ω • 600 V _{RMS}	
Torch	Yes	Yes
Standards	IEC 61010 1000 V CAT III / 600 V CAT IV	
Power supply	2 x 1.5 V LR03 batteries	
Miscellaneous	Built-in test probe leads	
Dimensions / weight	104 x 55 x 32.5 mm / 145 g	

CONTENTS

CA 702 and CA 703 delivered with 2 x 1.5 V LR03 batteries

ACCESSORIES / REPLACEMENT PARTS

1.5 V LR03 battery	PO1296032
200 x 100 x 40 mm soft case	PO1298065Z

CA 5231 - CA 5233

REF. : PO1196731

REF. : PO1196733



1000 V
CAT III
600 V
CAT IV
IEC
61010-2-033
IP
54
TRMS



STRENGTHS

- Compact and ergonomic
- AC/DC voltage up to 1,000 V
- AC/DC current up to 600 A with 1,000/1 current clamp (option)

SPECIFICATIONS

	CA 5231	CA 5233
Display	6,000-count display + 61-segment bargraph	
Backlighting	Yes	
Acquisition	True RMS AC	
Autorange / Manual range	Yes / Yes	
Best accuracy	0.02 %	
AC voltage	6 calibres / 1,000 V / resolution: 0.01 mV Bandwidth: 45 Hz ... 1 kHz	
LowZ AC voltage	Yes	
DC voltage	6 calibres / 1000 V / resolution: 0.01 mV	
AC/DC current	With 1 AC or DC clamp (1 mV/A) as an option 1 calibre: 600 A Resolution: 0.1 A	2 calibres: 10 A / 6 A Resolution 0.001 A
Resistance measurement	6 calibres / 60 MΩ / resolution: 0.1 Ω	
Audible continuity	Yes	
Diode test	Yes	
Frequency	3 calibres: up to 3 kHz	
Duty cycle	Yes	
Capacitance	6 calibres / 1,000 µF Resolution: 0.01 nF	
Temperature	2 calibres -20 °C to 760 °C -4 °F to 1,400 °F Resolution: 0.1°	
No-contact voltage detection (NCV)	Yes	Yes
Display Hold	Yes	Yes
Relative mode	Yes	
Min-Max	Yes	
Power supply	1 x 9 V 6LR61 battery	
Ingress protection	IP54	
Standards	IEC 61010-1, IEC 61010-2-033 CAT IV 600 V / CAT III 1000 V	IEC 61010-1, IEC 61010-2-033 CAT IV 600 V / CAT III 600 V
Dimensions / weight	155 x 75 x 55 mm / 320 g	

ADDITIONAL INFO

- The CA 5231 can also be delivered complete with its MINI03 100 AAC current clamp: CA 5231 complete kit..... PO1196734

CONTENTS

CA 5231 delivered with:

- 1 set of red/black test-probe leads
- 1 x 9 V 6LR61 battery

CA 5233 delivered with:

- 1 set of red/black test-probe leads
- 1 TC-K adapter for DMM
- 1 wire K thermocouple
- 1 x 9 V 6LR61 battery

ACCESSORIES / REPLACEMENT PARTS

Accessories kit for electricians	PO1295459Z
PVC test-probe lead, insulated elbowed male plug Ø 4 mm (x 2)	PO1295456Z
See all the accessories on page 32	

CA 5273

REF. : PO1196773



TRMS **1000 V CAT III** **600 V CAT IV** **IEC 61010-2-033** **IP 54**



★ STRENGTHS

- Large 6,000-count display
- Double backlit display
- Temperature and capacitance measurements
- Bargraph central zero mode
- Min/Max memorization

⚙️ SPECIFICATIONS

	CA 5273
Display	2 x 6,000 counts – backlit
Bargraph (63 elements)	Bi-mode (full scale / central zero)
Acquisition	TRMS AC / DC
Measurement range	5 measurements / second
Autoranging	Yes
Manual ranges	Yes
AC/DC voltage	600.0 mV / 6.000 V / 60.00 V / 600.0 V / 1000 V
Typical accuracy (V _{ac})	0,2% + 2 cts
Bandwidth (V _{ac})	40 Hz to 3 kHz
LowZ AC voltage	Low-impedance setting with low-pass filter
AC/DC current	6.000 A / 10.00 A (20 A/30 s)
Resistance measurement	600.0 Ω / 6000 Ω / 60.00 kΩ / 600.0 kΩ / 6.000 MΩ / 60.00 MΩ
Audible continuity / Diode test	Yes / Yes
Frequency	600.0 Hz / 6.000 kHz / 50.00 kHz
Capacitance	8 cal.: 6.000 nF to 60.00 mF
Temperature	-59.6 °C to +1200°C -4°F to 2192 °F
Hold	Yes
Min / Max (100 ms)	Yes
Automatic power-off	Yes (deactivatable)
Safety	IEC 61010-1, IEC 61010-2-033 CAT IV 600 V / CAT III 1000V
Ingress protection	IP54
Power supply	1 x 9V 6LR61 battery
Dimensions / weight	90 x 190 x 45 / 400 g

⊕ ADDITIONAL INFO

- 5 measurements / s
- 12-bit converter
- 3-year warranty

📦 CONTENTS

CA 5273 delivered with:

- 1 set of banana leads
- 1 set of test probes
- 1 x 9 V 6LR61 battery
- 1 K-thermocouple temperature sensor

🔧 ACCESSORIES / REPLACEMENT PARTS

Accessories kit for electricians	P01295459Z
PVC lead with test probe, elbowed Ø 4 mm insulated male plug (x 2)	P01295456Z

See all the accessories on page 32

CA 5275 - CA 5277

REF. : PO1196775

REF. : PO1196777



TRMS AC+DC **1000 V CAT III** **600 V CAT IV** **IEC 61010** **IP 54**



★ STRENGTHS

- 10 µV resolution
- Current measurement from 1 µA
- Measurement of ionization currents
- Min / Max / Peak+ / Peak- acquisition
- Differential (ΔX) and relative (ΔX / X%) measurements

⚙️ SPECIFICATIONS

	CA 5275	CA 5277
Display	2 x 6,000 counts, backlit	
Bargraph	63 elements, bi-mode (full scale / central zero)	
Acquisition	TRMS AC / DC / AC+DC	
Measurement rate	5 measurements / second	
Automatic / Manual ranges	Yes / Yes	
AC/DC/AC+DC voltage	60.00 mV / 600.0 mV / 6 V / 60.00 V / 600.0 V / 1000 V	
Typical accuracy (V _{ac})	0.09% + 2 cts	
Bandwidth (V _{ac})	40 Hz to 10 kHz	
LowZ AC voltage	Low-impedance setting with low-pass filter	
AC/DC/AC+DC current	6000 µA / 60.00 mA / 600.0 mA / 6.000 A / 10.00 A (20A/30s)	
Ionization current	0.2 µA to 20.0 µAcc	
Resistance measurement	600.0 Ω / 6000 Ω / 60.00 kΩ / 600.0 kΩ / 6.000 MΩ / 60.00 MΩ	
Audible continuity / Diode test	Yes / Yes	
Frequency	600.0 Hz / 6.000 kHz / 20.00 kHz	
Capacitance	6.000 nF / 60 nF / 600 nF / 6 µF / 60 µF / 600 µF / 6 mF / 60 mF	
Temperature	No	-59.6 °C to +1200 °C -4°F to 2192 °F
Hold	Yes	
Min / MAX (100 ms)	Yes	
Peak+ / Peak- (1 ms)	No	Yes
Differential (ΔX) / RELative (ΔX/X%) measurements	No	Yes
Automatic power-off	Yes (deactivatable)	
Safety	IEC 61010-1, IEC 61010-2-033 CAT IV 600 V / CAT III 1000 V	
Ingress protection	IP54	
Power supply	1 x 9V 6LR61 battery	
Dimensions / weight	90 x 190 x 45 / 400 g	

⊕ ADDITIONAL INFO

- 5 measurements / s
- 12-bit converter
- 3-year warranty

📦 CONTENTS

- CA 5275 delivered with a set of banana plugs, a set of test probes, a 9 V battery, a shoulder bag, a MultiFix mounting accessory and a quick start guide
- CA 5277 same as CA 5275 plus a K-thermocouple temperature sensor

🔧 ACCESSORIES / REPLACEMENT PARTS

Accessories kit for electricians	P01295459Z
PVC lead with test probe, insulated elbowed male plug Ø 4 mm (x 2)	P01295456Z

See all the accessories on page 32

CA 5292 - CA 5293 | CA 5292BT - CA 5293BT

REF. : PO1196802

REF. : PO1196803

REF. : PO1196812

REF. : PO1196813



STRENGTHS

- 320 x 240 pixels colour liquid crystal matrice screen, high readability, black background
- Data storage: 30,000 measurements (CA 5293) and 10,000 measurements (CA 5292)
- Adjustable backlit screen
- Multiple analytical tools: time/date-stamped MIN/MAX/AVG and PEAK
- Bandwidth: 200 kHz
- Basic accuracy: 0.02 %
- Multi-parameter display: 1 main and 3 secondary measurements
- 4 x 100,000-count displays and TRMS AC+DC converter



CONTENTS

CA 5292, CA 5292BT and CA 5293, CA 5293BT delivered with:

- 1 bag
- 4 x NiMH 2400 mAh 1.5 V rechargeable batteries
- 1 USB charger
- 1 set of 2 x 1.5 m straight/straight, red / black cables
- 1 set of red/black CAT IV 1 kV test probes
- 1 USB optical cable
- SX-DMM software

ACCESSORIES / REPLACEMENT PARTS

MTX329X calibration software	HX0059B
Kit of 4 NiMH batteries	HX0051B

ADDITIONAL INFO

- Battery life of up to 100 hours
- SX-DMM software (supplied) for real-time processing of the results on a PC
- Android application available from GOOGLE PLAY
- Waveform mode for viewing an automatic waveform from 10Hz to 600Hz

SPECIFICATIONS

- Bandwidth: 100 kHz to 200 kHz
- Temperature measurement with K/J thermocouple or Pt sensor from -200 °C to +1200 °C
- Current measurement by direct reading with clamp (integration of the ratio)
- Numerous additional measurement functions: low-pass PWM filter (variable speed drive), VLowZ low impedance (500 kΩ), dB/dBm measurement, duty cycle, pulses, diode tests: Zener or LED...
- A "reference" multimeter with 100 kcts and display of its specifications associated with a RELative mode
- Simplified parameterization of the number of measurements, the interval (0.2 s to 24 hrs), the duration, the memory capacity, etc.
- Internal storage: up to 30 measurement sequences (CA 5293)
- Zoom function on stored curves
- USB or Bluetooth communication depending on models

CA 5292 / CA 5292BT	CA 5293 / CA 5293BT
---------------------	---------------------

Display	4 x 100,000 counts, TRMS	
Bargraph	40 elements or central zero mode	
Measurement rate	5 measurements /second	
DC, AC and AC+DC voltages		
Measurement range	10µV to 600VAC/1,000V DC	
Calibres	100 mV* / 1,000 mV / 10 V / 100 V / 1,000 V	
Resolution	1 µV / 10 µV / 0.1 mV / 1 mV / 10 mV	
DC accuracy	0.03 %	0.02 %
AC and AC+DC bandwidth	100 kHz	200 kHz
AC and AC+DC accuracy	0.3 %	0.3 %
VLowZ AC	500 kΩ	
DC, AC and AC+DC current		
Measurement range	100µA to 20A (30s)	
Calibres	1,000 µA / 10 mA / 100 mA / 1,000 mA / 10 A / 20 A (30 s max)	
Resolution	10 nA / 0.1 µA / 1 µA / 10 µA / 100 µA / 1,000 µA	
DC accuracy	0.08 %	
AC and AC+DC bandwidth	50 kHz	
AC and AC+DC accuracy	0.3 %	
Frequency		
Measurement range	1Hz to 5MHz	
Frequency calibres	10 Hz / 100 Hz / 1 kHz / 10 kHz / 100 kHz / 1 MHz / 5 MHz	
Resolution	0.0001 Hz / 0.001 Hz / 0.01 Hz / 0.1 Hz / 1 Hz / 10 Hz / 100 Hz	
Resistance and continuity		
Resolution	10mΩ to 100MΩ	
Calibres	100 Ω* / 1 kΩ / 100 kΩ / 1,000 kΩ / 10 MΩ / 100 MΩ	
Resolution	0,001 Ω / 10 mΩ / 100 kΩ / 10 Ω / 10 Ω / 1 kΩ	
Basic accuracy	0.07 %	
Audible continuity detection	< 20 Ω	
Diode test		
Voltage measurement	Diodes in open circuit < 26 Vmax at 10 mA	
Capacitance		
Measurement range	1pF to 10mF	
Calibres	1 nF / 10 nF / 100 nF / 1,000 nF / 10 µF / 100 µF / 1 mF / 10 mF	
Resolution	1 pF / 10 pF / 0.1 nF / 1 nF / 0.01 µF / 0.1 µF / 1 µF / 10 µF	
Temperature with Pt100/1000 and K/J thermocouples		
Operating ranges	-200 °C to +800 °C with Pt and -40 °C to +1200 °C with K thermocouple	
Accuracy	0.1 %	
Other functions		
MAX/MIN/AVG - PEAK	On all the main time/date-stamped quantities - Secondary measurement	
REL	Relative value: REF - Main measurement	
PWM filter	4th-order 300 Hz low-pass filter for measurements on variable speed drives of asynchronous motors	
SPEC	Display of measurement tolerance + Smin + Smax	
GRAPH	Trend of the main measurement on variable time base from 1min 28s à 1h 13min 20s	
WAVEFORM	Graphical display of a signal up to 600 Hz in auto mode	
Secondary measurements	3 measurements + main measurement	
Measurement storage	10,000	30,000
General specifications		
Type of display	Colour graphical display (70 x 52) with backlighting and black background on 4 x 100,000 count displays	
PC interfaces*	USB optical connector or Bluetooth (option) – SX-DMM software	
Power supply	Charger or 4 x AA batteries or NiMH rechargeable batteries	
Safety / EMC	Safety as per IEC61010-1 - 1000 V CAT III - EMC as per EN61326-1 IEC 61010-2-033 - 1000 V CAT III - 600 V CAT IV	
Environment	Storage -20 °C to +70 °C – Operation 0 °C to +40 °C	
Mechanical specifications	Dimensions (L x D x H): 196 x 90 x 47.1 mm / Weight: 570 g	
Ingress protection	IP67	

* Manual access

CA 922 - CA 942

REF. : P01192200

REF. : P01194200

600 V
CAT III



TRMS

TRMS
AC+DC

IEC
61010



3 in 1



STRENGTHS

- 20 or 40 MHz oscilloscope with 2 channels
- Double 8,000-count multimeter
- Double harmonic analyser
- 3.5" colour LCD optimized for maximum display
- Integrated multilingual interactive help function
- Recording and recovery of data on PC
- Practical with its USB communication using the SCPI protocol
- Stand-alone, powered by NiMH battery with USB charger

ADDITIONAL INFO

- The same connection technology is used for all the modes: 2 BNC inputs for sensor or BNC/banana adapter delivered

CONTENTS

CA 922 and CA 942 depending on model:

- BNC-Banana adapters: 2 for the CA 922, 1 for the CA 942
- Set of straight-elbowed moulded PVC cables (red/black) 1.5 m long: 2 for the CA 922, 1 for the CA 942
- Set of red/black crocodile clips: 2 for the CA 922, 1 for the CA 942
- 1 x 1/10 600V sensor for the CA942
- Set of red/black CAT IV 1000V test probes: 2 for the CA 922, 1 for the CA 942
- Jack-USB cable + USB WALLPLUG
- USB optical cable
- Bag

ACCESSORIES / REPLACEMENT PARTS

PWM kit = MLI01 filter + E27N clamp	P01102188
Calibration software	HX0099
Power supply kit with jack/USB cable and USB charger	P01103080
SX METRO software: SX-METRO/P	SX-METRO/P
BNC accessories, see page	153 - 217

SPECIFICATIONS

Complete oscilloscope

- 2 x 600V CAT III isolated channels, display of automatic measurements and cursors
- Simple MATH functions (+, -, x, / inversion) with automatic scaling
- Fast Autoset in <5 s, range >10 Hz from 10 mVpp to 400 Vpp
- Simple or complex triggering on edge or pulse, associated with HF or LF filters
- Acquisition with different modes: peak detect, averaging or envelope, as well as time-based zoom function.

2 independent 8,000-count TRMS digital multimeters

AC, DC and AC+DC voltage and current measurements, resistance, continuity, capacitance, frequency and power values (combination of two measuring channels), as well as temperature (K thermocouple or infrared sensor), motor rotation speed (optical tachometer), testing of diodes and components and single-phase or balanced three-phase power measurements.

2 channels for Harmonic Analysis

2 channels up to the 31st order, with a fundamental frequency between 40 and 450 Hz. Display of total VRMS, THD and the harmonic order selected (%fundamental, phase, frequency, VRMS).

Data storage— Communication & PC software SX-METRO

	CA 922	CA 942
HMI		
Type of display	3.5" colour TFT – Resolution 320x240 – LED backlighting	
Display mode	2,500 real on-screen acquisition points	
Display of curves on screen	2 curves + 2 references + memory trace or mathematical calculation	
Controls	Direct adjustments on front panel & on-screen menus via browser (main & secondary without "hidden menus")	
Integrated interactive help function	14 languages: English, French, German, Spanish, Italian, Swedish, Romanian, Russian, Finnish, etc.	
OSCILLOSCOPE MODE		
Vertical deflection		
Bandwidth	20 MHz	40 MHz
Bandwidth limiter	1.5 MHz, 5 kHz	
Number of channels	2 totally isolated channels	
Input impedance	1 MΩ ±0.5%, approx. 17 pF	
Maximum input voltage	600 V CAT III – Derating -20 dB per from 100 kHz	
Vertical sensitivity	5 mV to 200 V/div	
Horizontal deflection		
Sweep speed	25 ns/div to 200 s/div – Roll mode: 100 ms to 200 s/div	
Horizontal zoom	Zoom factor: x1, x2, x5	
Triggering		
Mode	Automatic, triggered, one-shot & Triggered Roll	
Type	Edge, pulse width (20 ns – 20 s)	
Coupling	AC or DC (depending on coupling of triggering channel); HF, LF or noise rejection	
Sensitivity	≤ 1.2 divisions peak-peak up to 20 MHz	≤ 1.2 divisions p-p up to 40 MHz
Digital data storage		
Maximum sampling rate	2 GS/s in ETS mode – 50 MS/s in one-shot mode on each channel	
Vertical resolution	9 bits	
Memory depth	2,500 points per channel	
User storage	2 MB for storing the files: trace (.trc), text (.txt), configuration (.cfg), image files (.bmp)	
GLITCH mode	Duration ≥ 20 ns – 1,250 Min/Max pairs	
Display modes	Envelope, Averaging (factors 2 to 64) and XY (vector)	
Other functions		
MATH functions	Channel inversion, addition, subtraction, multiplication and division (adjustable scaling)	
Cursor measurements	2 cursors: simultaneous V, T, dV and dt – 4-digit display resolution	
Automatic measurements	18 time-based or level measurements, phase measurement	
MULTIMETER MODE		
General specifications		
General specifications	2 channels, 8,000-count display + min/max bargraph Graphical recording of 2,700 measurements (5 min to 1 month)	
Operating modes	Absolute or relative display (absolute, deviation, ref. ref%) Monitoring (instantaneous, Min, Max, Avg)	
AC, DC and AC+DC voltage	Ranges from 600 mV to 600 VRMS, 800 mV to 800 VDC – VDC accuracy: 1%R +20D – 50 kHz bandwidth	
Resistance	Range from 80 Ω to 32 MΩ - Accuracy 2%R+10D – 10 ms quick continuity test	
Capacitance	Ranges from 5 nF to 5 mF – Basic accuracy 2%R+10D	
Other measurements	Frequency, rotation speed, 3.3 V diode, temperature measurement (using K thermocouple and infrared sensor)	
POWER		
Measurements	Single-phase and balanced three-phase active power values (with or without neutral), simultaneous display of current - PF	
HARMONICS MODE		
Multi-channel analysis	2 channels, 31 orders, frequency of fundamental from 40 to 450 Hz	
Simultaneous measurements	Total VRMS, THD and selected order (%fundamental, phase, frequency, VRMS)	
GENERAL SPECIFICATIONS		
Screenshots	Up to 100 files in standard ".bmp" format, viewable on the instrument	
PC communication	Isolated optical USB interface – SX-Metro application software for PC available as an option	
Power supply	6 x Lr6 batteries or 6 x type-AA NiMH rechargeable batteries Battery life up to 8.5 hours JACK/USB cable with adapter – Fast charging in 3 hours	
Safety / EMC	Safety as per IEC61010-1 Ed3 – 600 V CAT III – EMC as per EN61000-3, 2001 & EN61326-1, 2006	
Mechanical specifications	214 x 110 x 57 mm – 1.2 kg with batteries – moulded elastomer casing	

MA400D-170 - MA400D-250 - MA4000D-350

REF. : P01120575Z

REF. : P01120576Z

REF. : P01120577Z

 600V
CAT IV

TRMS



★ STRENGTHS

- Compact, lightweight and simple to use
- Direct current readings
- Measurement from a few tens of mA
- MAX HOLD to store the maximum value

⚙️ SPECIFICATIONS

	MA400D-170 / 250		
Display range	4 A _{AC}	40 A _{AC}	400 A _{AC}
Measurement range	0.020 A ... 3.999 A	4.00 A ... 39.99 A	40.0 A ... 399.9 A
Resolution	1 mA	10 mA	100 mA
Accuracy	± (2% + 10 cts)	± (1.5% + 2 cts)	± (1.5% + 2 cts)
Clamping diameter / sensor length	MA400D-170: Ø 45 mm / 170 mm MA400D-250: Ø 70 mm / 250 mm		
Bandwidth	10 Hz ... 3 kHz		
Power supply	2 x 1.5 V AAA / LR batteries		
Safety	IEC 61010 CAT IV 600 V		
Operating temperature	0°C to +50°C		
Instrument weight	Approximately 130 g		
Casing dimensions	100 x 60 x 20 mm		
Length of built-in connection cable	0.8 m		

	MA4000D-350		
Display range	40 A _{AC}	400 A _{AC}	4000 A _{AC}
Measurement range	0.2 A ... 39.99 A	40.0 A ... 399.9 A	400 A ... 3999 A
Resolution	10 mA	100 mA	1 A
Accuracy	± (2% + 10 cts)	± (1.5% + 2 cts)	± (1.5% + 2 cts)
Clamping diameter / sensor length	MA4000D-350: Ø 100 mm / 350 mm		
Bandwidth	10 Hz ... 3 kHz		
Power supply	2 x 1.5 V LR06 batteries		
Safety	IEC 61010 CAT IV 600 V		
Operating temperature	0°C to +50°C		
Instrument weight	Approximately 130 g		
Casing dimensions	100 x 60 x 20 mm		
Length of built-in connection cable	0.8 m		

⊕ ADDITIONAL INFO

- MA400D: measurement from 20 mA AC



📦 CONTENTS

- 1 ammeter delivered with:
- 2 x 1.5 V LR06 batteries
 - 1 Velcro mounting strap

⚙️ ACCESSORIES / REPLACEMENT PARTS

Bag 120 x 200 x 60	P01298074
MULTIFIX accessories	P01102100Z
See all the accessories on page 32	

CHOOSE YOUR CLAMP MULTIMETER



	F201 page 30	F203 page 30	F205 page 30	F401 page 31	F403 page 31	F405 page 31	F407 page 87	F603 page 31	F605 page 31	F607 page 87
Clamping Ø 34 mm	■	■	■							
Clamping Ø 48 mm				■	■	■	■			
Clamping Ø 60 mm								■	■	■
AC current	■	■	■	■	■	■	■	■	■	■
DC current		■	■		■	■	■	■	■	■
Automatic DC Zero		■	■		■	■	■	■	■	■
True Root Mean Square (TRMS) measurements	■	■	■	■	■	■	■	■	■	■
Measurement with DC component (AC+DC)			■		■	■	■		■	■
Measurement on non-linear loads	■	■	■	■	■	■	■	■	■	■
6,000-count display	■	■	■							
10,000-count display				■	■	■	■ x 3	■	■	■ x 3
Backlighting		■	■	■	■	■	■	■	■	■
AC and DC voltage measurement	■	■	■	■	■	■	■	■	■	■
Resistance	■	■	■	■	■	■	■	■	■	■
Audible continuity	■	■	■	■	■	■	■	■	■	■
Semi-conductor test	■	■	■	■	■	■	■	■	■	■
Frequency	■	■	■	■	■	■	■	■	■	■
Temperature	■	■		■	■			■		
Active power (W)			■			■	■		■	■
Apparent and reactive power (VA, var)			■			■	■		■	■
Power Factor (PF/DPF)			■			■	■ ■		■	■ ■
AC / DC / AC+DC power measurements			■			■	■		■	■
Phase rotation (2 wires)			■			■			■	
Total Harmonic Distortion (THDf% / THDr%)			■			■	■		■	■
Harmonic decomposition Harm0...Harm25							■			■
Crest Factor (CF)							■			■
Deactivatable automatic AC/DC	■	■	■	■	■	■	■	■	■	■
Motor InRush	■	■	■	■	■	■	■	■	■	■
Truelnrush current surge with load	■	■	■	■	■	■	■	■	■	■
Min.	■	■	■	■	■	■	■	■	■	■
Max.	■	■	■	■	■	■	■	■	■	■
Peak			■			■	■		■	■
ΔX differential measurement		■	■		■	■		■	■	
ΔX/X relative measurement		■	■		■	■		■	■	
Input adapter (external sensor)		■			■			■		
Data-logging							■			■
PC interface / Bluetooth interface							■			■
CAT IV 600 V	■	■	■							
CAT IV 1000 V				■	■	■	■	■	■	■

F201 - F203 - F205

REF. : PO1120921 REF. : PO1120923 REF. : PO1120925

 600 AAC
900 ADC

TRMS

 1000 V
CAT III

 600 V
CAT IV

 True
InRush

 IEC
61010-2-032

★ STRENGTHS

- 34 mm clamping diameter
- Compact format
- TRMS AC+DC with the F205 clamp

⚙️ SPECIFICATIONS

	F201	F203	F205
Clamping diameter		Ø 34 mm	
Display	LCD	Backlit LCD	
Resolution		6,000 counts	
Number of values displayed		1	
Type of acquisition	TRMS AC	TRMS AC/DC	TRMS AC, DC, AC+DC
Autorange		Yes	
Automatic AC/DC detection		Yes	
AAC		600 A	
ADC		900 A	
AAC+DC		600 A (900 A peak)	
Best accuracy		1 % of reading+ 3 counts	
VAC		1000 V	
VDC		1000 V	
VAC+DC		1000 V (1400 V peak)	
Best accuracy		1 % of reading+ 3 counts	
Frequency for V / I		Yes / Yes	
Resistance		60 kΩ	
Audible continuity		Adjustable from 1 Ω to 599 Ω	
Diode test (semi-conductor junction)		Yes	
Temperature (type K)	°C: -60.0 to +1,000 °C °F: -76 to +1,832 °F		
Adapter		Yes	
Single phase and total three-phase power values			AC, DC, AC+DC
Active (W)			Yes
Reactive (var)			Yes
Apparent (VA)			Yes
PF			Yes
Harmonic analysis THDf / THDr			Yes / Yes
Phase rotation (2-wire method)			Yes
Functions			
Overcurrent measurement		Yes	
Motor InRush		Yes	
Evolution of load (TrueInrush)		Yes	
Hold		Yes	
Min / MAX		Yes	
Peak+ / Peak-			Yes
RELative ΔX		Yes	Yes
Differential ΔX/(%)		Yes	Yes
Auto Power Off		Yes	
Electrical safety as per IEC 61010-1, IEC 61010-2-032		600 V CAT IV - 1000 V CAT III	
Power supply		1 x 9 V 6LR61	
Dimensions / weight		78 x 222 x 42 mm / 340 g	



📦 CONTENTS

F201 delivered with:

- 1 set of built-in PVC test-probe leads (black/red) / insulated elbowed male banana plug Ø 4 mm
- 1 x 9 V 6LR61 battery
- 1 Multifix bag
- 1 mini-CD containing the User's Manual

F203 same as **F201** plus 1 wire thermocouple with built-in insulated Ø 4 mm banana connections with 19 mm spacing

F205 delivered with:

- 1 set of PVC leads (black/red) with insulated elbowed male banana plug Ø 4 mm / insulated straight male banana plug Ø 4 mm
- 2 test probes / insulated female plug Ø 4 mm (black/red)
- 1 safety crocodile clip (black)
- 1 x 9 V 6LR61 battery
- 1 Multifix shoulder bag
- 1 mini-CD containing the User's Manual

★ ACCESSORIES / REPLACEMENT PARTS

See all the accessories on page 32

F401 - F403 - F405 - F603 - F605

REF. : P01120941 REF. : P01120943 REF. : P01120945 REF. : P01120963 REF. : P01120965

 1000 Aac
1500 Adc

 2000 Aac
3000 Adc

TRMS

 1000 V
CAT IV

 IP
54

 True
InRush

 IEC
61010-2-032

★ STRENGTHS

F40X Series

- Low and medium-power LV applications
- 48 mm clamping diameter

F60X Series

- High-power LV applications
- 60 mm clamping diameter

⚙️ SPECIFICATIONS

	F401	F403	F405	F603	F605
Clamping diameter	Ø 48 mm		Ø 60 mm		
Display	Backlit LCD				
Resolution	10,000 counts				
Type of acquisition	TRMS AC	TRMS AC/DC	TRMS AC, DC, AC+DC	TRMS AC/DC	TRMS AC, DC, AC+DC
Autorange	Yes				
Automatic AC/DC detection	Yes				
Aac	1,000 A		2,000 A		
Adc	1,500 A		3,000 A		
Aac+dc			1,000 A (1,500 A peak)	2,000 A (3,000 A peak)	
Best accuracy	1 % of reading + 3 counts				
Vac	1,000 V				
Vdc	1,000 V				
Vac+dc			1,000 V (1,400 V peak)	1,000 V (1,400 V peak)	
Best accuracy	1 % of reading + 3 counts				
Frequency for V / I	Yes / Yes				
Resistance	100 kΩ				
Audible continuity	Adjustable from 1 Ω to 999 Ω				
Diode test (semi-conductor junction)	Yes				
Temperature (type K)	°C: -60.0 to +1,000 °C °F: -76 to +1,832 °F		°C: -60.0 to +1,000 °C °F: -76 to +1,832 °F		
Adapter	Yes		Yes		
Single-phase and total three-phase power values			Yes	Yes	
Active (W)			Yes	Yes	
Reactive (VAR)			Yes	Yes	
Apparent (VA)			Yes	Yes	
PF / DPF			Yes / -	Yes / -	
Harmonic analyses THDf / THDr			Yes / Yes	Yes / Yes	
Phase rotation (2-wire method)			Yes	Yes	
Functions					
Overcurrent measurement	Yes				
Motor Inrush	Yes				
Evolution of load (Truelnrush)	Yes				
Hold	Yes				
Min / MAX	Yes				
Peak+ / Peak-	Yes				
RELative ΔX	Yes				
Differential ΔX/X(%)	Yes	Yes	Yes	Yes	Yes
Auto Power Off	Yes				
Electrical safety as per IEC 61010-1, IEC 61010-2-032	1000 V CAT IV - 1000 V CAT III				
Power supply	4 x 1.5 V LR06				
Dimensions / weight	92 x 272 x 41 mm 600 g		111 x 296 x 41 mm 640 g		



⊕ ADDITIONAL INFO

- See also the F407 & F607 with harmonic measurement, recording and wireless connection.

📁 CONTENTS

F401 / F403 / F603 delivered with:

- 1 set of PVC leads (black/red) with insulated elbowed male banana plug Ø 4 mm / insulated straight male banana plug Ø 4 mm
- 2 test probes / insulated female plug Ø 4 mm (black/red)
- 1 wire thermocouple with built-in insulated Ø 4 mm banana connections with 19 mm spacing
- 4 x 1.5 V LR03 batteries
- 1 Multifix shoulder bag
- 1 mini-CD containing the User Manual

F405 / F605 :

- Same as F401 / F403 / F603 but without the wire thermocouple and with 1 black safety crocodile clip

🔧 ACCESSORIES / REPLACEMENT PARTS

See all the accessories on page 32

ACCESSORIES / REPLACEMENT PARTS

TESTERS

CA 732

- 1.5 V LR03 battery.....P01296032

CA 745N

- Set of red/black CAT III/IV test probes.....P01102152Z
- Set of red/black test probes
 - Ø 2 mm, CAT II.....P01102153Z
- Set of red/black test probes - Ø 4 mm, CAT II.....P01102154Z
- CA 753 universal measurement adapter for 2P+E sockets.....P01191748Z
- Velcro strap x 5.....P01102113
- 1.5 V LR03 alkaline battery.....P01296032
- Bag compatible with MultiFix accessory, 120 x 200 x 60 mm.....P01298074
- MultiFix mounting accessory.....P01102100Z

CA 755, CA 757

- Set of black/red CAT III/IV test probes.....P01102152Z
- Set of black/red Ø 2 mm test probes, CAT II.....P01102153Z
- Set of black/red Ø 4 mm test probes, CAT II.....P01102154Z
- MA101-250 current sensor for CA 757.....P01120591
- CA 753 universal measurement adapter for 2P+E sockets.....P01191748Z
- Velcro strap x 5.....P01102113
- 1.5 V LR03 alkaline battery.....P01296032
- Bag compatible with MultiFix accessory, 120 x 200 x 60 mm.....P01298074
- MultiFix mounting accessory.....P01102100Z

VOLTAGE DETECTORS

CA 742, CA 742 IP2X, CA 762 and CA 762 IP2X

- Measurement adapter for 2P+E socket, model CA 751 P01101997Z
- Universal measurement adapter for 2P+E socket, model CA 753 P01191748Z
- Red test probe Ø2 mm P01102008Z
- Black test-probe lead Ø2 mm P01102009Z
- Adapter for safety rod (set of 2) P01102034
- Crystal safety cap for test probe Ø2 mm (x10) P01102033
- Set of 2 leads 0.25 m and 0.85 m long with Ø4 mm IP2X test probes P01295285Z
- Set of 2 leads 1.5 m long with Ø4 mm IP2X test probes P01295462Z
- MultiFix shoulder bag, 120 x 200 x 60 mm P01298074
- IP2X CAT IV test probes P01102127Z
- IP2X Ø4 mm test probes P01102128Z
- Soft case, 200 x 100 x 40 mm with belt clip P01298065Z
- Shoulder bag no. 10 P01298012
- Wrist-strap P03100824
- 1 probe-holder cable 1.10 m long + 2 red/black ø 4 mm IP2X test probes P01102121Z

CA 771, CA 771 IP2X, CA 773 and CA 773 IP2X

- CAT IV test probes P01102123Z
- Ø2 mm test probes P01102124Z
- Ø4 mm test probes P01102125Z
- Test-probe protector P01102126Z
- IP2X CAT IV test probes P01102127Z
- IP2X Ø4 mm test probes P01102128Z
- CA 753 universal measurement adapter for European 2P+E power socket P01191748Z
- MultiFix shoulder bag, 120x320x60 mm P01298076
- Crystal safety cap for test probe Ø2 mm (x10) P01102033

ANALOGUE MULTIMETERS

CA 5001, CA 5003 and CA 5005

- Accessories kit for electricians P01295459Z
- CMI214S current measurement lead P03295509
- Shoulder bag P01298033
- Soft case no. 5 P01298036
- Hard case P01298037
- Shoulder bag no. 21 with strap (250x165x60 mm).....P06239502

CA 5001

- 1.5 V LR06 battery.....P01296033
- 0.5 A HRC fuse (x 10) P01297028
- 5 A HRC fuse (x 10) P01297035

CA 5003

- 9 V 6LR61 battery P01100620
- MN11 LCA 200/0.2 clamp.....P01120404
- 1.6 A HRC fuse (x 10).....P01297036
- 16 A HRC fuse (x 10).....P01297037

CA 5005

- 9 V 6LR61 battery P01100620
- MINI 09 clamp - 1 A / 100 MVDC.....P01105109Z
- MN11 LCA 200/0.2 clamp.....P01120404
- 10 A HRC fuse (x 10).....P01297038
- 1 A HRC fuse (x 10) P01297039

CA 5011

- 9 V 6LR61 battery P01100620
- Crocodile wire grip (x 2) P01102053Z
- Insulation-piercing clip (x 2) P01102055Z
- Moulded PVC lead with straight male plug/insulated elbowed male plug Ø4 mm (x 2) P01295451Z
- Moulded red/black silicone lead with straight male plug/insulated elbowed male plug Ø4 mm (x 2).....P01295453Z
- Safety test probe (x 2).....P01295454Z
- PVC test-probe lead, insulated elbowed male plug Ø 4 mm (x 2).....P01295456Z
- Crocodile clip (x 2) P01295457Z
- Ø 4 mm CAT II 300 V test probe (x 2) P01295458Z
- Ø 2 mm CAT II 300 V test probe (x 2) P01295460Z
- IP2X test-probe lead (x 2) P01295461Z
- Accessories kit for electricians P01295459Z
- CMI214S current measurement lead P03295509

DIGITAL MULTIMETERS

CA 5231, CA 5233, CA 5273, CA 5275 and CA 5277

- 9 V 6LR61 battery P01100620
- Crocodile wire grips (x 2).....P01102053Z
- Insulation-piercing clip (x 2) P01102055Z
- 40 kVdc / 28 kVac high-voltage probe.....P01102097
- MultiFix multi-position mounting accessory .. P01102100Z
- Moulded PVC lead with straight male plug/insulated elbowed male plug Ø4 mm (x 2).....P01295451Z
- Moulded red/black silicone lead with straight male plug/insulated elbowed male plug Ø4 mm (x 2) P01295453Z
- Safety test probe (x 2).....P01295454Z
- PVC test-probe lead, insulated elbowed male plug (x 2) P01295456Z
- Crocodile clip (x 2) P01295457Z
- Ø 4 mm CAT II 300 V test probe (x 2) P01295458Z
- Ø 2 mm CAT II 300 V test probe (x 2) P01295460Z
- IP2X test-probe lead (x 2) P01295461Z
- Accessories kit for electricians P01295459Z

CA 5231

- 100 AAC MINI 03 current clamp.....P01105103Z
- PAC 15 400 AAC / 600 ADC current clamp....P01120115

CA 5233, CA 5273 and CA 5277

- Safety thermocouple adapter (x 2).....P01102106Z
- Safety adapter and temperature probe, wire K sensor, -50°C to +450°C P01102107Z
- CMI214S current measurement lead P03295509

CA 5292 and CA 5293

- Calibration software HX0059B
- Pt100 adapter.....HX0091
- Kit of 4 NiMH batteries HX0051B
- External charger HX0053B
- USB optical cable.....HX0056Z
- Safety adapter and -50°C to +450°C and wire K-sensor temperature probe P01102107Z
- Kit with PWM filter + E27 clamp.....P01102188

CA 922 and CA 942

- Kit with PWM filter + E27 clamp.....P01102188
- Power supply kit with USB/JACK cable and USB charger.....P01103080
- Calibration software HX0099
- PC acquisition software.....SX-METRO /P

CLAMP MULTIMETERS

F200, F400 and F600 SERIES

- MultiFix multi-position mounting accessory .. P01102100Z
- Moulded PVC lead with straight male plug/insulated elbowed male plug Ø4 mm (x 2).....P01295451Z
- Moulded red/black silicone lead with straight male plug/insulated elbowed male plug Ø4 mm (x 2) P01295453Z
- Safety test probe (x 2).....P01295454Z
- PVC test-probe lead, insulated straight male plug Ø 4 mm (x 2) P01295455Z
- PVC test-probe lead, insulated elbowed male plug Ø 4 mm (x 2) P01295456Z
- Crocodile clip (x 2) P01295457Z
- Ø 4 mm CAT II 300 V test probe (x 2) P01295458Z
- IP2X test-probe lead (x 2) P01295461Z
- Accessories kit for electricians P01295459Z
- CMI214S current measurement lead P03295509

F400 and F600 SERIES

- 1.5 V LR06 battery.....P01296033
- MultiFix shoulder bag 120x320x60 mm P01298076

F201 and F205

- 9 V 6LR61 battery P01100620
- MultiFix shoulder bag 120x245x60 mm.....P01298075

F203

- 9 V 6LR61 battery P01100620
- Safety thermocouple adapter (x 2).....P01102106Z
- Safety adapter and temperature probe, wire K sensor, -50°C to +450°C P01102107Z
- MultiFix shoulder bag 120x245x60 mm.....P01298075

F403 and F603

- Safety thermocouple adapter (x 2).....P01102106Z
- Safety adapter and temperature probe, wire K sensor, -50°C to +450°C.....P01102107Z

MA400D & MA400D

- Shoulder bag 120x200x60 mm.....P01298074
- MultiFix accessories.....P01102100Z
- Velcro strap (set of 5).....P01102113

See all our accessories
on page 150

NOTES

INFO AND ADVICE	34
INSTALLATION TESTERS	39
INSULATION TESTERS	45
CLAMP MULTIMETERS FOR LEAKAGE CURRENT	55

EARTH AND RESISTIVITY TESTERS	56
ELECTRICAL EQUIPMENT TESTERS	63
OTHER TESTERS	68
DATA PROCESSING SOFTWARE	74
ACCESSORIES	81

ELECTRICAL INSTALLATION TESTING

The risks linked to incorrect use of electricity may include:

- life-threatening danger for people,
- threat of damage to electrical installations and property,
- harmful effects on systems operation and equipment life spans.

So the purpose of electrical installation testing is primarily to ensure that people and goods are kept safe and are protected in the event of a fault. It also facilitates preventive maintenance of installations, preventing serious faults which might prove expensive (production shutdown, etc.).

To guarantee people's safety with regard to these installations and the electrical equipment connected to them, standards have naturally been developed and updated to take changes into account. The IEC 60364 standard and its various national equivalents published in each European country, such as NF C 15-100 in France or VDE 100 in Germany, specify the requirements concerning electrical installations in buildings. Chapter 6 of this standard describes the requirements for testing the compliance of an installation.

The effectiveness of the safety measures implemented can only be guaranteed if regular tests prove they are operating correctly. This is why the standards cover not only the initial verifications when installations are commissioned, but also periodic testing whose frequency depends on the type of installation and equipment, its use and the legislation in the country involved. In addition, the tests must be carried out with measurement instruments that comply with the IEC 61-557 European standard ensuring user safety and reliable measurements.

The electrical testing is divided into 2 parts:

1. Visual inspection to guarantee that the installation complies with the safety requirements (presence of an earth electrode, protective devices, etc.) and does not show any visible evidence of damage.
 2. Measurements
- There are 4 main measurements required:
1. Earth
 2. Continuity
 3. Insulation
 4. Tests of protective devices

1. EARTH

To guarantee safety on residential or industrial electrical installations, one of the basic rules is that there must be an earth electrode.

If there is no earth electrode, it may endanger people's lives and damage electrical installations and property. When a large enough area is available to set up stakes, you should measure the earth with the traditional 3-pole method, also known as the 62 % method.

When the 62 % method is not applicable, however, other methods can be used. There are many methods for measuring the earth (1P live earth, PH-PE loop impedance, selective earth with 1-clamp method, etc.), some more suitable than others, depending on the type of earth connection system, the type of installation (residential, industrial, urban, rural, etc.), the possibility of cutting off the power, the area available for planting stakes, etc.

2. CONTINUITY

The purpose of continuity measurement is to check the continuity of the protective conductors and the main and supplementary equipotential bonds. The test is carried out using a measuring instrument capable of generating a no-load voltage of 4 to 24 V (DC or AC) with a minimal current of 200 mA. The resistance measured must be lower than a threshold specified by the standard applicable to the installation tested, which is usually 2 Ω. As the resistance value is low, the resistance of the measurement leads must be compensated, particularly if very long leads are used.

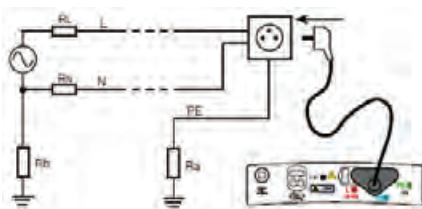

Example : Approximate measurement of earth resistance by the Zs (Ph-PE) loop measurement method in a TT-type earthing system

3. INSULATION

Good insulation is essential to prevent electric shocks. This measurement, usually carried out between active conductors and the earth, involves injecting a DC voltage, measuring the current and thus determining the insulation resistance value.

The power must be switched off and the installation must be disconnected before performing this test to ensure that the test voltage will not be applied to other equipment electrically connected to the circuit to be tested, particularly devices sensitive to voltage surges. According to the IEC 60364 standard, the minimum insulation resistance values must be as follows:

Rated voltage of circuit V	DC test voltage V	Insulation resistance MΩ
SELV or PELV	250	≥ 0.5
≤ 500 V including PELV	500	≥ 1.0
> 500 V	1000	≥ 1.0

4. TESTS OF PROTECTIVE DEVICES

Fuses / Circuit-breakers

To check the specifications of the protective devices such as fuses or circuit-breakers, a fault loop impedance measurement is carried out to calculate the corresponding short-circuit current. A visual inspection can then be used to check that the sizing is correct. A fuse table directly integrated in certain installation testers can be used to check automatically that the fuses are correctly sized.

Residual Current Devices (RCDs): types AC, A and B

RCDs, which detect earth leakage currents, can be tested using two methods:

- the basic test, also called a pulse test, which determines the trip time (in milliseconds)
- the step test, which determines the trip time and trip current, thus detecting any RCD ageing.

Type-B RCDs are designed to provide a specified response for DC-only leakage currents. A specific test is then required to check RCDs of this type.

5. OTHER RECOMMENDED MEASUREMENTS

When testing low-voltage installations, other measurements are recommended (mandatory in some countries) such as:

- The voltage drop ΔV% in the cables, obtained by means of two line-impedance measurements to check that their cross-sections are appropriate
- The correct phase order in three-phase systems, thus ensuring that rotating machines turn in the right direction
- The installation's voltage and frequency, allowing identification of any poor connections

Detection of phase current unbalance by measuring with a clamp and first-level assessment of the harmonic content are useful additions to any installation analysis.

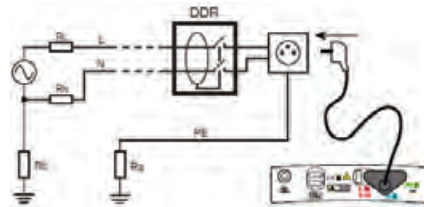

Example : RCD test via connection in a wall socket in TT-type earthing systems..

INSULATION MEASUREMENT

To ensure that electrical equipment and installation operate correctly in total safety, all the conductors are insulated: sheathing for cables, varnish for windings. When the quality of these insulating materials diminishes, leakage currents may flow from one conductor to the other and, depending on the extent of the insulation faults (the worst being a short-circuit), may cause serious damage.

Equipment with faulty insulation may break down, burn or cause a fault on the installation itself, thus triggering protective devices and shutting down the whole installation...

Furthermore, some particularly sensitive installations (operating theatres in hospitals, chemical industries, etc.) are built using an IT-type earthing system (cf. IEC 60364-6), which tolerates an initial line-earth insulation fault and only shuts down the installation if a second fault occurs.

Measurements are needed to prevent and prepare for the hazards linked to insufficient or damaged insulation. These measurements concern both the electrical equipment and the installations to which it is connected. **These measurements are carried out during commissioning** on new or reconditioned items, and then **repeated regularly** to monitor their evolution over time.

INSULATION RESISTANCE MEASUREMENT AND DIELECTRIC TESTING

These two concepts, which characterize the quality of an insulant, require further explanation as they are too frequently confused.

■ **Dielectric strength testing**, also called "breakdown testing", **measures an insulant's ability to withstand a medium-duration voltage surge without sparkover occurring.** In reality, this voltage surge may be due to lightning or the induction caused by a fault on a power transmission line. The main purpose of this test is to ensure that the construction rules concerning leakage paths and clearances have been respected. This test is often performed by applying an AC voltage but can also be done with a DC voltage. This type of measurement requires a dielectrometer.

The result obtained is a voltage value usually expressed in kilovolts (kV). Dielectric testing may be destructive in the event of a fault, depending on the test levels and the available energy in the instrument.

For this reason, it is reserved for type tests on new or reconditioned equipment: only equipment that passes the test will be put into service.

■ **Insulation resistance measurement**, however, is non-destructive under normal test conditions. Carried out by applying a DC voltage with a smaller amplitude than for dielectric testing, it yields a **result expressed in kΩ, MΩ or GΩ.** This resistance indicates the **quality of the insulation between two conductors** and provides a good idea of the risks of leakage currents. Because it is non-destructive, it is particularly useful for monitoring insulant ageing during the operating life of electrical equipment or installations. This means it can be used as a basis for preventive maintenance. This measurement is performed using an insulation tester, also called a megohmmeter.

MEASURING LEVELS OF INSULATION

In concrete terms, first of all the installation or equipment is checked to ensure that no voltage is present in it. Then a DC test voltage is applied and the insulation resistance value is read. **When measuring an insulation in relation to the earth, you are advised to place the positive pole of the test voltage on the earth** to prevent earth polarization problems when carrying out multiple tests.

All the standards concerning electrical installations or equipment specify the measurement conditions and minimum thresholds to be respected for insulation measurements.

INSULATION MEASUREMENT APPLICATIONS

Insulation measurement on electrical installations

Insulation test before powering up

Before powering up a new installation, its insulation must be tested.

Two types of measurements are required:

- **Verification of the conductors: this checks that none of the conductors**, cut-off devices or connection equipment has suffered damage liable to cause an insulation fault. This is done before commissioning the installation, with all the receivers disconnected..
- **Verification of the whole installation** in relation to the earth.

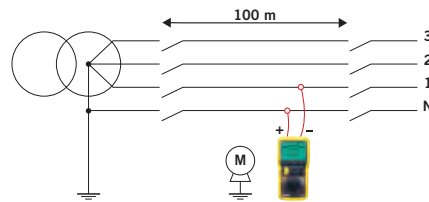

Insulation test after powering up

After powering up the installation, **the insulation should be checked regularly** to make sure there is no substantial drift away from the initial values.

Because the method used is the same as for testing before powering up, the installations must be switched off.

In both cases, the insulation will be considered acceptable if the insulation resistance measured is greater than the threshold specified by the applicable standard for the installation tested (NF C 15-100 in France, VDE 100 in Germany, European standard IEC 60364, IEEE 43-2000, etc.)

Insulation measurement on motors, transformers, etc.

Whether on electrical installations or on machines, **the quality of the insulating materials deteriorates as time passes** due to the stresses affecting the equipment. This deterioration reduces the electrical resistivity of the insulants, leading in turn to an increase in the leakage currents and causing incidents which may be serious in terms of the safety of people and property, but also in terms of production stoppage costs in industry.

So, in addition to the measurements during commissioning of new or renovated equipment, **regular insulation testing of installations and equipment helps to prevent such incidents by organizing preventive maintenance** designed to detect ageing and therefore prevent premature deterioration of the insulation properties before they reach a level liable to cause the incidents described above.

Deterioration of the equipment may occur naturally, but it is often also accelerated by external contaminants such as dust, oil, etc. It is therefore strongly recommended to monitor its insulation over time.

To carry out this preventive maintenance effectively, the **Chauvin Arnoux range of megohmmeters** proposes the following functions:

- PI, DAR and DD quality ratios for a quick assessment of insulation quality, with the added advantage that they are not particularly influenced by temperature, making them easy to use without requiring correction of the results
- Automatic calculation of the insulation resistance at a reference temperature (CA 6549, CA 6550, CA 6555)
- Method based on the influence of test voltage variation (step voltage measurement)

CRITERIA FOR CHOOSING AN INSULATION TESTER

Here are a few tips to help you choose an insulation tester that matches your requirements.

■ The application.

What type of equipment will you be testing: electrical installations, switchgear, telephony, etc.
Rated operating voltage, manufacturer recommendations, dedicated standards
Test voltage: 50 – 100 – 250 – 500 – 1,000 – 2,500 – 5,000 – 10,000 – 15,000 V_{DC}
Measurement range: kΩ, MΩ, GΩ, TΩ

■ User comfort.

Reading mode: needle display with logarithmic scale, digital LCD, analogue bargraph
User-friendly features: programmable alarm thresholds, backlighting, remote control probe

■ Operating mode.

Hand-cranked generator, normal or rechargeable batteries
Other measurements required: continuity, current, voltage, etc.
Single-function or multi-function instrument, for testing installations or machines

EARTH MEASUREMENT

For residential or industrial installations, the presence of an earth connection is one of the basic rules to ensure that the electrical installation is safe.

The absence of an earth connection may endanger people's lives and damage electrical installations and property.

However, the presence of an earth connection does not guarantee safety and, even if the earth is correctly sized, only regular testing can ensure that it functions correctly. The standards for electrical installations, such as IEC 60364, NF C 15-100, etc., stipulate the general installation conditions to be applied in order to guarantee the safety of people, pets, farm animals and property by protecting them against the hazards and damage which may result from use of the electrical installations.

When there is a large enough area available to set up stakes, earth measurement should be carried out with the traditional 3-pole method, also known as the 62 % method.

There are a large number of different methods for earth measurements, however, and the right choice depends on the type of earthing system, the type of installation (residential, industrial, urban, rural, etc.), the possibility of switching off the power supply, the area available for setting up stakes, etc.

LIST OF THE DIFFERENT EARTH MEASUREMENT METHODS

Here is an overview of the most frequently-used measurement methods:

The 62 % in-line measurement method (two stakes)

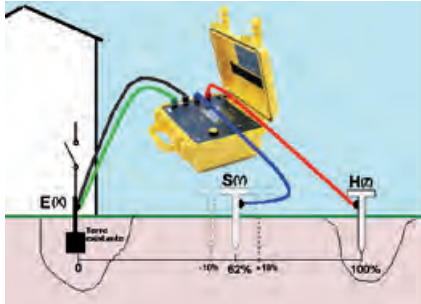

Existing earth

This method requires the use of two auxiliary electrodes (or "stakes") to allow current injection and provide the 0 V reference potential.

The positioning of the two auxiliary electrodes in relation to the earth connection to be tested E(X), is crucial. For correct measurements, the "auxiliary connection" providing the reference potential (S) must not be positioned in the areas influenced by earths E & H due to the flow of the current (i).

Statistics from the field have shown that the ideal method for guaranteeing the highest possible measurement accuracy involves placing the stake S at a point 62 % of the distance from E on the line EH.

You must then make sure that the measurement does not vary significantly when moving the stake S by ± 10 % (S' and S'') on either side of its initial position, while remaining on the line EH.

If the measurement varies, it means that (S) is in an influence area, so the procedure should be repeated after increasing the distances.

For a correct measurement, the stake H should be at least 25 metres away from the earth to be tested.

For more accurate measurement, it is possible to use a 4-pole measurement method (adding a connection between the earth to be tested and the ES terminal of the measurement instruments) to minimize the resistance of the measurement leads, thus improving accuracy. This method is strongly recommended for low resistance values as the influence of measurement-lead resistance will then be considerable.

Line-PE loop measurement (only on TT system)

In urban environments, it often proves difficult to measure earth resistances using auxiliary stakes because it is not possible to set up the stakes for reasons of space, concreting, etc.

Loop measurement can then be used to test earths in urban environments without using stakes simply by hooking up to the mains power supply (mains socket). In addition to the earth to be measured, the loop resistance measured in this way includes the earth and internal resistance of the transformer and the resistance of the cables. As all these resistances are very low, the value measured is an overall earth resistance value.

The actual earth resistance is therefore lower: $R_{measured} > R_{earth}$. The (overall) measurement error introduced by this method actually contributes to greater safety. The standards concerning electrical installations consider that the loop resistance (overall earth resistance) may be taken into account instead of the earth resistance to comply with the rules on protection against the risk of indirect contacts.

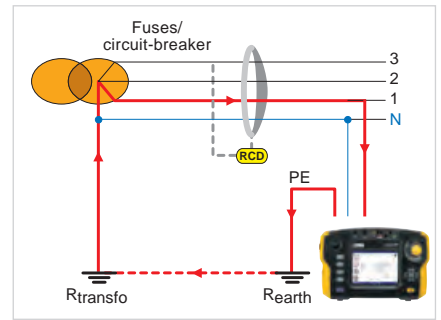

Note: on TN or IT (impedant) systems, the loop impedance measurement can be used to calculate the short-circuit current and thus to size the protective devices correctly.

Selective earth measurements

For interconnected earths, selective earth measurement can be used for quick, safe testing. In this case, it is not necessary to isolate the installation (no need to open the earth bar) and, for loop measurements with 2 clamps or with an earth clamp, it is not necessary to set up stakes. For the earth clamp and for the 2-clamp method, all you have to do to find out the earth value and the value of the currents flowing in it is clamp the cable connected to the earth.

An earth clamp comprises two windings: a generator winding and a receiver winding:

- The clamp's "generator" winding develops an AC voltage at the constant level E around the clamped conductor; a current $I = E / R_{loop}$ then flows through the resistive loop.
- The "receiver" winding measures this current.
- As E and I are known values, the loop resistance can be deduced from them.

This case involves a network of parallel earths. Knowing that "n" resistances in parallel are equivalent to a resistance R_{aux} with a negligible value, we can measure the local earth value R_x :

$$R_{loop} = R_x + R_{aux} \text{ (where } R_{aux} = \text{resistance equivalent to } R_1 \dots R_n \text{ in parallel)}$$

As $R_x \gg R_{aux}$, we obtain the result $R_{loop} \approx R_x$

The 2-clamp method is an equivalent method. One clamp acts as the generator, while the second acts as the receiver. This method may be more practical in places where access is difficult or when a larger clamping diameter is required.

Schematic diagram: earth clamp

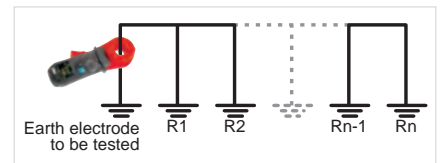

Schematic diagram: 2-clamp method

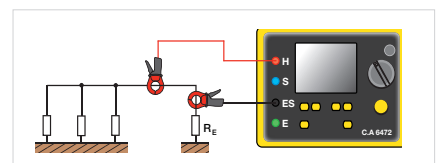

It is also possible to use the 4-pole + clamp method, which requires auxiliary stakes but allows precise measurement of the earth resistance.

	Rural building with possibility of setting up stakes	Urban building with no possibility of setting up stakes
Single earth connection		
3-pole method alias 62 % method	■	
Triangle method (2 stakes)	■	
4-pole method	■	
Variant 62 % method (1 stake)	■	
Line-PE loop measurement	■	Only with TT system
Network of multiple parallel earths		
Selective 4-pole method	■	
Earth clamp	■	■
Earth loop measurement with 2 clamps	■	■

SAFETY OF MACHINES, SWITCHBOARDS AND PORTABLE ELECTRICAL APPLIANCES

SAFETY OF MACHINES

The IEC 60204 / EN 60204 standard defines a machine as a set of parts or systems linked together, at least one of which is mobile. The fields of application are particularly diverse: machines for working metal, wood, textiles, printing, compressors, leather, tanneries, agricultural machinery, building sites and quarries, etc.

Part 1 of this reference standard defines the general requirements regarding electrical machine safety to ensure the protection of people who may be exposed to hazardous phenomena due to failure of the electrical equipment or the command circuits, disturbances in the power sources or power circuits, loss of continuity in the circuits, electromagnetic disturbances, release of accumulated energy, excessive audible noise or excessive surface temperatures.

To ensure electrical safety on the machines, you have to carry out a number of checks and tests after initial implementation, installation, renovation or modification and during periodic testing.

■ **Checking of the protective automatic cut-off systems on the power supply in particular (the types of tests and checks depend on the earthing system):**

- Checking of PE continuity on each circuit in the machine with a measurement current ≥ 200 mA which may be as high as 10 A,
- Verification of the loop impedance as per IEC 61557-3 and correct coordination of the protection against overcurrents
- Visual check of the protection against overcurrents
- RCD testing as per IEC 61557-6, tripping-time test (recommended)
- Verification of the current at the first insulation fault by measurement or calculation
Note: this test may be simplified depending on the condition of the machine as established by a questionnaire included in the standard.

■ **Insulation resistance measurement at 500 V_{DC}, R > 1 M Ω**

■ **Test of dielectric strength with 50 or 60 Hz AC voltage, at 2 x UN or 1,000 V, duration 1 sec (without disruptive discharge)**

■ **Residual overvoltage test by measuring the discharge time < 1 sec or 5 sec.**

■ **Operating test of the machine and the circuits involved in electrical safety**

The tests are usually performed in the order of decreasing failure in order to intercept electrical safety problems on the machine tested as quickly as possible. Other aspects of the machine may be checked, such as the conformity of the documentation, the temperature reached, the correct order of the phase sequence and the phase drop between the power supply and the load.

SWITCHBOARD SAFETY

A recent upgrade of this standard precisely defines the limits of liability between the original manufacturer, who should perform the design checks, and the assembler (switchboard operator) who should perform individual series testing. These checks include construction and performance tests. The switchboard operator is considered to become the original manufacturer if modifications are made to the low-voltage switchboard. A declaration of conformity based on simple comparison with a similar switchboard will not be accepted, so a new check is necessary. This new context means that additional test equipment is needed to ensure compliance with the requirements of this reference standard.

The tests required for low-voltage switchboards are:

■ **Physical measurement of the insulation gap or leakage distance**

■ **PE continuity check** with a measurement current ≥ 200 mA which may be up to 10 A ($R \leq 0.1 \Omega$)

■ **Short-circuit withstand** by creating a bolted short-circuit

■ **Checking of the dielectric properties** by a test at 50 / 60 Hz with the application of a voltage between the different groups of terminals rising slowly and then held for 5 sec or 1 sec

■ **Insulation test (variant)**

Other aspects can also be checked, such as the discharge time, the IP protection rating, the electrical circuits and connections (by random testing), identification of the external terminals, mechanical operation, shock voltage withstand, heating, etc.

SAFETY OF PORTABLE ELECTRICAL APPLIANCES

The VDE 701 and VDE 702 standards define the inspections to be performed after repair or modification of the electrical appliances and the periodic inspections necessary, as well as general guidelines for electrical safety. This reference standard describes the automatic sequencing of the tests to be performed. Many of the tests and checks to be performed are identical to those described in the Machines and Switchboards section, plus certain tests "with probes" when the equipment does not have double insulation or reinforced insulation (Class I).

Furthermore, the leakage current measurements must include leakage measurements by different methods (substitution method, differential leakage method, contact leakage method, etc.). The polarity of the mains leads must also be checked to ensure that it complies.

MAIN TESTS & CHECKS

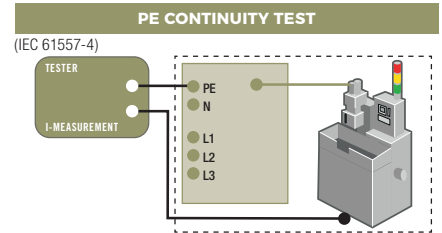

Used to check whether the resistance measured corresponds to the cross-section and length of the PE conductor.

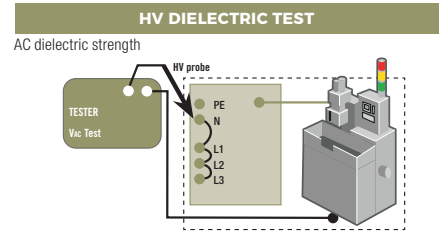

The AC dielectric test can be used to confirm the device's ability to function at its operating voltage. These tests are performed at a higher voltage than the normal operating voltage.

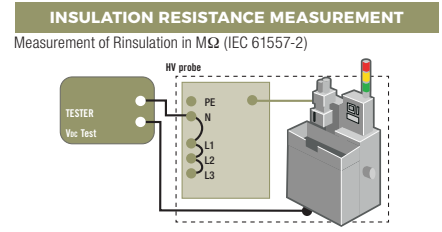

By measuring the insulation resistance, it is possible to detect faults due to deterioration or pollution and mould.

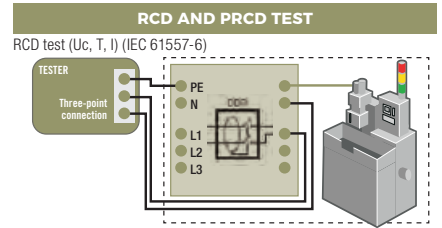

The RCD test can be used to check operation of the RCDs.

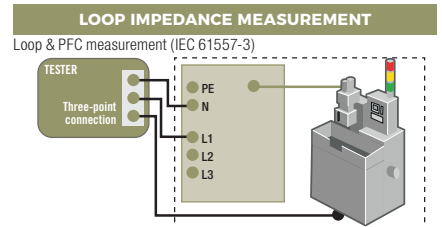

By measuring the loop impedance and calculating the prospective fault current (PFC), you can check that the automatic cut-off systems or fuses are appropriately sized.

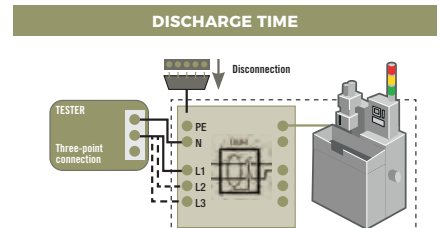

When the machines are disconnected, high-value capacitors may supply a hazardous voltage. This test measures whether the time taken by the discharge voltage to reach a non-hazardous value complies with the requirements (< 5s / < 1s).

TECHNICAL OVERVIEW / OTHER TESTERS

LOW RESISTANCE MEASUREMENT

The measurement of low resistances is **widely used in preventive maintenance** to check the continuity of the chassis-earths, surface condition and metallization, the quality of the contacts in the switches and relays, the resistance of the cables and windings, to assess motor and transformer heating and, in general, to check the mechanical joints. A wide variety of fields are involved, including the automotive sector, telecommunications, transport, motor and transformer manufacturers, etc. as well as the repair and maintenance companies working in these different sectors.

Measurement principle

The **basic principle** for measuring resistance involves **applying Ohm's Law**: $U = R \times I$.

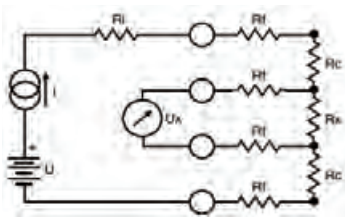

Where: R_i = internal resistance of the instrument,
 R_f = resistance of the measurement wires R_c = contact resistance
 R_x = resistance to be measured

When measuring very low resistances, a measurement current is injected and the resulting voltage is measured on the terminals of the resistance to be checked. The connections are the same as for 4-wire measurements, often called a Kelvin assembly, which limits the influence of the measurement leads when measuring low resistances.

The connection diagram is shown opposite:

From a DC voltage source U , a generator supplies a current with the value I .

A voltmeter measures the voltage drop U_x at the terminals of the resistor R_x to be measured and displays $R_x = U_x / I$. The result is independent of the other resistances encountered in the current loop (R_i , R_f , R_c), as long as the total voltage drop which they cause with R_x remains lower than the voltage which the current source can supply.

In practice, double retractable test probes, pivoting or otherwise, or Kelvin clamps are used for better contact with the object to be tested. Lastly, when measuring on a rivet, the two contacts of a given test probe must be capable of retracting by different amounts.



The micro-ohmmeters must offer a resolution of $1 \mu\Omega$ or even $0.1 \mu\Omega$, a wide measurement range and compensation of the thermocouple effects by inversion of the measurement current. To ensure operator safety, the equipment must be protected against accidental overvoltages, prevent measurement in the presence of a disturbance voltage and trigger automatic discharging after measurements on inductive objects.

Lastly, as the resistance of metals changes significantly according to the temperature, it is a good idea to present the result at a given reference temperature. The

instruments with the best performance automatically perform this calculation according to the type of metal, its temperature coefficient (approximately $0.4\% / ^\circ\text{C}$ for copper or aluminium), the ambient temperature and the reference temperature.

MEASUREMENT OF THE TRANSFORMER RATIO AND EXCITATION CURRENT

Strict compliance with the primary / secondary ratio values of the voltage, power and current transformer is crucial because any variation of these values over time is a sign of problems in the transformer, such as internal damage, possible deterioration of the insulants due to mechanical damage or contamination or short-circuits between loops. In addition, accurate measurement of the excitation current can identify problems in the magnetic core of the transformer, such as type and thickness of the material, mechanical stresses and air-gap and assembly variations.

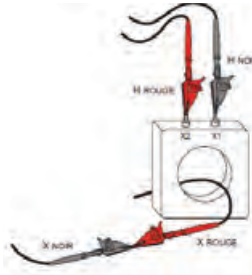

By checking the winding polarity and the presence of open circuits or groups of terminals in open circuit, it is possible to detect rewiring errors after maintenance operations.

Transformer ratio measurements performed using the method described in the IEEE C57.12-90™- 2006 reference document ensure standard, repeatable measurements. As such measurements are often performed in environments where a lot of noise is present, it is important for the operator to be able to choose different filters in order to obtain more reliable results in such environments.

Operator safety is ensured by a technique involving primary excitation, thus guaranteeing that no hazardous signal can occur at the secondary terminals of the transformer being tested. Storage of different "boilerplates" (specifications) in the instrument and direct display of the ratio value and its percentage deviation from the rated value help to speed up interpretation of the measurements performed. Their long battery life and their storage capacity for the results make digital ratiometers particularly useful for performing and analysing measurements.

MOTOR DIRECTION AND PHASE ROTATION TESTS

Interconnection of several sections of the electrical network or several buildings on the same site in a three-phase system requires the phase sequence to follow the normal direction. This is **particularly crucial for the power supplies of rotating machines as the rotation order of the phases connected determines the direction of the rotating field and therefore the rotation direction of the rotor.**

Phase rotation direction

The phase rotation direction can be determined by connecting the three phases of the electrical network to be tested to the tester, in accordance with the markings. **The tester then indicates the phase rotation direction:** clockwise or anticlockwise. In this case, the tester is self-powered via the measurement inputs.

To cover a wide range of applications, **the equipment must be capable of operating at frequencies from 15 to 400Hz.**

Rotating field direction or rotation direction without connection

For some phase sequence detectors, the possibility of testing without connection, simply by positioning the tester on the casing of the motor, allows you to obtain a quick indication of the rotating field direction. In this mode, the tester must be set up in parallel to the rotor and in the prescribed direction. This principle is not valid when controlling a motor by means of a frequency converter.

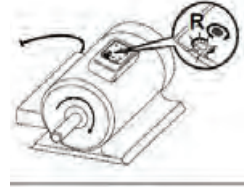

Determination of the phase connection direction on a motor

If you connect the motor's power supply phases to the tester and turn the rotor half a turn to the right by hand, the tester indicates whether or not the phase wires are connected in the right order.

Indication of solenoid valve activation without connection

On testers capable of testing without connection, the activation of a solenoid valve can be detected by placing the tester close to the valve. The clockwise or anticlockwise LED then indicates the direction of the field generated.

BATTERY CAPACITY MEASUREMENT

Research carried out by battery manufacturers has shown that **the internal impedance of a rechargeable battery increases with its age and the number of discharges which it has undergone.** By analysing the internal impedance, you can therefore assess the condition of the elements inside and determine whether the battery needs to be replaced or not.

Instead of the absolute value of the battery's internal resistance, it is the variation of the value which is important. Indeed, a 25% increase causes performance to fall by approximately 80%. These values may vary according to the battery technology involved. These values are compared with the instantaneous measurements made and noted when the batteries were installed.

Preventive maintenance equipment should simultaneously measure and display the internal resistance by means of a 4-wire method for AC at a frequency close to 1 kHz, **as well as the open-circuit voltage.** As the internal resistance values measured may be low, you have to compensate the resistance of the measurement leads and retractable test probes. A large number of alarm comparison systems are used to quickly detect battery deterioration. On the basis of this comparison, the result is assessed and one of the LEDs (PASS, WARNING, FAIL) is then activated accordingly.

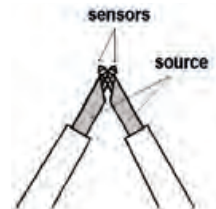

CHOOSE YOUR INSTALLATION TESTER



	CA 6113 page 40	CA 6116N page 40	CA 6117 page 40	CA 6011 page 43	CA 6131 page 42	CA 6133 page 42
Insulation						
Test voltage		50 / 100 / 250 / 1,000 V			250 / 500 V	250 / 500 / 1,000 V
RCD tests						
No-Trip tests	■	■	■		■	■
Trip time (pulse)	■	■	■		■	■
Trip current (Ramp)	■	■	■		■	■
Management of standard or selective RCDs, type AC or A	■	■	■		■ (standard)	■ (standard)
Management of type-B RCDs			■			
Earth measurement						
2P / 3P earth	■	■	■			■
1P live earth (RA)	■	■	■			
Selective earth with 1 clamp (RA Sel)	■	■	■			
Loop impedance & resistance						
Z-loop (L-PE)	■	■	■		■	■
Z-Line (L-N or LL)	■	■	■		■	■
Ik calculation (PFC)	■	■	■		■	■
Icc calculation (PSCC)	■	■	■		■	■
Integrated fuse table			■			
Voltage drop			■			
Resistance / Continuity						
Manual & automatic measurements	■	■	■	■	■	■
Other functions						
Voltage / frequency	■	■	■		■ / -	■ / ■
Current / leakage current on clamp	■	■	■		■	■
Phase sequence	■	■	■		■	■
Power values		■	■			
Harmonics		■	■			
Wiring polarity test + reversal	■	■	■			
Alarms	■	■	■		■	■
Data Storage / Communication						
Data storage		■	■			■
Storage of 3 tree-structure levels		■	■			
USB interface		■	■			
Bluetooth						■
Display and power supply						
Black and white LCD				■ (Two-colour backlighting)	■ (Custom)	■ (Custom)
Black and white graphical LCD	■					
Colour graphical LCD		■	■			
Online help	■	■	■			
Battery operation				■	■	
Operation with rechargeable batteries	■ Ni-Mh	■ Li-ion	■ Li-ion			■ Ni-Mh
Software						
ICT / DataView®		■	■			
Android application						■
Safety / Standards						
IEC 61010-1 600 V CAT III	■	■	■		■	■
IEC 61557	■	■	■	■	■	■

CA 6113 - CA 6116N - CA 6117

REF.: P01145445

REF.: P01145455

REF.: P01145460

600 V
CAT IIIIP
53

★ STRENGTHS

- Tests on RCDs (types AC, A and B)
- Battery life of up to 30 hours
- Testing according to IEC 60364-6, NF C 15-100, VDE 100, FD C 16-600...
- Automatic continuity measurement
- Colour screen (except CA 6113)
- Measurements: voltage, current via clamp, power, waveforms and harmonics
- Loop measurement with 1 mΩ resolution



★ ACCESSORIES / REPLACEMENT PARTS

Three-point lead with separated wires 2.5 m	P01295398
Three-point lead for testing European mains sockets	P01295393
See all the accessories on page 81	

📦 CONTENTS

CA 6113 delivered in a shoulder bag with:

- 1 x PA 30 W power pack
- 1 Euro 3-point lead - 3 safety leads (red, blue, green)
- 3 test probes Ø 4 mm (red, blue, green)
- 3 crocodile clips (red, blue, green)
- 2 elbowed-straight safety leads (red and black) 3 m long
- 1 three-point Euro mains lead
- 1 remote-control probe
- 1 anti-scratch film mounted on the instrument
- 1 wrist-strap
- 1 x 4-point hands-free strap
- 1 CD-ROM containing the user's manual

CA 6116N and **CA 6117** delivered in a shoulder bag with:

- 1 mains power / charger pack (type 2)
- 1 Li-Ion rechargeable battery pack mounted on the instrument
- 1 USB A / B cable 1.80 m long with ferrite
- 1 three-point lead - 3 safety leads (red, green and blue)
- 3 test probes Ø 4 mm (red, green and blue)
- 3 crocodile clips (red, green and blue)
- 2 elbowed-straight safety leads 3 m long (red and black)
- 1 three-point EURO mains lead
- 1 two-point EURO mains lead
- 1 remote-control probe
- 1 anti-scratch film mounted on the instrument
- 1 wrist-strap
- 1 x 4-point hands-free strap
- ICT data export software on CD-ROM
- 1 CD-ROM containing the user manual



+ ADDITIONAL INFO

- Integrated fuse table for quick result readings on the instrument
- User-friendly interface
- Extra-wide graphical screen
- Integrated contextual help for each function
- ICT data export software provided
- Compatible with the DataView® software
- Delivered as standard with a three-point European mains lead

EFFECTIVE CONTEXTUAL HELP AND GUARANTEED SAFETY

These testers are equipped with clear, detailed contextual help. This makes them suitable for both experts and less-experienced users. There is dedicated help for each measurement, including a guide to the connections to be set up and help for interpreting the results. For greater safety, if it is incorrectly connected or if a hazardous voltage is present, the instrument displays an error message in order to warn the user.



		CA 6113	CA 6116N	CA 6117
Continuity / Resistance				
	Measurement current	I > 200 mA up to 39.99 Ω and approx. 12 mA up to 400 Ω		
	Accuracy	± (1.5% of measurement + 2 cts), with audible beep		
	Range	4 kΩ / 40 kΩ - 400 kΩ		
Insulation				
	Test voltage	50 / 100 / 250 / 500 / 1,000 V _{DC}		
	Range / accuracy	0.01 MΩ to 2 GΩ / ±(5 % of measurement + 3 cts)		
	Short-circuit current	≤ 3 mA		
Earth				
3P earth	Range	0.50 Ω to 15 kΩ		
	Accuracy	±(2 % of measurement + 2 cts)		
	Others	RH & RS auxiliary-stake resistance measurement (up to 40 kΩ)		
Selective 1P earth	Range / accuracy	0.20 Ω to 399.9 Ω ±(10 % of measurement + 10 cts) (ISel via clamp)		
Loop impedance (Zs (L-PE) and Zi (L-N or L-L)) – 1P live earth				
Live earth	Installation voltage / freq.	90 to 500 V / 15.8 to 17.5 Hz - 45 to 65 Hz		
	High current mode - Zs (L-PE) (TRIP) & Zi (L-N or L-L) Range / accuracy	Max. test current: 7.5 A 0.100 Ω to 399.99 Ω / ±(5% of measurement + 2 cts)		
	NO TRIP mode (Zs (L-PE))	Test current: 6 mA – 9 mA – 12 mA (as required) - 0.20 Ω to 3,999 Ω ±(5% of measurement + 2 cts)		
	Calculation of short-circuit current I _k (PFC (Zs)) , I _{Sc} (PSCC (Zi))	Fault and short-circuit current: display range 0.1 A to 6 kA		
	Integrated fuse table	Yes		
	Voltage drop ΔU% (Zi)	-40% to + 40%		
	Others	Measurement of the resistive and inductive components of the impedances Zs and Zi		
RCDs				
Type AC and A RCDs	Installation voltage / freq.	90 to 500 V / 15.8 to 17.5 Hz - 45 to 65 Hz		
	IΔn	10 / 30 / 100 / 300 / 500 / 650 / 1,000 mA (90 V – 280 V) or variable - 10 / 30 / 100 / 300 / 500 mA (280-550 V) or variable Ramp and pulse test		
	NO TRIP test	at ½ IΔn – Duration: 1,000 ms or 2,000 ms		
	Trip current Ramp mode	0.3 x IΔn to 1.06 x IΔn in increments of 3.3% x IΔn		
	Trip time measurement Pulse mode	0.2 to 0.5 x IΔn (Uf) / 0.5 x IΔn / 2 x IΔn (selective) / 5 x IΔn. Pulse: 0 to 500 ms, Ramp mode: 0 to 200 ms		
Type B RCDs	Installation voltage / freq.			90 V to 275 V / 15.8 to 17.5 Hz - 45 to 65 Hz
	IΔn: ramp / pulse 2 x IΔn pulse 4 x IΔn			10 / 30 / 100 / 300 / 500 mA 10 / 30 / 100 mA
	Test in ramp mode			0.2 x IΔn to 2.2 x IΔn
	Trip test			1.1x2 or 2.2x2 or 2.2x4 x IΔn
Other measurements				
	Current	(1 mA*) 5.0 mA to 19.99 A (MN77 clamp) / 5.0 mA to 199.9 A (C177 A clamp)		
	Voltage	0 to 550 V _{AC/DC} / DC and 15.8 to 500 Hz		
	Frequency	10 to 500 Hz		
	Phase rotation	20 to 500 V _{AC}		
	Active power	0 to 110 kW in single-phase - 0 to 330 kW in three-phase Simultaneous display of voltage and current waveform		
	Harmonics	Voltage and current / up to 50th order / THD-F / THD-R		
General specifications				
	Large backlit LCD screen, 320 x 240 cts	monochrome graphical 5.7"		colour graphical 5.7"
	Data storage / Communication	1,000 tests / via USB for data transfer and report generation		
	Power supply: rechargeable battery	NiMH 9.6 V rated 4 Ah.		Lithium-ion 10.8 V rated 5.8 Ah
	Battery life	up to 24 hours		up to 30 hours
	Dimensions / weight	280 x 190 x 128 mm / 2.2 kg		
	Ingress protection / EMC	IP 53 / IK04 / IEC 61326-1		
	Electrical safety / Standards	IEC 61010 -1 – 600 V CAT III – 300 V CAT IV – IEC 61557		

*if a voltage is connected to the instrument

CA 6131 - CA 6133

REF.: P01146011

REF.: P01146013

600V
CAT IIIIP
54Auto
Script

★ STRENGTHS

- Earth measurement by stake and loop method
- Continuity measurement at 0.2 A
- Insulation testing
- RCD testing: current and trip time
- Automatic test sequences
- Storage of tests
- Power supply by mains-rechargeable batteries with USB or vehicle cigarette lighter connection

+ ADDITIONAL INFO

- The Android IT-Report software is available to transfer the test results from the CA 6133 and generate reports.
- Find all our applications at <https://play.google.com> by typing Chauvin Arnoux in the search bar.

📦 CONTENTS

CA 6131 and CA 6133 delivered with 1 carrying bag containing:

- 1 neck strap
- 1 three-pole EURO mains cable
- 3 safety cables
- 3 crocodile clips
- 1 test probe
- 1 USB 2 A power supply + 1 USB cable (CA 6133)
- 6 x 1.5 V LR06 batteries (CA 6131)
- 6 Ni MH rechargeable batteries (CA 6133)
- 1 test report with measurement report



⚙️ ACCESSORIES / REPLACEMENT PARTS

Remote-control probe	P01102157
MN73A current clamp (for CA 6133)	P01120439
See all the accessories on page 81	

⚙️ SPECIFICATIONS

	CA 6131	CA 6133
Continuity		
Range / Resolution / Accuracy	0.00 to 9.99 Ω / Cable compensation up to 5 Ω; I ≥ 200 mA / 0.01 Ω / ± (2 %R + 2 cts)	
Resistance		
Range / Resolution / Accuracy	1 to 9,999 Ω — 10.00 to 99.99 kΩ / 1 Ω — 10 Ω / ± (1 %R + 5 cts)	
Insulation		
Test voltage	250 V / 500 V	250 V / 500 V / 1,000 V
Range / Resolution / Accuracy	0.01 to 999.9 MΩ / 10 kΩ or 100 kΩ / ± (3 %R + 3 cts)	
Earth resistance - 3P method		
Range	-	0.50 to 100.0 to 1,000 to 99.99 Ω 2,000 Ω
Resolution	-	0.01 Ω 0.1 Ω 1 Ω
Accuracy	-	±(2 %R + 10 cts) ±(2 %R + 5 cts) ±(2 %R + 5 cts)
Measurement frequency	-	128 Hz
Earth loop measurement (Zs)		
NO TRIP (12 mA)		
Range / Resolution / Accuracy	1 to 2,000 / 1 / ± (5 %R + 2 cts)	
Ik calculation	1 to 999 A	
With TRIP(300 mA)		
Range / Resolution / Accuracy	0.1 to 399.9 Ω / 0.1 Ω / ±(5 %R + 2 cts)	
Ik calculation	1 to 9,999 A	
Fault loop measurement (Zi)		
Type of connection	Banana leads	
Range / Resolution / Accuracy	Measurement current 300 mA; 0.1 to 399.9 Ω / 0.1 Ω / ± (5 %R + 2 cts)	
Ik calculation	1 to 9,999 A	
RCD test		
Installation voltage	90 to 450 V ; 45 to 65 Hz	
Types and calibres	AC and A ; 30 mA - 100 mA - 300 mA - 500 mA - 650 mA	
Trip time	0.5 x IΔN ; 1 x IΔN ; 5 x IΔN / 5.0 to 300 ms	
Trip current	30 mA : -0 .. +(7 %R + 3.3 % IΔN + 2 mA)	
Fault voltage: Range / Resolution / Accuracy	1.0 to 25.0 V — 25.0 to 70.0 V / 0.1 V / ± (15 %R + 3 cts) — ± (5 %R + 2 cts)	
Automatic test sequence	No	RCD, Loop-RCD-Insulation
Voltage & frequency		
Voltage: Range / Resolution / Accuracy	2.0 to 550.0 V _{AC} / 0.1 V / ± (1 %R+2 cts) ; 0.0 to 800.0 V _{DC} / 0.1 V / ± (1 %R+2 cts)	
Frequency: Range / Resolution / Accuracy	30.0 to 999.9 Hz / 0.1 Hz / ±(0.1 %R + 1 ct) - Voltage > 2 V	
Phase rotation	45 to 550 V / 45 to 65 Hz	
Current		
	Via clamp with voltage output using the voltage sensor option (AUX)	Via MN73 A clamp, 2 A calibre: 10.0 mA to 2,400 mA, 200 A calibre: 1.00 to 200 A
AUX sensor function (CA 6131)		
AC+DC range: Range / Resolution / Accuracy	2.0 to 999.9 mV — 1,000 to 1,200 V / 0.1 mV — 1 mV / ±(1 % R + 2 cts)	-
DC range / Resolution / Accuracy	±(0.0 to 999.9 mV) — ±(1,000 to 2,000 V) / 0.1 mV — 1 mV / ±(1 % R + 2 cts)	-
General specifications		
Display	231-segment LCD with blue backlighting	
Data storage	-	30 sites x 99 tests
Communication	-	Bluetooth Class 1 ; range 10 m
Software	-	IT-Report Android application
Power supply	6 x LR 6 or AA batteries	6 NiMH batteries rechargeable via the mains < 6 hours, USB or vehicle cigarette lighter
Battery life	> 1,900 continuity measurements at 1 Ω	> 1,700 continuity measurements at 1 Ω
Dimensions / weight	223 x 126 x 70 mm / Approx. 1.1 kg	
Environment	Operation: 0 to 40 °C / Storage: - 10 to 70 °C (RH 80%)	
Protection	IP 54 (IEC 60 529); IK 04 (IEC 50102)	
Standards / electrical safety	EMC: IEC 61326-1 ; IEC 61010-1 ; IEC 61010-2-030 ; IEC 61010-2-034, 600 V CAT III, 300 V CAT II on charger input	
IEC 61557 compliance	Parts 1, 2, 3, 4, 6, 7 and 10	Parts 1, 2, 3, 4, 5, 6, 7 and 10

CA 6011 - CA 6011 KIT

REF.: P01191611

REF.: P01299926

300 V
CAT IVIP
40IEC
61557-4Diagnostics
& inspection

Education

Energy
efficiency

Transport

Tertiary
& residential

Industries

Competition,
maintenance
& distributionLaboratory
& metrology**★ STRENGTHS**

- Dedicated to continuity testing on protective earth conductors
- Double configuration: continuity tester attached to the reeler and remote continuity tester on the wrist
- Lightweight and compact
- Ergonomic to facilitate operators' work

+ ADDITIONAL INFO

- Triple visual indications:
 - Backlighting (blue / red)
 - Symbols: "Confirmed box" / "X-barred box"
 - Measurement value
- Buzzer
- Vibrator

📦 CONTENTS**CA 6011 KIT** delivered with:

- 1 elastic strap for fixing the measuring unit to your wrist
- 1 waist belt + 1 shoulder belt
- 1 "Cable Reeler No. 01" with 1 green PVC cable 30 m long
- 1 black spiral PVC cable 3.5 m long
- 1 green crocodile clip with Ø 4 mm banana socket
- 1 moulded black test probe
- 1 green PVC cable 0.50 m long
- 1 set of 4 x 1.5 V LR06 alkaline batteries

CA 6011 delivered with:

- 1 elastic strap for fixing the measuring unit to your wrist
- 1 set of 4 x 1.5 V LR06 alkaline batteries

⚙️ SPECIFICATIONS

	CA 6011	CA 6011 KIT
Display	2,000 counts with two-colour backlighting	
Continuity		
Measurement range	0.00 Ω to 2.00 Ω	2.00 Ω to 20.00 Ω
Resolution	10 mΩ	
Measurement current	200 mA	20 mA
	with automatic polarity reversal	
Open-circuit voltage	±(4 V _{DC} < U < 6 V _{DC})	
Resistance		
Measurement range	1.0 Ω to 200.0 Ω	
Resolution	100 mΩ	
Measurement current	10 mA	
Open-circuit voltage	±(4 V _{DC} < U < 6 V _{DC})	
Continuity threshold	Programmable: 1 Ω or 2 Ω	
Compensation of cable resistance	Yes	
Test conformity / non-conformity indication	Configurable: visual, audible and / or vibrating	
Compliance with standards	IEC 61557-1 & IEC 61557-4 IEC 61010-1, IEC 61010-2-030 300 V CAT IV	
Automatic standby mode	10 minutes / deactivatable	
Battery life	30,000 measurements in actual use 4,500 as per IEC 61557-4 protocol	
Power supply	4 x 1.5 V AA / LR6 batteries	
Dimensions (instrument+reeler)	225 x 185 x 135 mm	
Weight	CA 6011 alone: 350 g Reeler with 30 m cable: 1.2 kg	

⚙️ ACCESSORIES / REPLACEMENT PARTS

Cable reeler no.1 30 m	P01295492
Continuity rod	P01102084A
See all the accessories on page 81	

CA 6651

REF.: P01191306



TEST ADAPTER FOR ELECTRIC VEHICLE AC CHARGING STATIONS



★ STRENGTHS

- Adapter for interfacing on the sockets of mode-3 AC vehicle charging stations equipped with a type-2 cable to test the safety and operation of the charging station by means of an installation tester
- Simulation of the presence of an electric vehicle in its various states (CP signal) : A disconnected / B connected / C charging without ventilation / D charging without ventilation
- PE pre-test: safety function to check that no hazardous voltage is present in relation to the protective earth PE
- Indication of the presence of phases L1 / L2 / L3 by 3 LEDs
- Verification of the Proximity Pilot (PP) signal to simulate the different charging currents: 13 A / 20 A / 32 A / 63 A with selection by rotary switch

+ ADDITIONAL INFO

Adapter alone

- Verification of the signals present on the type 2 socket and PE pre-test
- Simulation of vehicle status (battery ready to charge, with or without ventilation)
- Simulation of the PP current to check the status of the charging status

Adapter with CA 6117

- Electrical safety tests
- Connection on 5 sockets, diam. 4 mm, identified as L1 / L2 / L3 / N / PE for connecting the installation tester equipped with banana plugs
- Mains socket offering the possibility of connected the installation tester's 2P+E plug: Schuko socket with 2 metal studs

⚙️ SPECIFICATIONS

CA 6651

TECHNICAL SPECIFICATIONS

PE pre-test	Yes with touch electrode
PP simulation	Open NC, 13 A, 20 A, 32 A, 63 A
CP status	A, B, C, D
CP / PE error	3 buttons on side for error simulation; CP/PE or diode short-circuit and opening of PE
Earth fault PE error	PP switch set to NC
Protection / Acceptable overload	600 V _{RMS}
Outputs	
L1 / L2 / L3 / N and PE measurement terminals	230 V single-phase and 400 V three-phase 50Hz
Mains socket	Max 250 V Cat II 300 V Admissible current: 10 A (fuse)
CP signal terminal	PWM + / -12 V communication protocol
Specifications	
Input voltage	230 V / 400 V _{AC} 50 / 60Hz 10 A
Charging station socket connector	Charging mode 3 adapted to IEC 62196-2 type 2 socket or fixed cable with connector for type 2 vehicle, three-phase
Power socket protection	Internal fuse: T 10 A / 250 V
Measurement compatibility with	
CA 6117 installation tester	Earth loop measurement, 30 mA type-B RCD test (from 6 mA), insulation test at 500 V and continuity –test report
HANSCOPE oscilloscope	Display of PMW waveform between CP and PE

TECHNICAL SPECIFICATIONS

LEDs	X3, blue
EV standards	IEC 61851-1 / IEC 60364-7-722
Safety	EN61010-1, pollution degree 2, CATII-300 V
IP / IK	IP 20 as per IEC60529
Connection socket	Type 2 32 A 3PH+N+PE type E2201 200 / 346 V
Dimensions / weight	Casing dimensions: 174x43x43 mm / Weight: 850 g

📦 CONTENTS

- CA 6651 delivered with 1 carrying bag containing:
- 1 cable equipped with a type-2 socket



⚙️ ACCESSORIES / REPLACEMENT PARTS

Carrying bag

P01298078

CHOOSE YOUR PORTABLE INSULATION TESTER



	CA 6501	CA 6503	CA 6511	CA 6513	CA 6528	CA 6522	CA 6524	CA 6526	CA 6532	CA 6534	CA 6536
	page 46	page 46	page 46	page 46	page 47	page 48	page 48	page 48	page 48	page 49	page 49
Type	Hand-cranked		Analogue			Portable digital					
Test voltage (in V _{DC})											
10										■	■ 1 V increments
25										■	■ 1 V increments
50							■	■	■		■ 1 V increments
100							■	■	■	■	■ 1 V increments
250		■			■	■	■	■		■	
500	■	■	■	■	■	■	■	■		■	
1000		■		■	■	■	■	■			
Max. measured value											
200 MΩ	■										
1 GΩ			■	■							
5 GΩ		■									
11 GΩ					■						
20 GΩ									■		■
40 GΩ						■					
50 GΩ										■	
200 GΩ							■	■			
Continuity	■		■	■	■	■	■	■	■	■	■
Resistance	■			■	■		■	■	■	■	■
Capacitance								■	■		
Leakage current							■	■	■	■	■
Chronometer					■	■	■	■	■	■	■
Programming of test duration					■	■	■	■	■	■	■
Quality ratios											
PI							■	■	■		
DAR							■	■	■		
Graphics											
Data storage							■	■	■	■	
Bluetooth								■	■	■	
Display											
Analogue	■	■	■	■							
LCD					■						
LCD + bargraph						■	■	■	■	■	■
Power supply											
Hand-cranked magneto	■	■									
Batteries			■	■	■	■	■	■	■	■	■

CA 6501 - CA 6503

REF.: P01132503

REF.: P01132504

300 V
CAT IIIIP
54

HAND-CRANKED INSULATION TESTERS



★ STRENGTHS

- Rugged plastic casing ideal for all-terrain use
- Special for on-site use
- Does not require a power supply

⚙️ SPECIFICATIONS

	CA 6501	CA 6503
Insulation		
Test voltage (DC)	500 V	250 V / 500 V / 1,000 V
Range	0.5 to 200 MΩ	1 to 5,000 MΩ
Accuracy	2.5 % of full scale	2.5 % of full scale
Resistance		
Range	45 to 500 kΩ	-
Accuracy	2.5 % of full scale	-
Continuity		
Range	0 to 100 Ω	-
Accuracy	2.5 % of full scale	-
Voltage		
Range	0... 600 V _{AC}	
Frequency	45 to 450 Hz	
Accuracy	3 % of full scale	
Display	Analogue	
Dimensions / weight	120 x 120 x 130 mm / 1.06 kg	
Power supply	Hand-cranked magneto providing a stable voltage	
Ingress protection	IP 54 with cover / IP 52 without cover	
Electrical safety	IEC 61010 - 600 V CAT II / 300 V CAT III	

📦 CONTENTS

- CA 6501** delivered in a shoulder bag
- 2 elbowed / straight PVC leads 1.5 m long (black / red)
 - 2 crocodile clips (black / red)
 - 1 black test probe
- CA 6503** delivered in a shoulder bag
- 3 elbowed / straight PV leads 1.5 m long (black / red / blue)
 - 3 crocodile clips (black / red / blue)
 - 1 black test probe

⚙️ ACCESSORIES / REPLACEMENT PARTS

Bag no. 2	P01298006
CA 1246 thermo-hygrometer	P01654246
See all the accessories on page 81	

CA 6511 - CA 6513

REF.: P01140201

REF.: P01140301

600 V
CAT IIIIP
40

ANALOGUE INSULATION TESTERS



★ STRENGTHS

- Simple to use
- Rugged thanks to their shockproof sheath

⚙️ SPECIFICATIONS

	CA 6511	CA 6513
Insulation		
Test voltage (DC)	500 V	500 V / 1,000 V
Range	0.1 to 1,000 MΩ	
Accuracy	± 5 % of measurement	
Resistance		
Range	-	0 to 1,000 Ω
Accuracy	-	± 3 % of full scale
Continuity		
Range	-10 Ω to +10 Ω	
Accuracy	± 3 % of full scale	
Measurement current	≥ 200 mA	
Current reversal	Yes	
Voltage		
Range	0... 600 V _{AC}	
Frequency	45 to 400 Hz	
Accuracy	3 % of full scale	
Display	Analogue	
Dimensions / weight	167 x 106 x 55 mm / 500 g (excluding sheath)	
Power supply	4 x 1.5 V LR06 batteries	
Electrical safety	IEC 61010 - 600 V CAT III	

➕ ADDITIONAL INFO

- CA 6511 : insulation at 500 V, continuity at 200 mA
- CA 6513 : insulation at 1,000 V, continuity at 200 mA and resistance

📦 CONTENTS

- CA 6511** and **CA 6513** delivered mounted in their shockproof sleeves
- 2 elbowed / straight PVC leads 1.5 m long (black / red)
 - 1 black test probe
 - 1 red crocodile clip
 - 4 x 1.5 V LR06 batteries
 - 1 replacement fuse

⚙️ ACCESSORIES / REPLACEMENT PARTS

CA 1821 thermometer	P01654821
CA 1246 thermo-hygrometer	P01654246
See all the accessories on page 81	

CA 6528

REF.: P01140838

1000 V
CAT III

600 V
CAT IV

IP
40



★ STRENGTHS

- Insulation measurement at 250 / 500 / 1,000 V
- Insulation resistance up to 11 GΩ
- Manual, locked and timer modes
- AC and AC+DC voltage measurement up to 700 V
- Continuity at 200 mA
- Visual alarm, blue / red backlighting

📦 CONTENTS

CA 6528 delivered in hands-free bag containing:

- 2 safety leads (1 red, 1 black)
- 1 red crocodile clip
- 1 black test probe
- 1 protective sheath mounted on the instrument
- 6 x LR6 or AA batteries
- 1 safety datasheet
- 1 Quick Start Guide
- 1 verification certificate



⚙️ SPECIFICATIONS

CA 6528	
Industrial maintenance	
Voltage	
Measurement range / resolution	1-700 V / 1 V
Accuracy / input impedance	±1.2% R ± 1ct for AC+DC; ±1 R ± 1ct for DC / 25 MΩ
Operating frequency	DC ; 45-65 Hz
Insulation	
Test voltage	250-500-1,000 V
Range at maximum test voltage	11 GΩ
Measurement range	250 V 50 kΩ - 4.2 GΩ
	500 V 100 kΩ - 4.2 GΩ
	1 000 V 200 kΩ - 11 GΩ
Measurement range / resolution	50 kΩ - 3.999 / 1 kΩ; (0.2) ¹ ; 3.6-39.99 MΩ / 10 kΩ; 3.6-399.9 MΩ / 100 kΩ; 360-4,200 MΩ / 1 MΩ; (1 kV) 3.6 - 11.00 GΩ / 10 MΩ
Accuracy	0.05-399.9 MΩ : ±1.5 R ± 10 cts; 360-4,200 MΩ: ±4 R ± 10 cts ; ±4 R ± 5 cts (at 1,000 V); 3.6-11 GΩ: ±10 R ± 10 cts
Timer (min:s)	10s to 39min 59s
Alarms	1 threshold / test voltage
Continuity	
Measurement range	0.02 Ω - 40 Ω (200 mA)
Accuracy / open-circuit voltage	±1.2% R ±3 cts / 6 V _{DC} < U < 9 V _{DC}
Measurement current	≥ 200 mA (up to 2 Ω)
Continuity threshold (fast beep)	2 Ω / 1 Ω
Cable compensation	up to 5 Ω
Resistance	
Measurement range / resolution	1 -399.9 Ω / 0.1 Ω; 360-3,999 Ω / 1 Ω; 3.60-39.99 kΩ / 10 Ω; 36.0-420.0 kΩ / 100 Ω
Accuracy	±1.2% R ±3 cts
General specifications	
Display	2 x 4,000 cts
Power supply / Automatic power-off	6 x LR6 or AA batteries / 10 min deactivatable
Battery life	1,000 measurements: at 1 MΩ @ 1 kV (5 s ON / 25 s OFF); >3,000 continuity measurements (5 s ON / 25 s OFF) at 1 Ω
Dimensions / weight / IP rating	218 x 95 x 63 mm / 760 g / IP 40
EMC / electrical safety	IEC 61326-1 / IEC 61010-1, IEC 61010-2-030 and IEC 61010-2-034 / 600 V CAT IV
Compliance with standards	IEC 61557 parties 1, 2, 4 and 10

¹at 1,000 V

⚙️ ACCESSORIES / REPLACEMENT PARTS

Set of red and black safety leads 1.5 m	P01295289Z
Red + black crocodile clips	P01295457Z
Red + black test probes	P01295454Z
Continuity rod	P01102084A
See all the accessories on page 81	

CA 6522 - CA 6524 - CA 6526

REF.: P01140822

REF.: P01140824

REF.: P01140826

600 V
CAT IVIP
54IEC
61557

TRMS

Diagnostics
& inspection

Education

Energy
efficiency

Transport

Tertiary
& residential

Industries

Communication,
information &
distributionLaboratory
& research

SPECIFICATIONS

	CA 6522	CA 6524	CA 6526
Industrial maintenance			
Voltage			
Measurement range / Resolution	0.3 V - 399.9 V / 0.1 V ; 400 V - 700 V / 1 V		
Accuracy / Input impedance	± (3 % + 2 cts) / 400 KΩ		
Operating frequency	DC ; 15.3 - 800 Hz		
Frequency			
Measurement range / Resolution / Accuracy	- 15.3 Hz - 399.9 Hz / 0.1 Hz / ± (1 % + 2 cts) 400 - 800 Hz / 1 Hz / ± (1 % + 1 ct)		
Insulation			
Test voltage	250-500-1,00 V	50 - 100 - 250 - 500 - 1,000 V	
Range at maximum test voltage	40 GΩ	200 GΩ	
Compliance with IEC 61557 - 2 standard	2 GΩ		
Measurement range: 50 V	-	10 kΩ - 10 GΩ	
100 V	-	20 kΩ - 20 GΩ	
250 V	50 kΩ - 10 GΩ	50 kΩ - 50 GΩ	
500 V	100 kΩ - 20 GΩ	100 kΩ - 100 GΩ	
1,000 V	200 kΩ - 40 GΩ	200 kΩ - 200 GΩ	
Measurement range / Resolution	10 ⁰¹ - 999 kΩ and 1,000 - 3,999 MΩ / 1 kΩ ; 4,00 - 39,99 MΩ / 10 kΩ 40,0 - 399,9 MΩ / 100 kΩ ; 400 - 3,999 MΩ / 1 MΩ 4,00 - 39,99 GΩ / 10 MΩ ; 40,0 - 200 GΩ / 100 MΩ		
Accuracy	± (3 % + 2 cts) ²⁾		
Test voltage (I < 1 mA)	- 0 % + 20 %		
Test voltage display	± (3 % + 3 cts)		
Test current / resolution	-	0.01 μA - 39.99 μA / 10 nA ; 40.0 - 399.9 μA / 100 nA ; 0.400 - 2.000 mA / 1 μA	
Accuracy on test current	-	± (10 % + 3 cts)	
PI / DAR ratio	-	10 min / 1 min - 1 min / 30 s	
Timer (min:s)	0:00 - 39:59		
Discharge time (at 25 V)	< 2 s / μF		
Alarms	-	2 fixed thresholds + 1 programmable threshold	
Continuity			
Continuity measurement range	0.00 Ω - 10.00 Ω (200 mA)	0.00 Ω - 10.00 Ω (200 mA)	0.0 - 100.0 Ω (20 mA)
Accuracy / Open-circuit voltage	± (2 % + 2 cts) / > = 6 V		
Measurement current	200 mA : 200 mA (- 0 mA + 20 mA) - 20 mA: 20 mA ± 5 mA		
Continuity thresholds (fast beep)	2 Ω fixed	2 Ω, 1 Ω, programmable threshold	
Cable compensation	up to 9.99 Ω		
Resistance			
Measurement range / Resolution	-	0 - 3999 Ω / 1 Ω 4,00 kΩ - 39,99 kΩ / 10 Ω 40,0 kΩ - 399,9 kΩ / 100 Ω 400 kΩ - 1,000 kΩ / 1 kΩ	
Accuracy	± (3 % + 2 cts)		
Capacitance			
Measurement range / Resolution	-	-	0.1 nF - 399.9 nF / 0.1 nF 400 nF - 3999 nF / 1 nF 4.00 μF - 10.0 μF / 10 nF
Accuracy	-	-	± (3 % + 2 cts)
General specifications			
Display	2 x 4,000 cts + logarithmic bargraph		
Data storage	-	300 measurements	1,300 measurements
Communication	-	-	Bluetooth® Class II
Power supply / Auto power-off	6 x LR6 batteries / 5 min, deactivatable		
Battery life	1,500 measurements: U _N x 1 kΩ @ U _N (5 s ON / 55 s OFF) 3,000 continuity measurements (5 s ON / 55 s OFF)		
Dimensions / weight / IP rating	211 x 108 x 60 mm / 850 g / IP 54 / IK 04		
EMC / Electrical safety	IEC 61326 - 1 / IEC 61010 - 1 and IEC 61010 - 2 - 030, 600 V CAT IV		
Compliance with standards	IEC 61557 parts 1, 2, 4 and 10		

(1): 2 kΩ for the CA 6532 - CA 6534 - CA 6536.

(2): To be added: 10 V: 1 % per 0.1 GΩ; 25 V: 0.4 % per 0.1 GΩ, 50 V: 2 % per GΩ, 100 V: 1 % per GΩ; 250 V: 0.4 % per GΩ; 500 V: 0.2 % per GΩ; 1,000 V: 0.1 % per GΩ.

STRENGTHS

- Test voltage from 50 to 1,000 V
- Measurement range from 10 kΩ to 200 GΩ
- PI and DAR ratios to determine the quality of the insulation
- Alarms and Pass / Fail indicator LEDs (CA 6526)
- Storage of up to 1,300 measurements

CONTENTS

CA 6522, CA 6524 or CA 6526

- 1 "hands-free" bag
- 2 elbowed-straight safety leads (red and black) 1.50 m long
- 1 red crocodile clip
- 1 black test probe
- 6 x LR6 batteries
- 1 CD-ROM containing the multilingual user manual
- 1 safety datasheet in 20 languages

In addition, for the CA 6526: 1 CD-ROM containing the Megohmmeter Transfer software

ACCESSORIES / REPLACEMENT PARTS

Type-3 remote-control probe	P01102092A
2 elbowed-straight safety leads (red and black) 1.50 m long	P01295453Z

See all the accessories on page 81

CA 6532 - CA 6534 - CA 6536

REF.: P01140832

REF.: P01140834

REF.: P01140836

600 V CAT IV IP 54 IEC 61557  TRMS











SPECIFICATIONS

	CA 6532	CA 6534	CA 6536
	Telecom.	Electronics	Avionics, ESD, aerospace, defence
Voltage			
Measurement range / Resolution	0.3 V - 399.9 V / 0.1 V; 400 V - 700 V / 1 V		
Accuracy / Input impedance	± (3 % + 2 cts) / 400 kΩ		
Operating frequency	DC; 15.3 - 800 Hz		
Frequency			
Measurement range / Resolution / Accuracy	15.3 Hz - 399.9 Hz / 0.1 Hz / ± (1 % + 2 cts) 400 - 800 Hz / 1 Hz / ± (1 % + 1 ct)		
Insulation			
Test voltage	50 - 100 V	10-25-100-250-500 V	10 to 100 V 1 V increments
Range at maximum test voltage	20 GΩ	50 GΩ	20 GΩ
Compliance with IEC 61557 - 2 standard	2 GΩ		
Measurement range: 10 V		2 kΩ - 1 GΩ	2 kΩ - 2 GΩ
25 V		5 kΩ - 2 GΩ	(UN / 5) kΩ to (UN / 5) GΩ
50 V	10 kΩ - 10 GΩ		
100 V	20 kΩ - 20 GΩ	20 kΩ - 10 GΩ	20 kΩ - 20 GΩ
250 V		50 kΩ - 25 GΩ	
500 V		100 kΩ - 50 GΩ	
Variable test voltage	10 to 100 V		
Measurement range / Resolution	10(1) - 999 kΩ and 1,000 - 3,999 MΩ / 1 kΩ; 4,00 - 39,99 MΩ / 10 kΩ 40,0 - 399,9 MΩ / 100 kΩ; 400 - 3,999 MΩ / 1 MΩ 4,00 - 39,99 GΩ / 10 MΩ; 40,0 - 200 GΩ / 100 MΩ		
Accuracy	± (3 % + 2 cts) ⁽²⁾		± (3 % + 2 cts) ⁽³⁾
Test voltage (I < 1 mA)	- 0 % + 20 %		± 0.5 V
Test voltage display	± (3 % + 3 cts)		
Test current / resolution	0.01 μA - 39,99 μA / 10 nA; 40,0 - 399,9 μA / 100 nA 0,400 - 2,000 mA / 1 μA		
Accuracy on test current	± (10 % + 3 cts)		
PI / DAR ratio	10 min / 1 min - 1 min / 30 s	-	-
Timer (min:s)	0:00 - 39:59		
Discharge time (at 25 V)	< 2 s / μF		
Alarms	2 fixed thresholds + 1 programmable threshold		
Continuity			
Continuity measurement range	0,00 Ω - 10,00 Ω (200 mA); 0,0 - 100,0 Ω (20 mA)		
Accuracy / Open-circuit voltage	± (2 % + 2 cts) / >= 6 V		
Measurement current	200 mA : 200 mA (- 0 mA +20 mA) - 20 mA : 20 mA ± 5 mA		
Continuity thresholds (fast beep)	2 Ω, 1 Ω, programmable threshold		
Cable compensation	up to 9,99 Ω		
Resistance			
Measurement range / Resolution	0 - 3,999 Ω / 1 Ω; 4,00 kΩ - 39,99 kΩ / 10 Ω ± (3 % + 2 cts) 40,0 kΩ - 399,9 kΩ / 100 Ω 400 kΩ - 1,000 kΩ / 1 kΩ ± (3 % + 2 cts)		
Capacitance			
Measurement range / Resolution	0,1 nF - 399,9 nF / 0,1 nF 400 nF - 3,999 nF / 1 nF 4,00 μF - 10,0 μF / 10 nF		
Accuracy	± (3 % + 2 cts)		
Line length	0 - 100 km		
General specifications			
Display	2 x 4 000 cts + logarithmic bargraph		
Data storage	1,300 measurements		-
Communication	Bluetooth® Class II		-
Power supply / Auto power-off	6 x LR6 batteries / 5 min, deactivatable		
Battery life	1,500 measurements: U _N x 1 kΩ @ U _N (5 s ON / 55 s OFF) 3,000 continuity measurements (5 s ON / 55 s OFF)		
Dimensions / weight / IP rating	211 x 108 x 60 mm / 850 g / IP 54 / IK 04		
EMC / Electrical safety	IEC 61326 -1 / IEC 61010 -1 and IEC 61010 -2 - 030, 600 V CAT IV		
Compliance with standards	IEC 61557 parts 1, 2, 4 and 10		

STRENGTHS

- Test voltage from 50 to 1,000 V
- Measurement range from 10 kΩ to 200 GΩ
- PI and DAR ratios to determine the quality of the insulation
- Alarms and Pass / Fail indicator LEDs (CA 6526)
- Storage of up to 1,300 measurements

CONTENTS

CA 6532, CA 6534 or CA 6536

- 1 "hands-free" bag
- 2 elbowed-straight safety leads (red and black) 1.50 m long
- 1 red crocodile clip
- 1 black test probe
- 6 x LR6 batteries
- 1 CD-ROM containing the multilingual user manual
- 1 safety datasheet in 20 languages
- In addition, for the CA 6526: 1 CD-ROM containing the Megohmmeter Transfer software

ACCESSORIES / REPLACEMENT PARTS

Type-3 remote-control probe	P01102092A
2 elbowed-straight safety leads (red and black) 1.50 m long	P01295453Z

See all the accessories on page 81

(1): 2 kΩ for the CA 6532, CA 6534 and CA 6536.
 (2): To be added: 10 V: 1 % per 0.1 GΩ; 25 V: 0.4 % per 0.1 GΩ; 50 V: 2 % per GΩ; 100 V: 1 % per GΩ; 250 V: 0.4 % per GΩ; 500 V: 0.2 % per GΩ; 1,000 V: 0.1 % per GΩ.
 (3): To be added: 10 % / UN per 100 MΩ

CHOOSE YOUR ON-SITE INSULATION TESTER

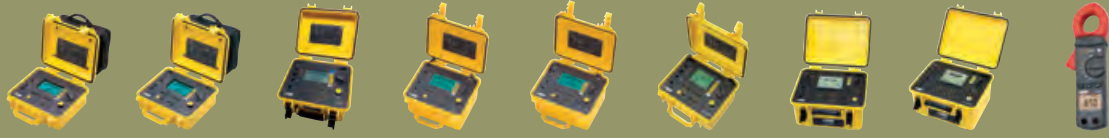

	CA 6541	CA 6543	CA 6505	CA 6545	CA 6547	CA 6549	CA 6550	CA 6555	F65
	page 51	page 51	page 52	page 52	page 53	page 53	page 54	page 54	page 55
Type	On-site digital								Portable
Test voltage (in Vdc)									
50	■	■	■	■	■	■	■	■	
100	■	■	■	■	■	■	■	■	
250	■	■	■	■	■	■	■	■	
500	■	■	■	■	■	■	■	■	
1000	■	■	■	■	■	■	■	■	
2500			■	■	■	■	■	■	
5000			■	■	■	■	■	■	
variable from 50 to 5,100			■	■	■	■	■	■	
10 000							■	■	
variable from 40 to 10,000							■	■	
15 000								■	
variable from 40 to 15 000								■	
Max. measured value									
4 TΩ	■	■							
10 TΩ			■	■	■	■			
25 TΩ							■		
30 TΩ								■	
Continuity	■	■							
Resistance	■	■		■	■	■	■	■	■
Capacitance	■	■	■	■	■	■	■	■	
Leakage current				■	■	■	■	■	■
Chronometer	■	■		■	■	■	■	■	
Programming of test duration	■	■	■	■	■	■	■	■	
Quality ratios									
PI	■	■	■	■	■	■	■	■	
DAR	■	■	■	■	■	■	■	■	
DD				■	■	■	■	■	
Graphics									
R (t)	■	■		■	■	■	■	■	
u (t) + i (t)							■	■	
i (u)							■	■	
Ramp									
Ramp by voltage steps						■	■	■	
Calculation of R. (Tref)						■	■	■	
I limit									
Early break / burn-in							■	■	
Data storage	■	■		■	■	■	■	■	
RS 232		■			■	■			
USB							■	■	
Display									
LCD + bargraph	■	■	■	■	■				
Graphics						■	■	■	
Power supply									
Batteries	■								■
Rechargeable battery		■	■	■	■	■	■	■	

CA 6541 - CA 6543

REF.: P01138901

REF.: P01138902

600 V
CAT IIIIP
53Diagnostics
& inspection

Education

Energy
efficiency

Transport

Buildings
& construction

Industries

Generation,
transmission
& distributionLaboratory
& research

★ STRENGTHS

- Test voltages from 50 V to 1,000 V
- Wide measurement range from 2 kΩ to 4 TΩ
- Automatic calculation of DAR / PI quality ratios
- Communication for CA 6543

📦 CONTENTS

CA 6541 delivered with an accessories bag containing:

- 1 set of 2 leads 1.5 m long (red / blue)
- 1 black guarded lead 1.5 m long
- 3 crocodile clips (red / blue / black)
- 1 test probe (black)
- 8 x LR14 batteries

CA 6543 delivered with an accessories bag containing:

- 1 set of 2 leads 1.5 m long (red / blue)
- 1 black guarded lead 1.5 m long
- 3 crocodile clips (red / blue / black)
- 1 test probe (black)
- 1 power-supply lead 2 m long
- 1 communication cable

⚙️ SPECIFICATIONS

	CA 6541	CA 6543
Insulation		
Test voltage		
50 V	2 kΩ to 200 GΩ	
100 V	4 kΩ to 400 GΩ	
250 V	10 kΩ to 1 TΩ	
500 V	20 kΩ to 2 TΩ	
1000 V	40 kΩ to 4 TΩ	
Accuracy		
2 kΩ to 40 GΩ	±5 % of value ± 3 cts	
40 GΩ to 4 TΩ	±15 % of value ± 10 cts	
Programming of test duration	1 to 59 min.	
DAR (1 min. / 30 sec.)	0.000 to 9.999	
PI (10 min. / 1 min.)	0.000 to 9.999	
Customizable PI	Time customizable from 30 s to 59 min.	
Voltage test / Safety	0 to 1000 V _{AC/DC}	
Voltage alert indicator	Yes > 25 V	
Test inhibition	Yes > 25 V	
Smoothing function	Yes	
Continuity		
Range	0.01 to 39.99 Ω	
Measurement current	≥ 200 mA up to 20 Ω	
Resistance		
Range	0.01 to 400 kΩ	
Capacitance		
Range	0.005 to 4.999 μF	
Data storage - Communication		
Storage of R(t)	Memory 20 kB	Memory 128 kB
Storage of measurements	20 measurement results	Up to 1,500 measurement results
Direct report printing	-	On locally-connected printer, fixed format
Communication port	No	RS232
PC software	No	DataView® (option)
Display	Giant LCD + bargraph	Giant LCD + bargraph
Power supply	8 x LR14 batteries	NiMH rechargeable battery
Dimensions / weight	240 x 185 x 110 mm / 3.4 kg	
Electrical safety	IEC 61010 600 V CAT III – IEC 61557	

⊕ ADDITIONAL INFO

- Site-proof casing with highly shock-resistant lid
- Delivered with an accessories bag which can be clipped onto the site-proof casing

⚙️ ACCESSORIES / REPLACEMENT PARTS

Remote control probe	P01101935
CA 1821 thermometer	P01654821
See all the accessories on page 81	

CA 6505 - CA 6545

REF.: P01139714

REF.: P01139711

1000 V
CAT III600 V
CAT IVIP
53Diagnostics
& inspection

Education

Energy
efficiency

Transport



Energy & environment



Industries

Generation,
transmission
& distributionLaboratory
& research

SPECIFICATIONS

	CA 6505	CA 6545
Insulation		
Test voltage		
500 V	10 kΩ to 2 TΩ	
1000 V	100 kΩ to 4 TΩ	
2500 V	100 kΩ to 10 TΩ	
5000 V	300 kΩ to 10 TΩ	
Voltage programming	40 V to 1,000 V: 10 V increments 1,000 V to 5,100 V: 100 V increments	
Accuracy		
1 kΩ to 400 GΩ	±5 % of value ± 3 cts	
400 GΩ to 10 TΩ	±15 % of value ± 10 cts	
Programming of test duration	1 to 59 min.	
DAR (1 min. / 30 sec.)	0.02 to 50.00	
PI (10 min. / 1 min.)	0.02 to 50.00	
Customizable PI	Time adjustable from 30 s to 59 min.	
DD	-	0.02 to 50.00
Voltage test / safety	0 to 1000 V _{AC} / DC	
Voltage alert indicator	Yes > 25 V	
Test inhibition	Yes > 25 V	Yes – Adjustable according to test voltage
Smoothing function	-	Configurable – Digital filtering to stabilize the measurements
Capacitance	0.005 to 49.99 μF	
Leakage current measurement	0.001 nA to 3 mA	
Data storage – Communication		
Storage of R(t)	-	4 kB memory
Storage of measurements	-	20 measurement results
Display	Giant LCD + bargraph	
Power supply	NiMH rechargeable battery	
Dimensions / weight	270 x 250 x 180 mm / 4.3 kg	
Electrical safety	IEC 61010 1000 V CAT III - 600 V CAT IV IEC 61557	

STRENGTHS

- Fixed and programmable test voltages from 40 V to 5,100 V
- Wide measurement range from 30 kΩ to 10 TΩ
- Measurement filtering functions
- Automatic calculation of DAR / PI / DD quality ratios
- Measurement of voltage, capacitance and leakage current

CONTENTS

CA 6505 - CA 6545 delivered with a shoulder bag containing:

- 2 safety leads 3 m long with HV plug and HV crocodile clip (red / blue)
- 1 guarded safety lead 3 m long with rear-connection HV plug and HV crocodile clip (black)
- 1 cable with rear connection (blue) 0.35 m long
- 1 mains power cable 2 m long

ADDITIONAL INFO

- Highly shock-resistant site-proof casing
- Delivered with a carrying bag

ACCESSORIES / REPLACEMENT PARTS

CA 1246 thermo-hygrometer	P01654246
CA 1821 thermometer	P01654821
See all the accessories on page 81	

CA 6547 - CA 6549

REF.: P01139712

REF.: P01139713

1000 V
CAT III

600 V
CAT IV

IP
53



★ STRENGTHS

- Fixed and programmable test voltages from 40 V to 5,100 V
- Wide measurement range from 30 kΩ to 10 TΩ
- Measurement filtering functions
- Automatic calculation of DAR / PI / DD quality ratios
- Graphical display of R(t) curves (CA 6549)
- Resistance calculation at a reference temperature (CA 6549)

📦 CONTENTS

- CA 6547 - CA 6549** delivered with a shoulder bag containing:
- 2 safety leads 3 m long with HV plug and HV crocodile clip (red / blue)
 - 1 guarded safety lead 3 m long with rear-connection HV plug and HV crocodile clip (black)
 - 1 cable with rear connection (blue) 0.35 m long
 - 1 mains power cable 2 m long
 - 1 communication cable

⚙️ SPECIFICATIONS

	CA 6547	CA 6549
Insulation		
Test voltage		
500 V		30 kΩ to 2 TΩ
1,000 V		100 kΩ to 4 TΩ
2,500 V		300 kΩ to 10 TΩ
5,000 V		300 kΩ to 10 TΩ
Voltage programming		40 V to 1,000 V: 10 V increments 1,000 V to 5,100 V: 100 V increments
Test by voltage steps	-	Programmable value and duration up to 5 increments, three profiles memorized
Accuracy		
30 kΩ to 40 GΩ		±5 % of value ± 3 cts
40 GΩ to 10 TΩ		±15 % of value ± 10 cts
Programming of test duration		1 to 59 min.
DAR (1 min. / 30 sec.)		0.02 to 50.00
PI (10 min. / 1 min.)		0.02 to 50.00
Customizable PI		Time customizable from 30 s to 59 min.
DD		0.02 to 50.00
Voltage test / safety		0 to 1,000 Vac / DC
Voltage alert indicator		Yes > 25 V
Test inhibition		Yes – Adjustable according to test voltage
Smoothing function		Configurable – Digital filtering stabilizing the measurements
Capacitance		0.005 to 49.99 µF
Leakage current measurement		0.001 nA to 3 mA
Data storage – Communication		
Storage of R(t)	Storage 128 kB	Display on screen + Storage of samples
Storage of measurements		Up to 1,500 measurement results
Direct report printing	On locally-connected printer, fixed format	Dump of measurements onto PC
Communication port		USB
PC software		DataView® (option)
Display	Giant LCD + bargraph	Wide graphical screen
Power supply		NiMH rechargeable battery
Dimensions / weight		270 x 250 x 180 mm / 4.3 kg
Electrical safety		IEC 61010 1000 V CAT III - 600 V CAT IV – IEC 61557

➕ ADDITIONAL INFO

- Test by voltage steps (CA 6549)
- Compatible with the DataView® software

⚙️ ACCESSORIES / REPLACEMENT PARTS

CA 1246 thermo-hygrometer	P01654246
CA 1821 thermometer	P01654821
See all the accessories on page 81	

CA 6550 - CA 6555

REF.: PO1139715

REF.: PO1139716

1000 V
CAT IVIP
54Diagnostics
& inspection

Education

Energy
efficiency

Transport

Energy
& construction

Industries

Generation,
transmission
& distributionLaboratory
& research

SPECIFICATIONS

	CA 6550	CA 6555
Test voltages	10 kV	15 kV
Insulation measurement		
Ranges	500 V: 10 kΩ to 2 TΩ 1,000 V: 10 kΩ to 4 TΩ 2,500 V: 10 kΩ to 10 TΩ 5,000 V: 10 kΩ to 15 TΩ 10,000 V: 10 kΩ to 25 TΩ	15,000 V: 10 kΩ to 30 TΩ
Fixed test voltages	500 / 1,000 / 2,500 / 5,000 / 10,000 V	500 / 1,000 / 2,500 / 5,000 / 10,000 / 15,000 V
Variable test voltages	40 V – 10,000 V 3 preconfigurable voltage values	40 V – 15,000 V 3 preconfigurable voltage values
Adjustment increment for variable voltages	Variable: 40-10 kV Increment: 40 V - 1 kV: 10 V 1 kV - 10 kV: 100 V	Variable: 40-15 kV Increment: 40 V - 1 kV: 10 V 1 kV - 15 kV: 100 V
Ramp mode	3 preconfigurable ramps: start voltage / end voltage / duration	
Ramp configuration range	40-1,100 V / 500-10,000 V	40-1,100 V / 500-15,000 V
Step mode	Up to 10 plateaux (values and duration configurable for each plateau)	
Voltage measurement before and after test	AC: 0 – 2,500 V DC: 0 – 4,000 V	
Capacitance measurement (> 500 V)	0.001-9.999 μF / 10.00-19.99 μF	
Leakage current measurement	0 - 8 mA	
Discharge after test	Yes / automatic	
Additional test stop modes		
I-limite	Programmable 0.2 - 5 mA	
Early-break	di / dt	
Timer	Up to 99:59 minutes	
Debug mode		
Burn-in	Permanent test	
Calculation of ratios	PI, DAR, DD, SV, ΔR (ppm / V)	
Calculation of R at ref. temp.	Yes	
Measurement display filter	3 filters with variable time constant	
Graphics on display	R(t)+u(t) ; i(t) ; i(u)	
Data storage	256 recordings, 80,000 cts R, U, I and date-stamp	
Communication	Optically-isolated port for USB and RS232 connection	
PC software	DataView®	
Power supply	NiMH rechargeable batteries, 8 x 1.2 V / 4,000 mAh Charging by 90-260 V 50/60 Hz external voltage	
Electrical safety	1000 V CAT IV - IEC 61010-1 and IEC 61557	
Dimensions / weight	406 x 330 x 174 mm, 6 kg approx.	

STRENGTHS

- Fixed and programmable test voltages from 40 V to 10 / 15 kV
- Wide measurement range from 10 kΩ to 30 TΩ
- 5 mA charging current
- Digital graphical display and bargraph of the R(t) + U(t), i(t) and i(u) curves in real time
- Ramp and voltage step tests

CONTENTS

CA 6550 and CA 6555 delivered with a shoulder bag containing:

- 2 safety leads 3 m long equipped with an HV plug at each end (red / blue)
- 1 guarded safety lead 3 m long equipped with an HV plug at one end and an HV plug with rear connection at the other end (black)
- 3 crocodile clips (red, blue, black)
- 2 x CAT IV 1000 V test probes (red / black) for voltage measurement
- 1 blue lead 0.5 m long with rear connection
- 1 mains power cable 2 m long
- DataView® software
- 1 optical / USB communication cable
- 1 CD-Rom containing the user's manual

ADDITIONAL INFO

- Resistance calculation at a reference temperature
- memory capacity: 80.000 measurements
- Optically-isolated USB communication
- 2 levels of diagnostics available :
 - Go / No go
 - Qualitative measurement for preventive maintenance

ACCESSORIES / REPLACEMENT PARTS

Set of 3 red, blue and black simplified HV safety leads with rear connection	P01295465
3 red / blue / black crocodile clips	P01103062
See all the accessories on page 81	

F65

REF.: P01120761

10 μ A

10,000 counts

TRMS



★ STRENGTHS

- Quick leakage-current testing
- Troubleshooting of insulation faults on live installations
- 50 / 60 Hz filter

📦 CONTENTS

F65 delivered with 1 shoulder bag

- 1 set of straight banana / elbowed banana leads
- 1 set of safety test probes
- 2 x 1.5 V LR03 batteries

⚙️ ACCESSORIES / REPLACEMENT PARTS

Red + black crocodile clips in blister pack (set of 2)	P01295457Z
Elbowed test-probe leads, 1.5 m (1 red / 1 black)	P01295456Z
See all the accessories on page 81	

⚙️ SPECIFICATIONS

				F65	
Display				10,000 counts - 2 measurements / s	
Acquisition				TRMS	
Function	Unit	Calibre	Resolution	Accuracy	
with 50-60 Hz filter					
Current	mA _{AC}	60 mA	10 μ A	1.2 % \pm 5 cts	2.5 % \pm 5 cts (60-500 Hz)
		600 mA	100 μ A		3.5 % \pm 10 cts (500-3 kHz)
	A _{AC}	10 A	1 mA	1.2 % \pm 5 cts	2.5 % \pm 5 cts (60-500 Hz)
		80 A	10 mA		3.5 % \pm 10 cts (500-3 kHz)
		100 A		5 % \pm 5 cts	5 % \pm 5 cts (50-60 Hz)
Voltage	V _{AC}	600 V	0.1 V	1.0 % \pm 5 cts (50-60 Hz) 1.2 % \pm 5 cts (60-500 Hz) 2.5 % \pm 5 cts (500-3 kHz)	
	V _{DC}	600 V	0.1 V	1 % \pm 2 cts	
Resistance	Ω	1 k Ω	0.1 Ω	1 % + 3 cts	
Audible continuity	Buzzer < 35 Ω			(V _{TEST} \leq 3.3 V _{DC})	
Frequency	A	100 Hz 1 kHz	0.1 Hz 1 Hz	0.5 % \pm 2 cts (I > 10 mA)	
	V	100 Hz 1 kHz	0.1 Hz 1 Hz	0.5 % \pm 2 cts (V > 5 V _{AC})	
Max. value				100 ms	
Backlighting				Yes	
Deactivatable automatic power-off				Yes	
Clamping diameter				28 mm	
Dimensions / weight				218 x 64 x 30 mm / 280 g (with batteries)	
Standards				IEC 61010-1 / IEC 61010-2-032 / IEC 61010-2-033	
Installation category				300 V CAT III	
Enclosure protection rating				IP 30 as per EN 60529	



CHOOSE YOUR EARTH TESTER



CA 6422	CA 6424	CA 6460	CA 6462	CA 6470N TERCA 3	CA 6471	CA 6472	CA 6416	CA 6417	CA 6418
page 57	page 57	page 58	page 58	page 59	page 59	page 60	page 62	page 62	page 62

Type	Earth testers			Earth and resistivity testers				Earth testers		
Earth										
3P method	■	■	■	■	■	■	■			
4P method			■	■	■	■	■			
Automatic coupling					■	■	■			
Selective earth										
Earth clamp								■	■	■
4P method + clamp						■	■			
2-clamp method						■	■			
Pylon earth measurement*							■			
Resistivity										
Manual			■	■						
Automatic					■	■	■			
Contact voltage measurement								■	■	
Potential measurement			■	■	■	■	■			
Continuity					■	■	■			
Earth potential							■			
Measurement frequency										
Single frequency: 128 Hz	■	■	■	■						
Single frequency: 2,083 Hz								■	■	■
41 to 512 Hz					■	■				
41 to 5,078 Hz							■			
Measurement of Rs, Rh					■	■	■			
Measurement of Ustray					■	■	■			
Display										
Analogue										
LCD	■		■	■						
LCD, 3 displays		■			■	■	■			
OLED								■	■	■
Data storage / Communication										
Data storage		■ (52% / 62% / 72%)			■	■	■	■	■	■
Communication					■	■	■		■	
Optical USB interface					■	■	■			
Bluetooth®									■	
Power supply										
Batteries	■		■					■	■	■
Rechargeable batteries		■		■	■	■	■			
PC / Tablet software										
GTT / DataView®					■	■	■			
GTC									■	
Tablet application									■	

* Associated with CA 6474

CA 6422 - CA 6424

REF.: P01127012

REF.: P01127014

600 V
CAT IVIP
65CEI
61557**★ STRENGTHS**

- 2P resistance / 3P earth resistance measurement up to 50 kΩ for highly resistive terrain
- Automatic stabilization of the measurement
- Calculation of 52% / 62% / 72% average and % deviation
- Leakage current measurement from 0.5 mA
- Power supply by batteries rechargeable via the mains, USB socket or vehicle cigarette lighter

📦 CONTENTS

- **CA 6422** delivered with 6 x LR6 type AAA batteries, 1 quick start guide, 1 safety datasheet, 1 test report with measurement results, WEB link / QR Code for downloading the manuals
- **CA 6424** delivered with 1 carrying bag, 6 NiMH batteries, 1 USB 2 A power supply, 1 USB micro-razor power cable, 1 multilingual quick start guide, 1 safety datasheet, 1 battery datasheet, 1 test report with measurement results, WEB link / QR Code for downloading the manuals

🔧 ACCESSORIES / REPLACEMENT PARTS

Carrying bag	P01298006
G72 current clamp	P01120872
4-point hands-free strap	HX0302
15 m earth kit	P01102017
50 m expert earth kit	P01102021

See all the accessories on page 81

⚙️ SPECIFICATIONS

	CA 6422	CA 6424
Voltage (UHE)		
Range	-	0.1-600 V
Resolution	-	0.1 V
Accuracy	-	± (1 %R + 1 ct)
2P resistance		
Range	0.05-99.99 Ω / 80.0-999.9 Ω / 0.800-9.999 kΩ / 8.00-50.00 kΩ	
Resolution	0.01 Ω / 1 Ω / 10 Ω / 100 Ω	
Accuracy	± (2 %R + 10 cts) / ± (2 %R + 2 cts) / ± (2 %R + 1 ct) / ± (2 %R + 1 ct)	
Cable compensation	-	up to 5 Ω
3P earth resistance		
Range	0.5 Ω - 2.000 kΩ	0.5 Ω - 50.00 kΩ
Resolution	0.01 Ω / 0.1 Ω / 1 Ω	0.01 Ω / 0.1 Ω / 1 Ω / 10 Ω
Accuracy	± (1 %R + 10 cts) / ± (1 %R + 2 cts) / ± (1 %R + 1 ct)	
Measurement frequency	128 Hz or 256 Hz	
No-load voltage	±10 V peak	
Measurement mode	One-shot or permanent	
Data storage	Registers: RE @ 62%; RE @ 52%; RE @ 72%	
Calculation of average	-	Calculation of the average and the % deviation in relation to the average
RH stake resistance measurement		
Range	-	0.05-9.999 kΩ / 8 - 49.99 kΩ
Resolution	-	1 Ω / 10 Ω
Accuracy	-	±(10 %R + 1 ct)
U_{SE} voltage measurement		
Range	-	0.10 - 99.99 V _{AC} / 80.0 - 600 V _{AC}
Resolution	-	0.01 V / 0.1 V
Accuracy	-	±(2 %R + 2 cts)
Current measurement (via optional G72 clamp)		
Range	0.5 - 999.9 mA / 0.800-9.999 A / 8.00-60.00 A	
Resolution	0.1 / 1 / 10 mA	
Accuracy	±(1 %R + 4 cts) / ±(1 %R + 2 cts)	
Display	Backlit custom 206-segment LCD	
Measurement mode	R 2P (Ω), R 3P (Ω)	V, I, R 2P (Ω), R 3P (Ω)
Power supply	6 x LR 6 or AA batteries	6 x NiMH rechargeable batteries, charging time approx.. 6 hrs
Charger	-	Internal via mains / USB adapter supplied
Automatic power-off	-	Deactivatable
Battery life	> 2,000 x 3P earth measurements at 100 Ω	>1,500 x 3P earth measurements at 100 Ω
Dimensions / weight	223 x 126 x 70 mm / 1 kg	
Environment	Operation: -10 to +50°C / Storage: -40 to +70°C (without batteries / accumulators)	
Protection	Up to 600 V on any of the input terminals	
IP / IK index	IP 65 as per IEC 60529 / IK 04 as per IEC 50102	
Drop test	1 metre as per IEC 61010-1	
Standards / electrical safety	EMC: IEC 61326-1; IEC 61010-2-030 / 600 V CAT IV	
Compliance with IEC 61557	IEC 61557-1 and IEC 61557-5	

CA 6460 - CA 6462

IP
53

REF.: P01126501

REF.: P01126502

Diagnostics
& inspection

Education

Energy
efficiency

Transport

Tertiary
& residential

Industries

Generation,
transmission
& distributionLaboratory
& metrology

EARTH / RESISTIVITY / COUPLING TESTERS



ACCESSORIES / REPLACEMENT PARTS

European 2P mains lead	P01295174
HRC fuse 0.1 A - 250 V (x 10)	P01297012

See all the accessories on page 81

★ STRENGTHS

- 3-in-1 testers: resistivity, earth and coupling
- Validation of the measurement by self-diagnosis: 3 LEDs indicating the presence of faults liable to make the measurement result invalid
- Highly-resistant site-proof casing with lid for use in harsh field conditions
- Large LCD display with backlighting

📦 CONTENTS

CA 6460 delivered with 8 x 1.5 V LR06 batteries

CA 6462 delivered with 1 mains lead for recharging

⚙️ SPECIFICATIONS

	CA 6460	CA 6462
Measurement	Earth / resistivity / coupling	
Type	3P & 4P	
Measurement range	0.01 to 2,000 Ω (in 3 automatic calibres)	
Resolution	10 mΩ / 100 mΩ / 1 Ω (depending on calibre)	
Accuracy	± (2 % + 1 ct)	
No-load voltage	≤ 42 V peak	
Frequency	128 Hz	
Alarms	3 fault presence LEDs	
Power supply	8 x 1.5 V LR06 batteries	NiMH rechargeable battery
Display	2,000-count digital LCD	
Electrical safety	IEC 61010 & IEC 61557	
Dimensions	273 x 247 x 127 mm (handle folded away)	
Weight	2.8 kg	3.3 kg

CA 6470N TERCA 3 - CA 6471

REF.: P01126506

REF.: P01126505

IP
5350 V
CAT IVDiagnostics
& inspection

Education

Energy
efficiency

Transport

Tertiary
& residential

Industries

Generation,
transmission
& distributionLaboratory
& research

CA 6470N TERCA 3
EARTH / RESISTIVITY /
COUPLING / CONTINUITY TESTER

CA 6471
EARTH / SELECTIVE EARTH /
RESISTIVITY / COUPLING /
CONTINUITY TESTER

★ STRENGTHS

CA 6470N TERCA 3:

- 4-in-1 tester: Earth / Resistivity / Coupling / Continuity

CA 6471

- 5-in-1 tester, Earth / Selective Earth / Resistivity / Coupling / Continuity
- Suitable for industry, housing and electricity companies



CONTENTS

CA 6470N delivered with :

- 1 mains adapter
- 1 x 2-pole mains power cable for battery recharging on the mains
- Data export software
- 1 optical / USB communication cable
- 1 CD-Rom containing the user manual
- 5 specifications labels



CONTENTS

CA 6471 delivered with:

- 1 mains adapter
- 1 x 2-pole main power cable for battery recharging on the mains
- Data export software
- 1 optical / USB communication cable
- 2 x C182 clamps with 2 safety leads
- 1 carrying bag
- 1 CD-Rom containing the user manual
- 5 specifications labels

⚙️ SPECIFICATIONS

	CA 6470N	CA 6471
3P method		
Range (automatic selection)	0.01 Ω to 99.9 kΩ	
Resolution	0.01 to 100 Ω	
Test voltage	16 V or 32 V, selectable	
Measurement frequency	41 to 513 Hz, automatic or manual	
Test current	Up to 250 mA	
Accuracy	± 2 % of value ± 1 ct	
4P method		
Range	0.001 Ω to 99.99 kΩ	
Resolution	0.001 to 10 Ω	
Test voltage	16 V or 32 V	
Measurement frequency	41 to 513 Hz, automatic or manual	
Test current	Up to 250 mA	
Measurement accuracy	± 2 % of value ± 1 ct	
4P method + 1 clamp		
	Same as 4P method	
Soil resistivity measurement		
Measurement method	Wenner or Schlumberger method with automatic calculation of the results and display in Ω-metre	
Range (automatic selection)	0.01 Ω to 99.99 kΩ (max. r. 999 kΩm)	
Resolution	0.01 Ω to 100 Ω	
Test voltage	16 or 32 V, selectable	
Measurement frequency	41 to 128 Hz, selectable	
Measurements with 2 clamps		
Range	0.1 to 500 Ω	
Resolution	0.01 to 1 Ω	
Measurement frequency	Auto: 1611 Hz Manual: 128 Hz – 1,367 Hz – 1,611 Hz – 1,758 Hz	
External voltage measurement		
Range (automatic selection)	0.1 to 65.0 V _{AC} / DC – DC and 15-440 Hz	
Accuracy	± 2 % of value ± 1 ct	
Resistance / Continuity - (earth bond test)		
Type of measurement	2P or 4P method, selectable	
Range (automatic selection)	2P: 0.01 Ω to 99.9 kΩ 4P: 0.001 Ω to 99.99 kΩ	
Accuracy	± 2 % of value ± 2 cts	
Test voltage	16 V _{DC} (polarity +. – or auto)	
Test current	> 200 mA for R < 20 Ω	
Data storage		
Storage capacity	512 test results	
Communication	Optically-isolated USB	
Power supply	Rechargeable battery	
Charger power supply	External power supply with 18 V _{DC} / 1.5 A output or 12 V _{DC} vehicle power supply	
Dimensions / weight	272 x 250 x 128 mm / 3.2 kg	
Electrical safety	50 V CAT IV	

⚙️ ACCESSORIES / REPLACEMENT PARTS

DataView® report generation software	P01102095
Adapter for battery charging on vehicle cigarette lighter	P01102036B
See all the accessories on page 81	

CA 6472

REF.: P01126504

IP
5350 V
CAT IVEARTH / SELECTIVE EARTH / RESISTIVITY /
COUPLING / CONTINUITY / PYLON EARTH TESTER

★ STRENGTHS

- All types of earth resistance measurement & pylon earth measurement (with the CA 6474)
- Resistivity (Wenner + Schlumberger methods)
- Earth coupling
- Soil potential measurement
- Continuity / resistance

📦 CONTENTS

CA 6472 delivered with:

- 1 mains adapter
- 1 x 2-pole mains power cable for battery recharging on the mains
- Data export software
- 1 optical / USB communication cable
- 2 x C182 clamps with 2 safety leads
- 1 carrying bag
- 1 CD-Rom containing the user manual
- 5 specifications labels

⚙️ SPECIFICATIONS

	CA 6472
3P measurements	
Range (automatic selection)	0.01 Ω to 99.9 kΩ
Resolution	0.01 Ω to 100 Ω
Test voltage	10 V, 16 V, 32 V _{RMS} or 60 V, selectable
Measurement frequency	41 to 5,078 Hz, automatic or manual
Test current	Up to 250 mA
Accuracy	± 2 %R +1 ct to 128 Hz
Measurements with 2 clamps	
Range	0.01 to 500 Ω
Resolution	0.01 to 1 Ω
Measurement frequency	Auto: 1,611 Hz - Manual: 128 Hz – 1,367 Hz – 1,611 Hz – 1,758 Hz
4P method / 4P+clamp	
Range	0.001 Ω to 99.99 kΩ
Resolution	0.001 to 10 Ω
Test voltage	10 V, 16 V, 32 V or 60 V, selectable
Measurement frequency	41 to 5078 Hz, automatic or manual
Test current	Up to 250 mA
Measurement accuracy	± 2 % of value ± 1 ct
Soil resistivity measurement - 4P method	
Measurement method	Wenner or Schlumberger method with automatic calculation of the results and display
Range (automatic selection)	0.01 to 99.99 kΩ ; ρ max. 999 kΩm
Resolution	0.01 Ω to 100 Ω
Test voltage	10 V, 16 V, 32 V or 60 V, selectable
Measurement frequency	41 to 512 Hz, selectable
Earth potential measurement	
Measurement range	0.00 to 65.00 V
Resolution	0.01 mV to 10 mV
Measurement frequency	41 to 5,078 Hz
Accuracy	± 5 % ± 1 ct to 128 Hz
External voltage measurement	
Range (automatic selection)	0.1 to 65.0 V _{AC/DC} - DC and 15-450 Hz
Accuracy	± 2 % of value ± 1 ct
Resistance / Continuity measurement	
Type of measurement	2P or 4P method, selectable
Range (automatic selection)	2P : 0.01 Ω to 99.9 kΩ 4P : 0.001 Ω to 99.99 kΩ
Accuracy	± 2 % of value ± 2 cts
Test voltage	16 V _{DC} (polarity +, - or auto)
Test current	> 200 mA for R < 20 Ω
Data storage	
Storage capacity	512 test results
Communication	Optically-isolated USB
Power supply	Rechargeable battery
Charger power supply	External power supply with 18 V _{DC} / 1.9 A output or 12 V _{DC} vehicle power supply
Dimensions / weight	272 x 250 x 128 mm / 3.2 kg
Electrical safety	50 V CAT IV

⚙️ ACCESSORIES / REPLACEMENT PARTS

DataView® report generation software	P01102095
Adapter for battery charging on vehicle cigarette lighter	P01102036B
See all the accessories on page 81	

CA 6474

REF.: P01126510

IP
53

SPECIALLY FOR MEASUREMENTS ON PYLONS



★ STRENGTHS

- Used with the CA 6472 for measurements on pylons
- Pylon earth resistance
- Resistance of each pylon footing
- Quality of overhead earth wire connection

📦 CONTENTS

CA 6474 delivered with an accessories bag containing:

- 1 connection cable
- 4 BNC / BNC cables 15 m long
- 4 AmpFlex® flexible current sensors 5 m long
- 1 set of 12 identification rings for AmpFlex® with 15 m BNC cable
- 2 cables (5 m green, 5 m black) with safety plugs on winder
- 5 spade lug / Ø 4 mm banana plug adapters
- 3 adjustable clamps
- 1 calibration loop
- 5 specifications labels

Also available with 8 m AmpFlex® sensor: order reference P01126511



⚙️ SPECIFICATIONS

CA 6474 / PYLON BOX	
Measurements	
Type of measurement	Overall pylon earth resistance Earth resistance of each pylon footing Overall line impedance Quality of overhead earth wire connection. Active measurement (injection by the CA 6472) Passive measurement (use of eddy currents)
Range	0.067 Ω to 99.99 kΩ
Accuracy	± (5 % + 1 ct)
Frequency	41 to 5,078 Hz
Frequency sweep	Yes
Dimensions	272 x 250 x 128 mm
Weight	2.3 kg
Power supply / Data storage / Display	Provided by the CA 6472

+ ADDITIONAL INFO

Possibility of connecting several AmpFlex® sensors in series for a length > 8 metres

The complete Pylon Earth Kit is available to order with the code P01299930. It comprises:

- CA 6472
- CA 6474
- AmpFlex® 5 m
- 100 m earth kit

For the 8 m AmpFlex® version of the complete pylon earth kit, please order:

- CA 6472 reference P01126504
- CA 6474 reference P01126511
- 100 m earth kit reference P01102024

⚙️ ACCESSORIES / REPLACEMENT PARTS

Connection cable between the CA 6472 and CA 6474	P01295271
15 m BNC / BNC cable	P01295272
See all the accessories on page 81	

CA 6416 - CA 6417

REF.: P01122015

REF.: P01122016

600 V
CAT IVIP
40

CA 6418

REF.: P01122018

100 V
CAT IV150 V
CAT IIIIP
40

★ STRENGTHS

- Quick earth-loop testing
- OLED screen and force compensation system
- Loop resistance measurement from 0.01 to 1,500 Ω (1,200 Ω on CA 6418)
- Current measurement from 0.5 mA to 20 A
- Alarms available on Ω and A, and on voltage with CA 6416 / CA 6417
- Storage of 300 time / date-stamped measurements; 2,000 on CA 6417
- Automatic display hold when the clamp is opened

+ ADDITIONAL INFO

- Automatic calibration of jaw gap at power-up
- Oblong head for clamping all types of earth busbars (CA 6418)
- Android application downloadable from Google Play (CA 6417)

📦 CONTENTS

- 1 clamp delivered in a carrying case
- 4 x 1.5 V LR06 batteries
- 1 verification certificate
- 1 CD-ROM containing the user's manual

The CA 6417 is delivered with the simplified GTC driver as well.

⚙️ SPECIFICATIONS

	CA 6416	CA 6417	CA 6418
Loop ohmmeter	Measurement ranges (Ω) / Resolution (Ω) / Accuracy		
	0.010 to 0.099 / 0.001 / ±1.5 % ±0.01 Ω		0.010 to 0.099 / 0.001 / ±1.5 %R ±0.01 Ω
	0.10 to 0.99 / 0.01 / ±1.5 % ±2 r		0.10 to 0.99 / 0.01 / ±1.5 %R ±2 r
	1.0 to 49.9 / 0.1 / ±1.5 % ±r		1.0 to 49.9 / 0.1 / ±1.5 %R ±2r
	50.0 to 99.5 / 0.5 / ±2 % ±r		50.0 to 149 / 1 / ±2.5 %R ±2r
	100 to 199 / 1 / ±3 % ±r		150 to 245 / 5 / ±5 %R ±2r
	200 to 395 / 5 / ±5 % ±r		250 to 440 / 10 / ±10 %R ±2r
1,500-count display on CA 6416 / CA 6417	400 to 590 / 10 / ±10 % ±r		450 to 640 / 10 / ±15 %R ±2r
	600 to 1,150 / 50 / Approx. 20 %		650 to 1200 / 50 / ±20 %R ±2r
	1,200 to 1,500 / 50 / Approx. 25 %		
1,200-count display on CA 6418	Measurement frequency 2083 Hz		Measurement frequency
	Transposition frequency 50, 60, 128 or 2,083 Hz		≤ 4.5 mV at 2,083 Hz
Frequencies	Measurement ranges (μH) / Resolution (μH) / Accuracy		
	10 to 100 / 1 / ±5 % ±r		
Loop inductance measurement	100 to 500 / 1 / ±3 % ±r		
	Measurement ranges (V) / Resolution (V) / Accuracy		
Contact voltage (calculated)	0.1 to 4.9 / 0.1 / ±5 % ±r		
	5.0 to 49.5 / 0.5 / ±5 % ±r		
	50.0 to 75.0 / 1 / ±10 % ±r		
Ammeter	Measurement ranges (A) / Resolution (A) / Accuracy		
	0.200 to 0.999 mA / 1 μA / ±2 % ±50 μA		0.5 to 9.995 mA / 50 μA / ±2 %R ±200 μA
	1,000 to 2,990 mA - 3.00 to 9.99 mA / 10 μA / ±2 % ±50 μA		10.00 to 99.90 mA / 100 μA / ±2 %R ±r
	10.00 to 29.90 mA - 30.0 to 99.9 mA / 100 μA / ±2 % ±r		100.00 to 299.0 mA / 1 mA / ±2 %R ±r
	100.0 to 299.0 mA - 0.300 to 0.990 A / 1 mA / ±2 % ±r		0.300 to 2,990 A / 10 mA / ±2 %R ±r
	1,000 to 2,990 A - 3.00 to 39.99 A / 10 mA / ±2 % ±r		3.00 to 20.00 A / 100 mA / ±2 %R ±r
Setup			
Modes	Standard or advanced		Standard
Alarms	Configurable on Z, V and A		Configurable on Z, I
Buzzer	Active / Inactive		Active
HOLD	Manual or automatic PRE-HOLD		
Automatic power-off	Active / Inactive		
General specifications			
Display	152-segment OLED. Active area 48 x 39 mm		
Max. clamping diam.	∅ 35 mm		∅ 32 mm - L x H : 30 x 40 mm / 20 x 55 mm
Data storage	300 time-date-stamped measurements	2,000 time-date-stamped measurements	300 time-date-stamped measurements
Communication	Bluetooth Class 2		
Power supply	4 x 1.5 V LR06 batteries or 4 x NiMH batteries		
Battery life	1,440 measurements of 30 seconds each		2,440 measurements of 30 seconds each
Calibration	Automatic at startup		
Electrical safety	IEC 61010 600 V CAT IV		IEC 61010 100 V CAT IV, 150 V CAT III
Ingress protection	IP40		
Dimensions / weight	55 x 95 x 262 mm / Approx. 935 g with batteries		56 x 106 x 300 mm / Approx. 1.2 kg with batteries

⚙️ ACCESSORIES / REPLACEMENT PARTS

Bluetooth USB modem	P01102112
CL1 calibration loop	P01122301
See all the accessories on page 81	

CHOOSE YOUR ELECTRICAL EQUIPMENT TESTER



	CA 6161 page 64	CA 6163 page 64	CA 6165 page 65
Insulation			
50 V _{DC}			■
100 V _{DC} / 250 V _{DC} / 500 V _{DC} / 1,000 V _{DC}	■ (1 GΩ)	■ (50 GΩ)	■ (200 MΩ)
Dielectric tests			
40 to 3,000 V _{AC}	■	■	
40 to 5,350 V _{AC}		■	
100 to 5,000 V _{AC}			■ AC / DC
Continuity			
I test 0.1 A	■	■	
I test 0.2 A; 10 A	■	■	■
I test 25 A		■	■
I test 4 A			■
Voltage drop			
I test 10 A	■	■	■
Discharge time at 34 V / 60 V / 120 V			
Discharge time	■	■	■
Leakage current			
PE direct leakage method	■	■	■
Differential leakage method	■	■	■
Direct & differential method via clamp	■	■	
Substitution method		■	■
Contact leakage method		■	■
Functional test			
Active, reactive & apparent power values, voltage, current	■ (except reactive)	■ (except reactive)	■
THD U, THD I	■	■	■
Loop impedance and resistance			
Z _s -loop (L-PE) (Trip), Calculation of I _k (PFC)	■	■	
Z _s -loop (L-PE) (No Trip), Calculation of I _k (PFC)	■	■	
Z _i -loop (L-N or L-L), Calculation of I _{dc} (PSCC)	■	■	
RCD TEST			
PRCD x 0.5 / x1 / x5 x I _n	■	■	
RCD x 0.5 / x1 / x2 / x4 / x5 / x10 x I _n (AC, A, F, B, B+)	■	■	
Other functions			
Alarms	■	■	■
Phase sequence	■	■	
Data storage / Communication			
Data storage	■ 50,000 tests	■ 100,000 tests	■ μSD
Communication	USB	USB	RS232 / USB
Result sent to printer	■	■	■
Interfaces for START / STOP pedal and lamps	■	■	■
Interface for barcode	■ USB	■ USB	■ RS232 / USB
DOOR OPEN interface	■	■	■
PC software			
Automatic test sequences	■ MTT	■ MTT	■ MTLINK

CA 6161 - CA 6163

REF.: PO1145811

REF.: PO1145831

300 V
CAT IIIP
64Auto
ScriptNEXT
AVAILABLE

★ STRENGTHS

- Colour touch screen usable with insulating gloves
- Automatic test scripts
- Storage of up to 100,000 test
- Multilingual interface
- Dielectric test up to 3 kV / 5 kV, 25 A continuity, 1kV insulation
- Direct, differential, substitution and contact leakage current



+ ADDITIONAL INFO

- Functional tests
- Customizable visual inspections
- Direct connection for pedals, indicator lamps and barcode / RFID readers
- Direct automatic printing of Pass / Fail sticker

📦 CONTENTS

CA 6161 delivered with:

- 1 accessories bag containing:
- 2 High-Voltage test guns with cables (3 m)
- 2 cables with silicone insulation: 1 red, 1 black (3 m)
- 1 black test probe
- 1 three-point lead with separated wires (2.5 m)
- 1 three-point lead with Euro socket (2.5 m)
- 3 crocodile clips: blue, red and green
- 3 crocodile test probes: blue, red and green
- 1 bag containing 3 extension connectors
- 1 USB-A-USB-B cable
- 1 x C19 Euro mains power cable (2.5 m)

- 1 Quick Start Guide
- 1 product safety datasheet
- 1 test report with measurement list

CA 6161 with continuity accessories included:

- 2 x 10 A double continuity cables (2.5 m)
- 3 crocodile clips, 1 red, 2 black

CA 6163 with continuity accessories included:

- 1 x 25 A Kelvin gun (3 m)
- 1 x 25 A Kelvin crocodile clip (2.5 m)

⚙️ SPECIFICATIONS

	CA 6161	CA 6163	Socket test
High voltage			
AC / AC Ramp	40 – 3,000 V	40 – 5,350 V	
Resolution / accuracy	10 V / ±1 % R		
Max. current	200 mA		
I Measurement Range / accuracy	100 mA / 200 mA ±2 % R		
Insulation			■
Test voltage	100 V / 250 V / 500 V / 1,000 V		
Maximum measurement / accuracy	1,000 MΩ / ±10 % R	50 GΩ / ±10 % R	
Continuity			■
Measurement current	0.1 A; 0.2 A; 10 A (voltage drop)		
	-		25 A
Measurement range	20 Ω / 120 Ω; 2 Ω / 20 Ω / 60 Ω; 0.5 Ω	20 Ω / 120 Ω; 2 Ω / 20 Ω / 60 Ω; 0.5 Ω; 0.4 Ω	
Accuracy	±2 % R		
Leakage current			■
Direct I-PE- & I-differential Range / accuracy	Socket : 30 mA / ±2 % R Clamp: 40 A / ±2 % R		
I-substitution	-	Socket: 50 mA ±2 % R	
Contact leakage	-	Socket and three-point: 30 mA / ±(2 %R + 2 cts) measurement network: unweighted, weighted	
Loop / fuse table			
Zs No Trip (Zs & Rs) Range / Accuracy	2,000 Ω / ±5 % R / lk (display range) 20 kA		
ZS high current and Zi Range / Accuracy	400 Ω / ±5 % R / lk (display range) 20 kA		
Inductance Range / resolution / accuracy	15 mH / ±10 % R		
UF measurement	25.0 V / ±(15 %R + 3 cts); 70.0 V / ±(5 %R + 2 cts)		
RCD & PRCD Types AC, A, F, B; G, S			
Mains voltage & calibres	440 V _{AC} max; 10 / 30 / 100 / 300 / 500 / 1,000 mA / Var (6 – 1,000 mA)		
Pulse test	x 0.5; x 1; x 2, x 4; x 5; x 10 IΔn		
Trip time Range / accuracy	300 ms / ±(0 %R + 20 ct)		
Ramp test	10 / 30 / 100 / 300 / 500 / 1,000 mA; 0.3 x IΔn to 1.06 x IΔn in 22 steps		
Trip current Resolution / accuracy	0.1 mA; -0% + (7 %R + 2 mA)		
UF measurement	25.0 V / ±15 % R; 70.0 V / ±5 % R		
Discharge time at 34 V, 60 V, 120 V			■
Time / Up voltage	0.1 s – 9.9 s / 0.1 s / ±(1 %R + 1 ct); Socket & three-point: 34 V; 60 V; 120 V;		
Power values			■
Quantities	Socket: U, I, P, S, F, Pf, THD U, THD I		
Measurement range	265 V _{AC} ; 16 A; 4 kW; 7 kVA; 45-55 Hz; (-1,+1); 8.0 %; 100 %		
Quantities	Three-point + clamp: U, I, P, S, F, cos φ, Pf, THD U, THD I		
Measurement range	440 V _{AC} ; 16 A; 10.12 (1φ) / 30.36 (3 φ) kW; 10.12 (1φ) / 30.36 (3 φ) kVA; 45-55 Hz; (-1,+1); 100 %; 100 % / PF (-1,+1)		
Phase rotation			
Installation voltage and frequency	190 - 440 V; 45-55 Hz		
G72* current clamp			
Measurement range / accuracy	40 A / ±1 % R		
General specifications			
Display	Colour touch screen; TN 800 x 480, 5"		
Data storage	50,000 tests	100,000 tests	
Timer max.	40 min (depends on type of test)		
Communication	1 x USB-B; 2 x USB-A; Wifi		
Interfaces	START / STOP pedals, DOOR Open, HV gun trigger, 4 lamps, barcode reader, RFID reader, sticker printer		
Power supply	230 V _{AC} ; -15% + 10 %.		
Dimensions / weight	340 x 405 x 194 mm; 9kg (CA6161) / 15kg (CA6163)		
Temperature	Operation: 0; + 45 °C; Storage: - 40; + 60 °C		
Protection	IP 40 open / IP 64 closed		
Electrical safety	IEC 61010-1; IEC 61010-2-030; IEC 61010-2-034; 300 V CAT II; 300 V CAT III; 600 V CAT III; IEC 61010-2-032		
Standards	IEC 61557-1; -2; -3; -4; -6; -7; -10; -13; -14; -16 (part I)		

* optional

CA 6165

REF.: P01145851



★ STRENGTHS

- Capacitive colour touch screen
- Manual or automatic test sequences
- Storage of the tests on memory card up to 32 GB
- 5 kV_{AC} / 6 kV_{DC} HV dielectric, 25 A continuity, insulation at 1,000 V
- Substitute direct leakage current, PE, differential leakage current and touch leakage current

+ ADDITIONAL INFO

- External and internal discharge time up to 10 s / 550 V peak
- Functional test: P, Q, S, PF, Cos φ, THDU, THDI, U and I
- Inputs-outputs transmitted to pedal, indicator lamps, PC
- Compatible with 230 V / 115 V TT, TN or IT networks

📦 CONTENTS

CA 6165 delivered with:

- 1 accessories bag containing
- 2 high-voltage guns with cables (2 m)
- 2 test probes (red / black)
- 3 red crocodile clips, 2 black crocodile clips
- 1 RS232 cable
- 1 USB cable
- 1 EURO mains power cable
- 2 double continuity cables 2.5 m long
- 1 set of insulation cables 2.5 m long (red / black)
- 1 single continuity cable 1.5 m long (red)
- MTLINK PC software on CD-ROM
- 1 EURO discharge cable
- 1 multilingual safety datasheet
- 1 measurement report

⚙️ SPECIFICATIONS

		CA 6165			
High voltage					
AC / AC Programmable	Range	0 V to 1,999 V		2 kV to 5 kV	
	Resolution / Accuracy	1 V / ± 3 %R		10 V / ± 3 %R	
DC / DC Programmable	Range	0 V to 1,999 V		2 kV to 6 kV	
	Resolution / Accuracy	1 V / ± 3 %R		10 V / ± 3 %R	
Current	Range	AC: I apparent & resistive 0 mA to 99.9 mA I capacitive: -99.9 mA to +99.9 mA DC: 0.01 mA to 9.99 mA			
	Resolution / Accuracy	AC: I apparent: 0.1 mA / ± 3 %R ± 3 cts, indicative for I capacitive and I resistive DC: 0.01 mA / ± (5 %R + 3 cts)			
Continuity 0.2 A; 4 A; 10 A; 25 A, Voltage drop (10 A)					
	Range	0 to 19.99 Ω	20 to 99.9 Ω	100 to 199.9 Ω	200 to 999 Ω
	Resolution	0.01 Ω	0.1 Ω	0.1 Ω	1 Ω
	Accuracy	± (2 %R + 2 cts)	± 3 %R	± 5 %R	-
	Voltage drop (10 A)	0.00 V to 99.9 V			
Insulation					
	Voltage	50 V / 100 V		250 V / 500 V / 1,000 V	
	Range	0 to 19.99 MΩ	20 MΩ to 99.9 MΩ	0 to 19.99 MΩ	20 MΩ to 199.9 MΩ
	Resolution	0.01 MΩ	0.1 MΩ	0.01 MΩ	0.1 MΩ
	Accuracy	± (5 %R + 2 cts)	± 20 %R	± (3 %R + 2 cts)	± 10 %R
Leakage current					
	Method	Subs.	I PE	Diff.	Contact
	Range	0.00 to 19.99 mA	0.00 to 19.99 mA	0.00 to 19.99 mA	0.00 to 19.99 mA
	Resolution	10 μA	0.01 mA	0.01 mA	0.01 mA
	Accuracy	± (5 %R + 3 cts)	± (3 %R + 3 cts)	± (3 %R + 5 cts)	± (3 %R + 3 cts)
Discharge time at 34 V, 60 V, 120 V					
	Time	Range: 0 to 9.9 s	Res.: 0.1 s	Accuracy: ± (5 %R + 2 cts)	
	Up voltage	Range: 0 to 550 V	Res.: 1 V	Accuracy: ± (5 %R + 3 cts)	
Power values					
		Active (P)	App. (S)	Reactive (Q)	
	Range / resolution	0 to 3.70 kW / 0.01 W to 10 W	0 to 3.70 kVA / 0.01 VA to 10 VA	0 to 3.70 kVar / 0.01 VAr to 10 VAr	
	Accuracy	± (5 %R + 5 cts)	± (5 %R + 10 cts)	± (5 %R + 10 cts)	
	Others	PF, Cos φ, THDI, THDu; (5 %R + 5 D)			
	Voltage	0.0 V to 199 V / 0.1 V / ± (3 %R + 10 ct)		200 to 264 V / 1 V / ± 3 %R	
	Current	0 to 999 mA / 1 mA / ± (3 %R + 5 ct)		1.00 to 16.00 A / 10 mA / ± 3 %R	
General specifications					
	Display	TFT colour screen, 480 x 272 pixels			
	Data storage	On microSD card			
	Communication interfaces	RS232, USB, Bluetooth, Input / Outputs (2 x DB9)			
	Power supply	110 V / 230 V - 50 Hz / 60 Hz; Max. consumption: 600W / 4.5 kW if charged on mains test socket			
	Dimensions / weight	435 x 292 x 155 mm / 17 kg			
	Temperature	Operation: 0 °C to +40 °C; Storage: -10 °C to +60 °C			
	Protection	IP40 open / IP50 closed			
	Electrical safety	300 V CAT II / 600 V CAT II (DISCH1 / DISCH2)			

CHOOSE YOUR TESTER

MICRO-OHMMETERS



	CA 6240 page 69	CA 6255 page 69	CA 6292 page 70
4-wire measurement method (Kelvin)	■	■	■
Measurement range	400 Ω	2,500 Ω	1 Ω
Resolution	1 μΩ	0.1 μΩ	0.1 μΩ
Measurement current	10 A / 1 A / 100 mA / 10 mA	10 A / 1 A / 100 mA / 10 mA / 1 mA	Automatic 50 / 100 / 150 and 200 A Manual from 20 to 200 A
Inductive mode	Normal	Inductive, non-inductive, non-inductive auto	Normal / BSG = Both Sides Grounded
Alarms		■	
Temperature compensation		■	
Communication USB / RS232	■		■
Data storage (measurements)	100	1500	8000
Automatic recording	■		■
Power supply	NiMH rechargeable batteries	NiMH rechargeable batteries	Mains

RATIOMETERS



	DTR 8510 page 71
Range of VT / PT ratios	0.8000 to 8,000 / 1
Range of CT ratios	0.8000 to 1,000 / 1
Battery life	up to 10 hours
Data storage	10,000 tests
Communication	Optical USB

PHASE ROTATION AND / OR MOTOR TESTERS



	CA 6608 page 72	CA 6609 page 72
Operating mode	With connection	With and without connection
Operating voltage with connection	40 to 850 V _{AC} between phases	40 to 600 V _{AC} between phases
Operating voltage without connection		120 to 400 V _{AC} between phases
Power supply	By the measurement	9 V battery

CABLE AND METAL CONDUCTOR LOCATOR



	CA 6681 E / R page 73
Operation with / without voltage	■
Location of a short-circuit / circuit break	■
Location of cables, conductors or metal pipes	■

BATTERY CAPACITY TESTERS



	CA 6630 page 72
Measurement range min / max	40 mΩ / 40 Ω
Resolution min / max	10 μΩ / 10 mΩ
Measurement frequency	1 kHz
Comparison function	99 sets of settings
Manual data storage (no. of locations)	999
Automatic data storage (no. of locations)	9,600

CA 6240

REF.: P01143200

50 V
CAT III

IP
53



★ STRENGTHS

- 4-wire measurement method
- Automatic current reversal
- Test current up to 10 A
- 1 $\mu\Omega$ resolution
- Automatic recording "on the fly" or manual recording

⚙️ SPECIFICATIONS

		CA 6240					
Measurement method	4-wire method						
Range	4,000 $\mu\Omega$	40 m Ω	400 m Ω	4,000 m Ω	40 Ω	400 Ω	
Accuracy	0.25 % ± 2 cts	0.25 % ± 2 cts	0.25 % ± 2 cts	0.25 % ± 2 cts	0.25 % ± 2 cts	0.25 % ± 2 cts	
Resolution	1 $\mu\Omega$	10 $\mu\Omega$	0.1 m Ω	1 m Ω	10 m Ω	100 m Ω	
Measurement current	10 A	1 A	1 A	100 mA	10 mA	10 mA	
Data storage	100 measurements						
Communication output	Optical link / USB						
Power supply	NiMH rechargeable battery						
Dimensions / weight	273 x 247 x 280 mm / 5 kg						
Electrical safety	IEC 61010 - 50 V CAT III						

+ ADDITIONAL INFO

- The CA 6240 is compatible with the DataView® software

📦 CONTENTS

- CA 6240 delivered with:
- 1 shoulder bag
 - 1 set of 2 x 10 A Kelvin clamps with 3 m cable
 - 1 European 2P mains power cable
 - Data export software
 - 1 optical / USB communication cable

⚙️ ACCESSORIES / REPLACEMENT PARTS

Double 1 A test probes (x 2)	P01102056
Mini Kelvin clamp (set of 2)	P01101783
See all the accessories on page 82	

CA 6255

REF.: P01143221

50 V
CAT III

IP
53



★ STRENGTHS

- Optimized measurement on inductive objects
- 4-wire measurement method
- Automatic compensation of stray currents
- Test current of up to 10 A
- Measurements up to 2,500 Ω , resolution 0.1 $\mu\Omega$
- Integrated "temperature compensation" function

⚙️ SPECIFICATIONS

		CA 6255						
Measurement method	4-wire method							
Range	5,000 m Ω	25,000 m Ω	250.00 m Ω	2,500.0 m Ω	25,000 Ω	250.00 Ω	2,500.0 Ω	
Accuracy	0.05 % $+1 \Omega$	0.05 % $+3 \mu\Omega$	0.05 % $+30 \mu\Omega$	0.05 % $+0.3 m\Omega$	0.05 % $+3 m\Omega$	0.05 % $+30 m\Omega$	0.05 % $+300 m\Omega$	
Resolution	0.1 $\mu\Omega$	1 $\mu\Omega$	10 $\mu\Omega$	0.1 m Ω	1 m Ω	10 m Ω	100 m Ω	
Measurement current	10 A	10 A	10 A	1 A	100 mA	10 mA	1 mA	
Measurement mode	Inductive, non-inductive, non-inductive with automatic trigger							
Temperature compensation	By temperature sensor or manual							
Data storage	1,500 measurements							
Communication output	RS232 link							
Power supply	NiMH rechargeable battery							
Dimensions	270 x 250 x 180 mm / 4 kg							
Electrical safety	IEC 61010 - CAT III 50 V							

+ ADDITIONAL INFO

- The CA 6255 is compatible with the DataView® software
- Possibility of connecting the Pt100 sensor (option) directly to the instrument

📦 CONTENTS

- CA 6255 delivered with a bag containing:
- 1 set of cables 3 m long terminated by Kelvin clamps
 - 1 Euro mains power cable 2 m long
 - 1 CD-ROM containing the MOT (Micro-Ohmmeter Transfer) software
 - 1 RS 232 communication cable
 - 1 CD-ROM containing the user's manual in 9 languages

⚙️ ACCESSORIES / REPLACEMENT PARTS

Doubles 1 A test probes (x 2)	P01102056
Mini Kelvin clamp (set of 2)	P01101783
See all the accessories on page 82	

CA 6292

REF.: P01143300

IP
54Diagnostics
& inspection

Education

Energy
efficiency

Transport

Energy
& renewable

Industries

Generation,
transmission
& distributionLaboratory
& research

★ STRENGTHS

- Permanent test at 100 A and for up to 120 s at 200 A
- Test current up to 200 A
- Resistance from 0.1 $\mu\Omega$ to 1 Ω
- Safe measurements: BSG method (Both Sides Grounded)
- Storage of up to 8,000 measurement results

⚙️ SPECIFICATIONS

	CA 6292
Test current	Programmable from 20 to 200 A
Resistance	0.1 $\mu\Omega$ to 2 m Ω 2 to 200 m Ω 200 m Ω to 1 Ω
Resolution	0.1 $\mu\Omega$ (200 A max) 10 $\mu\Omega$ (25 A max at 200 m Ω) 1 m Ω (5 A max at 1 Ω)
Accuracy	$\pm 1\%$ from 50 $\mu\Omega$ to 1 Ω
Output voltage	110 V _{AC} : 4.2 V @ 200 A 220 V _{AC} : 8.6 V @ 200 A
Maximum load resistance	110 V _{AC} : 20 m Ω @ 200 A 220 V _{AC} : 42 m Ω @ 200 A
Measurement method	4 Kelvin-type connection terminals
Test mode	Normal or Both Sides Grounded (BSG)
Test duration	Adjustable from 5 to 120s @ 200 A Unlimited below 100 A
Data storage	Up to 8,000 measurement results
Interface	USB 2.0
Software	DataView®
Power supply	100 to 240 V _{AC} - 50 / 60 Hz
Dimensions	502 x 394 x 190 mm
Weight	Approx. 13 kg
Operating temperature	0 °C to +55 °C
Storage temperature	-10 °C to +70 °C
Humidity	95% RH
Protection	Protected against voltage surges, short-circuits, overheating and overvoltage on the safety terminals
Ingress protection	IP54
Electrical safety	IEC 61010-1
Consumption	1,500 VA max
Current measurement with the MR6292 clamp available as an option	
Measurement range	1.0 – 50.0 A _{DC}
Resolution	0.1 mA
Intrinsic uncertainty	$\pm (1.5\% + 2 \text{ cts})$
Output signal	10 mV / A _{DC}
Load impedance	> 100 k Ω // 100 pF
Influence of conductor position in jaws	0.50 %

⚙️ ACCESSORIES / REPLACEMENT PARTS

1 set of 2 Kelvin leads 6 m long (red / black) adjustable-clamp connections	P01295486
1 green earth lead with crocodile clip	P01295488
See all the accessories on page 82	

+ ADDITIONAL INFO

- The backlit LCD screen with its 4 lines of 20 characters is easy to read whatever the environment.

📦 CONTENTS

CA 6292 delivered with a hard case containing:

- 1 set of 2 Kelvin leads 6 m long (red / black) with adjustable-clamp connections
- 1 green earth lead 3 m long with 1 crocodile clip
- 1 USB cable 1.5 m long
- 1 T1 5 A 250 V fuse mounted in the instrument
- 1 European mains power lead
- 1 CD-ROM containing the DataView® software
- 1 CD-ROM containing the user manual in 5 languages

DTR 8510

REF.: P01157702

50 V
CAT IVIP
53Diagnostics
& inspection

Education

Energy
efficiency

Transport

Energy
& environment

Industries

Generation,
transmission
& distributionLaboratory
& research

ADDITIONAL INFO

- Up to 10 hours' continuous operation thanks to the rechargeable NiMH batteries



CONTENTS

DTR 8510

- 1 shoulder bag
- 1 set of leads 4.6 m long with crocodile clips
- 1 external battery charger with mains lead
- 1 USB cable
- 1 NiMH battery datasheet
- DataView software on CD-Rom



ACCESSORIES / REPLACEMENT PARTS

Set of 2 cables 4.6 m long	P01295143A
USB lead	P01295293

See all the accessories on page 82

STRENGTHS

- Measurement of the transformation ratio of power, voltage and current transformers
- Storage of up to 10,000 measurement results
- Displays the transformation ratio, the excitation current, the winding polarity and the percentage deviation from the rated values
- Direct reading of the transformation ratio from 0.8000:1 and up to 8000.0:1
- Tests performed by excitation of the primary with measurement on the secondary

SPECIFICATIONS

	DTR 8510										
Range of ratios (TT / TP)	Automatic: 0.8000 to 8,000:1										
Accuracy (VT / PT)	<table border="1"> <thead> <tr> <th>Range of ratios</th> <th>Accuracy (% of reading)</th> </tr> </thead> <tbody> <tr> <td>0.8000 to 9.9999</td> <td>± 0.2 %</td> </tr> <tr> <td>10.000 to 999.99</td> <td>± 0.1 %</td> </tr> <tr> <td>1,000.0 to 4,999.9</td> <td>± 0.2 %</td> </tr> <tr> <td>5,000.0 to 8,000.0</td> <td>± 0.25 %</td> </tr> </tbody> </table>	Range of ratios	Accuracy (% of reading)	0.8000 to 9.9999	± 0.2 %	10.000 to 999.99	± 0.1 %	1,000.0 to 4,999.9	± 0.2 %	5,000.0 to 8,000.0	± 0.25 %
Range of ratios	Accuracy (% of reading)										
0.8000 to 9.9999	± 0.2 %										
10.000 to 999.99	± 0.1 %										
1,000.0 to 4,999.9	± 0.2 %										
5,000.0 to 8,000.0	± 0.25 %										
Range of ratios (CT)	Automatic range: 0.8000 to 1,000.0 ± 0.5 %R										
Accuracy (CT)	± 0.5 %L										
Excitation signal	VT / PT mode: 32 V _{RMS} max. CT mode: auto level 0 to 1 A, 0.1 to 4.5 V _{RMS}										
Display of excitation current	Range: 0 to 1,000 mA; Accuracy: ± (2 %R + 2 mA)										
Excitation frequency	70 Hz										
Display	Alphanumeric LCD, 2 lines of 16 characters with adjustment of the contrast and backlighting. Easy to read in both day and night conditions										
Available languages	French, English, Spanish, Italian, German, Portuguese										
Measurement method	As per the IEEE Std C57.12.90™ standard										
Power supply	2 x 12 V, NiMH rechargeable batteries, 1,650 mAh										
Battery life	Up to 10 hours in continuous operation, low battery alert										
Battery charger	Universal input (90 to 264 V _{RMS}), smart charger										
Charging time	< 4 hours for full charge										
Data storage	10,000 tests										
Date / time	Power supply by dedicated battery, real-time clock										
Communication	USB 2.0, optical isolation, 115.2 kB										
Software	Delivered with the DataView® analysis software										
Dimensions / weight	272 x 248 x 130 mm / 3.7 kg										
Connection	XLR connectors										
Cables	Screened H and X cables, length 4.6 m (15 ft), equipped with colour-coded crocodile clips										
Casing	Rugged polypropylene casing, UL 90 VO										
Vibrations	IEC 68-2-6 (1.5 mm at 55 Hz)										
Shocks	IEC 68-2-27 (30 G)										
Falls	IEC 68-2-32 (1 m)										
Ingress protection	IP 40 with lid open as per EN 60529 IP 53 with lid closed as per EN 60529										
Safety	EN 61010-1, 50 V CAT IV; pollution degree 2										

CA 6608 - CA 6609

REF.: PO1191304

REF.: PO1191305

**600 V
CAT III****IP
40****PHASE ROTATION
AND / OR MOTOR TESTERS****★ STRENGTHS**

- Indication of phase presence or absence
- Determination of a motor's rotation direction with or without contact (CA 6609 only)
- Automatic tests as soon as the connections have been set up
- Terminals and cables identified by colour coding to simplify connection

⚙️ SPECIFICATIONS

	CA 6608	CA 6609
Operating voltage according to phase rotation	40 to 850 V _{AC} between phases	With connections: 40 to 600 V _{AC} between phases Without connection: 120 to 400 V _{AC} between phases
Frequency range	15 to 400 Hz	
Power supply	Self-powered via the measurement inputs	9 V battery
Dimensions	130 x 69 x 32 mm	
Weight	130 g	170 g
Electrical safety	IEC 61010-1 600 V CAT III IEC 61557-7	

📦 CONTENTS

CA 6608 phase rotation testers delivered in a shoulder bag with:

- 3 test leads
- 3 crocodile clips

CA 6609 phase rotation and motor tester delivered in a shoulder bag with:

- 3 test leads
- 3 crocodile clips

CA 6630

REF.: PO1191303

**BATTERY CAPACITY
TESTERS****★ STRENGTHS**

- Zero adjustment function for compensation of the voltage circuit displayed
- 2-display LCD screen
- 7-hour battery life in continuous operation with 6 x 1.5 V batteries (not supplied)
- Capacity test from 35 Ah to 500 Ah
- Nickel-Cadmium, Lithium-Ion, Nickel-Metal-Hybrid or Lead-Acid batteries

⚙️ SPECIFICATIONS

	CA 6630			
Resistance measurement				
Range	40 mΩ	400 mΩ	4 Ω	40 Ω
Resolution	10 μΩ	100 μΩ	1 mΩ	10 mΩ
Measurement current	37.5 mA	3.75 mA	375 A	37.5 A
Accuracy	± (1 %R + 8 digits) Temp. coeff.: ± (0.1 %R + 0.5 digit) / °C			
Measurement	1.5 mV _{AC}			
Measurement frequency	1 kHz ± 10 %			
Voltage measurement				
Range	4 V		40 V	
Resolution	1 mV		10 mV	
Accuracy	± (0.1 %R + 6 digits)			
Max. consumed power	1 VA			
Mechanical specifications				
Dimensions	250 x 100 x 45 mm			
Weight	500 g batteries included			

📦 CONTENTS

1 hard case containing:

- **CA 6630**
- 1 set of 2 measurement leads 1 m long terminated by retractable test probes
- PC data transfer software to export and process the stored data
- 1 CA 6630 / PC connection cable

⚙️ ACCESSORIES / REPLACEMENT PARTS

Set of 2 leads with retractable test probes
See all the accessories on page 82

P01102103

CA 6681

REF.: P01141626



CONTENTS

- 1 hard case containing
 - 1 **CA 6681E** transmitter
 - 1 **CA 6681R** receiver
 - 1 set of 2 red / black leads, straight male isolated \varnothing 4 mm banana / elbowed male isolated \varnothing 4 mm banana, 1.5 m long
 - 1 set of 2 red / black crocodile clips
 - 1 earthing stake
 - 1 adapter for mains power socket
 - 1 male plug adapter for B22 bayonet socket
 - 1 male plug adapter for E27 screw socket
 - 1 x 9 V 6LR61 battery
 - 6 x 1.5 V LR03 batteries

STRENGTHS

- Can be used on live or non-current-carrying installations
- Digital, visual and audible indication to track the conductor intuitively
- Large LCD screen with indication of the transmission power, the digital identification code and the voltage present on the circuit tested.

SPECIFICATIONS

	CA 6681 E
Frequency of signal emitted	125 kHz
External voltage measurement	12~300 V _{DC} / AC (50~60 Hz)
Dimensions	190 × 89 × 42.5 mm
Weight	Approx. 420 g with battery

	CA 6681 R
Detection depth	Single-pole application: 0 to 2 m approx. Two-pole application: 0 to 0.5 m approx. Simple looping line: up to 2.5 m
Identification of mains voltage	0~0.4 m approx.
Dimensions	241.5 × 78 × 38.5 mm
Weight	360 g approx. with battery

ADDITIONAL INFO

- Automatic or manual adjustment of signal reception sensitivity
- The transmitter and receiver units are equipped with:
 - A battery status indicator
 - An additional lighting system (torch) for use in dark environments

ACCESSORIES / REPLACEMENT PARTS

33 m reel of green wire with battery clip / 4 mm male banana on winder with handle

P01295268

See all the accessories on page 82

DATAVIEW®

REF.: PO1102095

ICT

MEG

GTT

GTC

MOT

DTR

MTT



ICT REPORTS ACCORDING TO THE APPLICABLE STANDARDS

The ICT module of DataView® proposes to define the tree-structure which will be used during the actual test campaign (sites, parts, objects), as well as the tests to be performed for each of them. Once defined in this way, the campaign can be recorded in the instrument via the communication link. This saves significant time in the field.

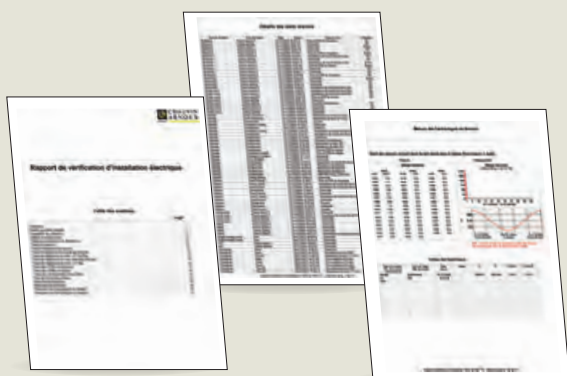

FUNCTIONS

- Configuration of all the functions of instruments connected to a PC or via Bluetooth
- Recovery of the recorded measurement data
- Backup of measurement files
- Opening of saved files
- Processing and creation of reports
- Export into an Excel spreadsheet
- Export in .pdf format
- Database management
- Remote test activation by simply pressing a button
- Data capture and display in real time
- Display of DAR, PI and DD ratios
- Graphical plotting of programmed-duration tests and voltage ramp tests in real time
- Possibility of creating a library of configurations for specific applications
- Printing of measurement reports

REQUIRED CONFIGURATION

- Windows Vista & Windows 7 / 8 / 10 (32 / 64 bit)
- 1 GB RAM for Windows Vista & Windows 7 / 8 (32 bit)
- 2 GB RAM for Windows Vista & Windows 7 / 8 (64 bit)
- 80 MB disk space available (200 MB recommended)

ADDITIONAL INFO

- The DataView® software:
- Automatically recognizes the instrument connected when it is hooked up to the PC and opens the corresponding menu. Users then have direct access to the configuration and the recorded data
- Is equipped with a large number of predefined report templates for quick generation in compliance with the applicable standards. Users can also create their own templates, as required, and directly add their own comments.

DataView® modules	ICT	MEG	GTT	GTC	MOT	DTR	MTT*
	CA 6116N	CA 6543	CA 6470N	CA 6417	CA 6240	DTR 8510	CA 6161
	CA 6117	CA 6547	CA 6471		CA 6255		CA 6163
		CA 6549	CA 6472		CA 6292		
Related products		CA 6550	CA 6474				
		CA 6555					
		CA 6526					
		CA 6532					
	CA 6534						

* available soon

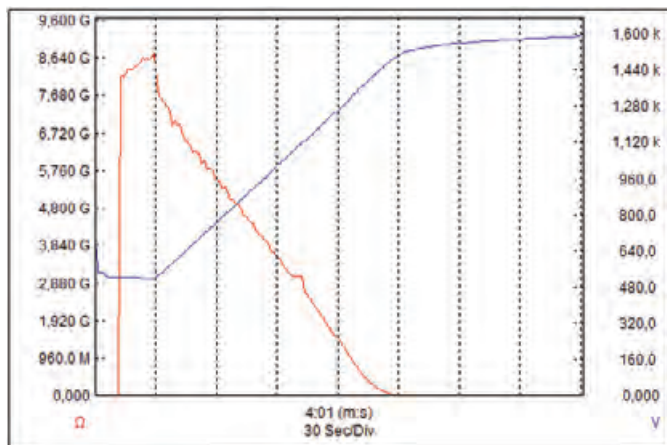

MODULE MEG Graphical plotting of the V(t) and R(t) tests on non-linear insulation resistance

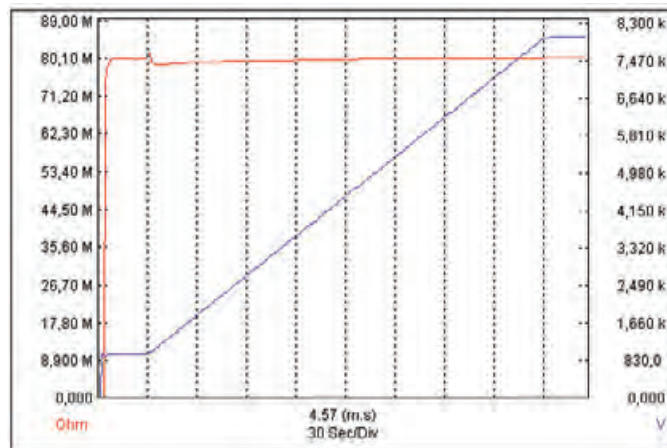

MODULE MEG Graphical plotting of the V(t) and R(t) tests on fixed insulation resistance (surge suppressor)

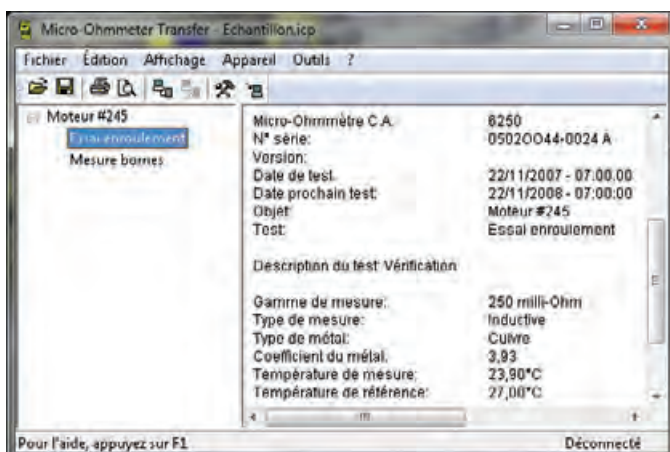

MOT MODE Results of motor winding test

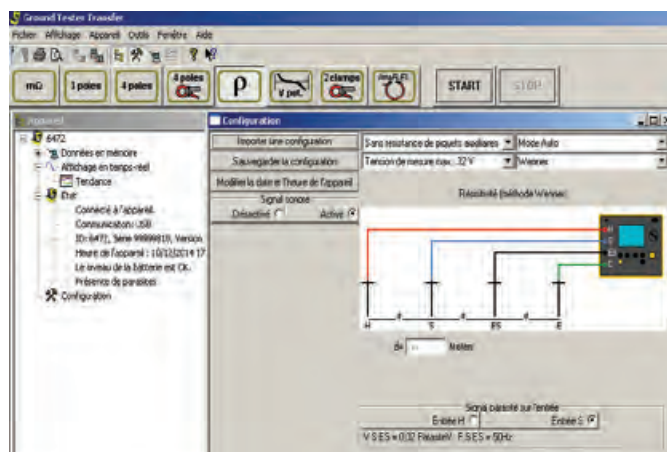

GTT MODULE Example of configuration

Date de test	Test	Type de test	Filtre	Rapport de tra	Caractérisation	Courant	Primaire	Secondaire
28/01/2011 - 14:37:35	Test 1	TC	Normal	1,0006:1	N/A	0 mA	19920 A	7200 A
28/01/2011 - 14:38:05	Test 2	TC	Normal	2,4999:1	N/A	0 mA	19920 A	7200 A
28/01/2011 - 14:38:32	Test 3	TC	Normal	24,998:1	N/A	0 mA	19920 A	7200 A
20/01/2011 - 14:39:14	Test 4	TC	Normal	90,900:1	N/A	0 mA	19920 A	7200 A
28/01/2011 - 14:39:44	Test 5	TC	Normal	908,99:1	N/A	0 mA	19920 A	7200 A
28/01/2011 - 14:40:56	Test 6	TT/TP	Normal	1,0007:1	N/A	125 mA	19920 V	7200 V
28/01/2011 - 14:41:38	Test 7	TT/TP	Normal	1,0007:1	N/A	0 mA	19920 V	7200 V
28/01/2011 - 14:42:06	Test 8	TT/TP	Normal	4,9988:1	N/A	0 mA	19920 V	7200 V
28/01/2011 - 14:42:30	Test 9	TT/TP	Normal	24,998:1	N/A	0 mA	19920 V	7200 V
20/01/2011 - 14:42:51	Test 10	TT/TP	Normal	90,900:1	N/A	0 mA	19920 V	7200 V
28/01/2011 - 14:43:13	Test 11	TT/TP	Normal	909,02:1	N/A	1 mA	19920 V	7200 V
28/01/2011 - 14:43:58	Test 12	TT/TP	Normal	2498,5:1	N/A	0 mA	19920 V	7200 V
28/01/2011 - 14:44:18	Test 13	TT/TP	Normal	5007,5:1	N/A	1 mA	19920 V	7200 V
28/01/2011 - 14:44:40	Test 14	TT/TP	Normal	8337,7:1	N/A	1 mA	19920 V	7200 V

DTR MODULE Recovery of the measurement data recorded in the ratiometer

ACCESSORIES FOR MULTIFUNCTION INSTALLATION TESTERS

■ Accessories ■ Included in the initial delivery

	Article code	Description	CA 6113	CA 6116N	CA 6117	CA 6131	CA 6133
MEASUREMENT LEADS AND SENSORS	 P01295398	2.5 m three-point lead with separate wires	■	■	■		
	 HX0300	Three-point Euro cable				■	■
	 P01295393	Three-point cable for EURO mains socket test	■	■	■		
	 P01295094	2 elbowed-straight safety leads - (red and black) 3 m long	■	■	■		
	 P01101921	3 x Ø 4 mm test probes - (red, blue and green)	■	■	■		
	 P01101922	3 crocodile clips (red, blue and green)	■	■	■		
	 P01102092A	CA 6116N remote-control probe	■	■	■		
	 P01102157	CA 6131 - CA 6133 remote-control probe				■	■
	 P01101943	Spare black test probe for remote-control probe	■	■	■		
	 P01120335	C177 clamp (20 A)	■				
	 P01120336	C177A clamp (200 A)	■	■	■		
	 P01120460	MN77 clamp (20 A)	■	■	■		
	 P01120439	MN73A clamp					■
	 P01120421	MN73 clamp				■	
	POWER SUPPLY / BATTERIES	 P01102057	PA 30 W mains power pack	■			
 P01102129		Type-2 power pack / charger without mains lead (requires P01295174)		■	■	■	■
 P01296024		NIMH 4AH battery pack	■				
 P01296047		Li-Ion battery pack		■	■	■	■
 P01102130		Li-Ion charging support without mains lead		■	■	■	■
 P01295174		EURO 2P mains lead	■	■	■	■	■
 HX0061		DC / DC vehicle cigarette-lighter charger	■				
 P01102186	Type-R USB charger					■	
MISCELLANEOUS	 P01102084A	Continuity rod	■	■	■	■	■
	 P01102017	15 m earth kit (red / blue / green)	■	■	■	■	■
	 P01102018	Black 30 m 1P earth kit	■	■	■		
	 P01102021	3P earth kit (50 m)	■	■	■		
	 P01102022	3P earth kit (100 m)	■	■	■		
	 P01298081	4-point hands-free strap (Model 2)	■	■	■		
	 P01298057	Hand strap	■	■	■		
	 P01102094	CA 6116 screen protection film	■	■	■		
	 P01298056	Carrying bag no. 22	■	■	■		
	 P01295293	USB-A USB-B lead	■	■	■		
	 P01102095	DataView® software		■	■		
	 P01298082	Comfort strap	■	■	■		
 HX0302	4-point strap				■	■	

MEASUREMENT LEADS FOR INSULATION TESTERS

■ Accessories ■ Included in the initial delivery

	Article code	Description	Length	CA 6505	CA 6545	CA 6547	CA 6549	CA 6550	CA 6555
5 KV RANGE		P01295231	Red simplified HV safety lead / black with rear connection	3 m	■	■	■	■	
		P01295232	Blue simplified HV safety lead + blue crocodile clip	3 m	■	■	■	■	
		P01295516	Blue guarded HV safety lead with rear connection	0.35 m	■	■	■	■	
		P01295510 + P01295506 + P01295513	Set of 3 safety leads with HV crocodile clip (red / blue / black)	3 m	■	■	■	■	
		P01295507	Safety lead with blue HV crocodile clip	8 m	■	■	■	■	
		P01295511	Safety lead with red HV crocodile clip	8 m	■	■	■	■	
		P01295514	Safety lead with rear connection and black HV crocodile clip	8 m	■	■	■	■	
		P01295508	Safety lead with blue HV crocodile clip	15 m	■	■	■	■	
		P01295512	Safety lead with red HV crocodile clip	15 m	■	■	■	■	
		P01295515	Safety lead with rear connection and black HV crocodile clip	15 m	■	■	■	■	
10 / 15 KV RANGE		P01295465	Set of 3 red, blue and black simplified HV safety leads with rear connection	3 m				■	■
		P01295517 + P01295520 + P01295523	Set of 3 safety leads with red / blue / black HV crocodile clip with rear connection	3 m				■	■
		P01295526	Blue guarded HV safety lead with rear connection	0.5 m				■	■
		P01295521	Safety lead with blue HV safety lead	8 m				■	■
		P01295518	Safety lead with red HV crocodile clip	8 m				■	■
		P01295524	Safety lead with rear connection and black HV crocodile clip	8 m				■	■
		P01295522	Safety lead with blue HV crocodile clip	15 m				■	■
		P01295519	Safety lead with red HV crocodile clip	15 m				■	■
	P01295525	Safety lead with rear connection and black HV crocodile clip	15 m				■	■	

CONTENTS OF THE EARTH AND RESISTIVITY KITS

To order		Contents of the earth and resistivity kits							Recommended related products								
Article code	Description	Reels and winders				Other accessories			Installation testers		3P	3 / 4P+ρ	Expert			Pylon	
		Green	Red	Blue	Black	Stake(s) / mallet	Spade lug / banana adapter	Carrying bag	CA 6113	CA 6116N CA 6117	CA 6422 CA 6424	CA 6460 CA 6462	CA 6470N	CA 6471	CA 6472	CA 6474	
1P kit	P01102018	Black 30 m 1P earth kit						33 m	1 / -								
	P01102020	33 m 1P loop kit ³				33 m			1 / -								
3P kit	P01102017	15 m 3P earth kit (red / green / blue)				5 m	15 m	10 m	2 / -								
	P01102021	50 m earth kit for 3P method				10 m	50 m	50 m	2 / 1	5	Standard						
	P01102022	100 m earth kit for 3P method				10 m	100 m	100 m	2 / 1	5	Standard						
4P kit	P01102023	166 m earth kit for 3P method				10 m	166 m	166 m	2 / 1	5	Prestige						
	P01102040	50 m 4P earth & resistivity kit				33 m	50 m	50 m	33 m	4 / 1	5	Standard					
	P01102024	100 m earth & resistivity kit				100 m 10 m	100 m	100 m	33 m	4 / 1	5	Prestige					
	P01102025	166 m earth & resistivity kit				100 m 10 m	166 m	166 m	33 m	4 / 1	5	Prestige					
Comp.	P01102030	100 m add-on for resistivity				100 m				2 / -							

OTHER ACCESSORIES

Article code	Description	Reels and winders			
		Green	Red	Blue	Black
P01102026	Green cable H winder ¹	10 m			
P01102028	Set of 4 adapters for terminals ³				
P01102029	Set of 4 reel handles				
P01102031	T-shaped earth stake				
P01102046	Set of 3 adjustable clamps				
P01102047	H-shaped black cable winder - 10 m ¹				10 m
P01120310	C172 clamp				
P01295260	166 m red cable reel ¹		166 m		
P01295261	100 m red cable reel ¹		100 m		
P01295262	50 m red cable reel ¹		50 m		
P01295263	166 m blue cable reel ¹			166 m	
P01295264	100 m blue cable reel ¹			100 m	
P01295265	50 m blue cable reel ¹			50 m	
P01295266	100 m green cable reel ¹	100 m			
P01295267	33 m black cable reel ¹				33 m
P01295268	33 m green cable reel ¹	33 m			
P01295270	2 m black cable winder (2 m cable for clamps) ¹				2 m*
P01295291	5 m green cable H winder ²	5 m			
P01295292	5 m black cable H winder ²				5 m

¹ connections: spring clip - banana

² connections: banana - banana

³ for CA 6030

* for CA 6470N and CA 6471

Article code	Description															
P01102037	CA 647x continuity kit (4 red, black, blue and yellow crocodile clips), (2 black test probes), (4 red, black, blue and yellow cables 1.5 m long)															
P01120550	5 m AmpFlex™ flexible current sensors															
P01120551	8 m AmpFlex™ flexible current sensors															
P01102046	Set of 3 adjustable clamps															
P01120310	C172 clamp ³															
P01120335	C177 clamp															
P01120336	C177A clamp															
P01120333	C182 clamp															
P01120872	G72 clamp															

+ **ADDITIONAL INFO**













Possibility of ordering carrying bag:

- Standard version P01298066
- Prestige version P01298067



ACCESSORIES FOR ELECTRICAL EQUIPMENT TESTERS

■ Accessories ■ Included in the original delivery

	Article code	Description	Length	CA 6161	CA 6163	CA 6121	CA 6155	CA 6160	CA 6165
Test and measurement lead									
	P01295097	4 mm banana cable- red + black	3 m			■		■	■
	P01295137	Double crocodile cable – black	2.5 m			■			
	P01295140	Double crocodile cable – red	2.5 m			■			
	P01295141	Discharge cable (EURO)	2 m			■		■	■
	P01295236	Double continuity cables	2.5 m					■	■
	P01295234	Power cable (EURO)	2 m					■	
	P01102139	Red test lead	4 m				■		
	P01102136	Plug-in test cable	1.5 m				■		
	P01102137	Test cable with separate wires	3 m				■		
	P01102138	Black + red test lead	1.5 m				■		
	P01102140	Green test lead	1.5 m				■		
	P01102141	Black test probe for CA 6155					■		
	P01102142	Red test probe for CA 6155					■		
	P01102143	Green test probe for CA 6155					■		
	P01102144	Blue test probe for CA 6155					■		
	P01102145	Set of 3 black crocodile clips					■		
HV test gun and probe									
	P01101919	HV test gun	2 m			■		■	■
	P01102135	HV test probe for CA 6155, for P01146001					■		
	P01102193	Set of 2 HV test guns - 3 m		■	■				
	P01102195	Set of 2 HV test guns - 15 m		■	■				
	P01101918	HV test gun	6 m			■		■	■
	P01102182	HV test gun (set of 2)	2 m						■
Remote control, indication and communication									
	P01101916	Remote-control pedals				■		■	
	P01101917	Red / green indicator lamps				■		■	
	P01102191	Remote-control pedal -3		■	■				
	P01102192	4-lamp tower - 2		■	■				
	P01101841	DB9F-DB25M adapter				■		■	
	P01295172	DB9F-25F cable x2				■		■	
	P01295173	DB9F-DB9M cable no. 1				■			
	P01102177	Control pedal							■
	P01102178	2-colour indicator lamp							■
	P01102179	4-colour indicator lamp							■
	P01102180	Power supply adapter for lamps							■
	P01101915	MachineLink software with communication cables				■			
		CALink software					■		
		MTLink software							■
	P01101996	CELink software with communication cables						■	
Fuses									
	P01297086	F 6x32T 16 A 250 V (set of 10 fuses)					■	■	
	P01297102	F 6x32T 16 A 500 V (set of 10 fuses)					■		■
	P01297103	F 5x20T 5 A 250 V (set of 10 fuses)					■		■

ACCESSORIES FOR OTHER TESTERS

■ Accessories ■ Included in the original delivery

	Article code	Description	Connections	CA 6161	CA 6163	CA 6240	CA 6255	CA 6292	DTR 8510	CA 6681	CA 6630
Double test probes and Kelvin clamps for micro-ohmmeters											
	P01101794	10 A Kelvin clamps (set of 2), L=3 m	Spade lug			■	■				
	P01101783	1 A Kelvin mini-clamps (set of 2)	Spade lug			■	■				
	P01102056	1 A double test probe (set of 2) L=2.85 m	Spade lug and 4 mm banana			■	■				
	P01103065	10 A double gun-type test probe (set of 2) L= 3.15 m	Spade lug and 4 mm banana			■	■				
	P01103063	10 A double pivoting test probe (set of 2) L= 3.15 m	Spade lug and 4 mm banana			■	■				
	P01295486	Set of 2 Kelvin leads 6 m long (red / black) with adjustable-clamp connections						■			
	P01295487	Set of 2 Kelvin leads 15 m long (red / black) with adjustable-clamp connections						■			
	P01295494	Set of 2 leads 6 m long with 200 A Kelvin clamps						■			
	P01295495	Set of 2 leads 15 m long with 200 A Kelvin clamps						■			
	P01101784	1 x 25 A Kelvin crocodile clip		■	■						
	P01102199	1 x 25 A Kelvin test probe 3 m long		■	■						
	P01102200	1 x 25 A Kelvin test probe 6 m long		■	■						
	P01295488	Green earth lead with crocodile clip						■			
	P01120470	MR6292 clamp						■			
Other accessories											
	P01102013	CT 100 probe					■				
	P01102201	Set of 3 Input / Output connectors		■	■						
	P01102202	Three-phase / 16 A Banana adapter		■	■						
	P01120872	G72 clamp		■	■						
Measurement lead for ratiometer											
	P01295143A	Set of 2 spare leads, primary H, secondary X L= 4.6 m , compatible with DTR 8500 / DTR 8510	4 mm banana						■		
Adapters for cable and metal conductor locator											
	P01102114Z	Kit of 3 measurement adapters for housing (B22, E27, mains socket)	B22 bayonet E27 screw socket 2P mains socket							■	
Measurement lead for battery capacity tester											
	P01102103	Set of 2 double-contact current / voltage measurement leads for CA 6630 battery tester. L=1 m	Jack								■

ACCESSORIES / REPLACEMENT PARTS

INSTALLATION TESTERS

CA 6011

- Cable reeler no. 1 - 30 m.....P01295492
- 1 waist belt + 1 shoulder strap.....P01102171
- 30 m cable for reeler.....P01295493
- 2 elastic straps.....P01102172
- 1 set of replacement accessories.....P01102173
- Continuity rod.....P01102084A

CA 6030

- C172 current clamp.....P01120310
- C176 clamp.....P01120330
- MN20 current clamp.....P01120440
- Series printer no. 5.....P01102903
- 1P loop kit.....P01102020
- 3 crocodile clips
(red / white / yellow).....P01101905
- 3 test probes (red / white / yellow).....P01101906A
- Optical / RS232 connection cable.....P01295252
- 10 m green cable H winder.....P01102026
- T earth stake.....P01102031
- 100 m reel of green cable.....P01295266
- 33 m reel of green cable.....P01295268
- Standard bag no. 5.....P01298066

CA 6131, CA 6133

- Remote-control probe no. 4.....P01102157
- Three-pole EURO cable.....HX0300
- Neck strap.....HX0302
- Continuity rod.....P01102084A
- Test probes (red + black).....P01295454Z
- Crocodile clips (red + black).....P01295457Z
- 2 cables 1.5 m long (red / black).....P01295450Z
- Yellow bag no. 2.....P01298006

CA 6131

- MN73 clamp.....P01120421
- 1.5 V LR6 alkaline battery.....P01296033

CA 6133

- MN73A clamp.....P01120439
- Type R USB charger.....P01102186
- 4 x 1.2 V NiMH 2.4 AH AALSD batteries.....HX0051B
- 15 m basic earth kit
(yellow, green, red).....P01102019
- 50 m earth kit.....P01102021

INSULATION TESTERS

CA 6501 and CA 6503

- Bag no. 2.....P01298006
- CA 1246 thermo-hygrometer.....P01654246
- CA 1821.....P01654821
- 0.2 A / HRC fuse for CA 6501.....P01297095
- 2 crocodile clips (red / black).....P01295457Z
- 2 test probes (red / black).....P01295458Z
- 2 leads 1.5 m long (red / black).....P01295289Z
- 3 crocodile clips (red, black, blue).....P01103062
- 3 safety leads 1.5 m
(red, black, blue).....P01295171

CA 6511 and CA 6513

- CA 1246 thermo-hygrometer.....P01654246
- CA 1821.....P01654821
- 2 crocodile clips (red / black).....P01295457Z
- 2 test probes (red / black).....P01295454Z
- 2 leads 1.5 m long (red / black).....P01295289Z
- 1.5 V LR6 battery.....P01296033
- 1.6 A fuse.....P01297022
- Shockproof sheath no. 13.....P01298016

CA 6522, CA 6524, CA 6526, CA 6532, CA 6534 and CA 6536

- Remote-control probe.....P01101935A
- CA 1246 thermo-hygrometer.....P01654246
- CA 1821.....P01654821
- Hands-free bag.....P01298049
- 1.5 V LR6 battery.....P01296033
- Test probes (red + black).....P01295454Z
- Crocodile clips (red + black).....P01295457Z
- Elbowed-straight safety leads
(red + black) 1.5 m long.....P01295453Z
- DataView® software.....P01102095

CA 6528

- CA 1246 thermo-hygrometer.....P01654246
- CA 1821 thermometer.....P01654821
- 1.5 V LR6 battery.....P01296033
- Test probes (red + black).....P01295454Z
- Crocodile clips (red + black).....P01295457Z
- Elbowed-straight safety leads
(red + black) 1.5 m long.....P01295289Z

CA 6541 and CA 6543

- Remote-control probe.....P01101935
- CA 1246 thermo-hygrometer.....P01654246
- CA 1821.....P01654821
- AN1 artificial neutral box.....P01197201
- Bag no. 6 for accessories.....P01298051
- 1.5 V LR14 battery.....P01296034
- Fuse F 2.5 A - 1.200 V -
8 x 50 mm - 15 kA (x 5).....P01297071
- Fuse F 0.1 A - 660 V -
6.3 x 32 mm - 20 kA (x 10).....P01297072

CA 6543

- Series printer no. 5.....P01102903
- Series-parallel adapter.....P01101941
- DataView® software.....P01102095
- 1.5 m safety leads (red, blue, black).....P01295171
- RS232 PC DB 9F - DB 25F cable x 2.....P01295172
- RS 232 printer DB 9F - DB 9M
cable no. 01.....P01295173
- European 2P mains lead.....P01295174
- UK mains lead.....P01295253
- Battery pack.....P01296021

CA 6505, CA 6545, CA 6547 and CA 6549

- CA 1246 thermo-hygrometer.....P01654246
- CA 1821.....P01654821
- AN1 artificial neutral box.....P01197201
- Standard bag for accessories.....P01298066
- Fuse FF 0.1 A - 380 V -
5 x 20 mm - 10 kA (x 10).....P03297514
- European 2P mains lead.....P01295174

CA 6547 and CA 6549

- Series printer no. 5.....P01102903
- Series-parallel adapter.....P01101941
- DataView® report generation software.....P01102095
- RS 232 PC DB 9F - DB 25F cable x 2.....P01295172
- RS 232 printer DB 9F - DB 9M
cable no. 01.....P01295173

CA 6550 and CA 6555

- 2 red / black test probes.....P01295454Z
- 3 red / blue / black crocodile clips.....P01103062
- USB optical cable.....HX0056-Z
- Shoulder bag.....P01298066
- CA 1246 thermo-hygrometer.....P01654246
- CA 1821.....P01654821
- European 2P mains lead.....P01295174

CLAMP MULTIMETERS FOR LEAKAGE CURRENT

F65

- Red / black crocodile clamps (set of 2).....P01295457Z
- Elbowed test-probe leads, 1.5 m, (1 red / 1 black).....P01295456Z
- Soft case 200 x 100 x 40 mm with belt clip.....P01298065Z
- CMI214S current measurement lead.....P03295509
- Shoulder bag no. 21
(250 x 165 x 60 mm) with strap.....P06239502

EARTH AND RESISTIVITY TESTERS

CA 6421 and CA 6423

- Carrying strap.....P01298005
- Fuse HRC 0.1 A - 250 V (x 10).....P01297012
- 1.5 V LR06 battery.....P01296033
- Shoulder bag no. 2.....P01298006

CA 6422 and CA 6424

- 15 m earth kit (blue / green / red).....P01102017
- 50 m expert earth kit.....P01102021
- Carrying bag.....P01298006
- 4-point hands-free strap.....HX0302

CA 6422

- 1.5 V LR6 battery.....P01296033

CA 6424

- 4 x 1.2 V NiMH 2.4 AH AALSD batteries.....HX0051B
- Type-R USB charger.....P01102186
- G72 current clamp.....P01120872

CA 6416 and CA 6417

- DataView® software.....P01102095
- Bluetooth / USB modem.....P01102112
- Hard case.....P01298080
- CL1 calibration loop.....P01122301

CA 6418

- CL1 calibration loop.....P01122301
- MLT110* carrying case.....P01298080
- 1.5 V LR6 alkaline battery.....P01296033

*Requires 2 X convoluted foam inserts 691714A00

CA 6460 and CA 6462

- European 2P mains lead.....P01295174
- Fuse HRC 0.1 A - 250 V (x 10).....P01297012
- Battery pack.....P01296021
- 1.5 V LR06 battery.....P01296033
- Standard bag.....P01298066

CA 6470N, CA 6471 and CA 6472

- DataView® report generation software.....P01102095
- Adapter for battery charging
on vehicle cigarette lighter.....P01102036B
- Optical / RS communication cable.....P01295252
- UK mains lead.....P01295253
- Set of 10 fuses:
F 0.63 A - 250 V - 5 x 20 mm - 1.5 kA.....AT0094
- Adapter for battery charging
on the mains supply.....P01102035
- Battery pack.....P01296021
- Optical / USB communication cable.....HX0056-Z

CA 6471 and CA 6472

- MN82 clamp (diam. 20 mm) delivered with
2 m cable for connection to ES terminal.....P01120452
- C182 clamp (diam. 52 mm) delivered with
2 m cable for connection to ES terminal.....P01120333
- Standard bag.....P01298066

ACCESSORIES / REPLACEMENT PARTS

CA 6474

- Connection cable.....P01295271
- 15 m BNC / BNC cable.....P01295272
- 5 m AmpFlex® flexible current sensor.....P01120550
- 8 m AmpFlex® flexible current sensor.....P01120551
- Set of 12 identification rings for AmpFlex®.....P01102045
- Set of 3 adjustable clamps.....P01102046
- 5 m green cable (E terminal connection).....P01295291
- 5 m black cable (E terminal connection).....P01295292
- Spade lug / banana plug adapter.....P01102028
- Calibration loop.....P01295294
- Prestige bag.....P01298067

ELECTRICAL EQUIPMENT TESTERS

CA 6121

- Machine Link Windows processing software (supplied with communication cable).....P01101915
- Series printer no. 5.....P01102903
- DB9F-DB25M adapter.....P01101841
- Remote-control pedal.....P01101916
- Indicator lamps (green / red).....P01101917
- Roll of paper for series printer (set of 5).....P01101842
- 2 crocodile clips (red / black).....P01295457Z
- 2 test probes (red / black).....P01295458Z
- 2 dielectric test guns with 6 m cable.....P01101918
- 2 dielectric test guns with 2 m cable.....P01101919
- 2 safety leads 3 m long (red / black).....P01295097
- Continuity test lead 2.5 m long (black).....P01295137
- Continuity test lead 2.5 m long (red).....P01295140
- Discharge-time cable (European).....P01295141

CA 6155

- 4 m red test lead.....P01102139
- Red + black 1.5 m test lead.....P01102138
- Red 1.5 m test lead.....P01102140
- 1.5 m plug-in test cable.....P01102136
- 3 m test cable with separate wires.....P01102137
- Black test probe.....P01101141
- Red test probe.....P01102142
- Green test probe.....P01102143
- Blue test probe.....P01102144
- Set of 3 black crocodile clips.....P01102145
- Set of 10 fuses: 16 A-250 V 6 x 32 T.....P01297086
- Set of 2 HV cables.....P01103071
- HV crocodile clip.....P01103072
- HV test probe.....P01103073

CA 6165

- 1 remote-control pedal (type 2).....P01102177
- 2-lamp tower (red / green).....P01102178
- 4-lamp tower (red / green / blue / orange).....P01102179
- Lamp power supply adapter.....P01102180
- 2 x 2 m HV guns.....P01102182
- 2 x 3 m cables (red / black).....P01295097
- EURO discharge cable.....P01295141
- 1 double continuity cable.....P01295236
- 2 test probes, CAT IV 1kV (red / black).....P01295454Z
- 2 crocodile clips, CAT IV 1kV (red / black).....P01295457Z
- Time-delay fuse, 6 X 32 mm, 16 A 250 V (x10).....P01297102
- Fuse 5 X 20 mm 5 A 250 V (x10).....P01297103
- Standard carrying bag.....P01298066

OTHER TESTERS

CA 6240 and CA 6255

- 1 A double test probe (x 2).....P01102056
- Mini Kelvin clamp (set of 2).....P01101783
- UK mains lead.....P01295253

- CA 1846 thermo-hygrometer.....P01654246
- European 2P mains lead.....P01295174
- Standard bag.....P01298066
- 10 A-P clamp (set of 2).....P01101794
- DataView®.....P01102095
- Straight probe with 10 A double pivoting retractable test probe (x 2).....P01103063
- Gun with 10 A double retractable test probe (x 2).....P01103065

CA 6240

- Set of 10 fuses: 6.3 x 32 / 12.5 A / 500 V.....P01297091
- Optical / USB communication cable.....HX0056-Z

CA 6255

- Pt 100 temperature sensor.....P01102013
- 2 m cable for remote Pt 100.....P01102014
- RS 232 PC DB 9F – DB 25F cable x 2.....P01295172
- Set of 10 fuses: 6.3 x 32 / 16 A / 250 V.....P01297089
- Set of 10 fuses: 5.0 x 20 / 2 A / 250 V.....P01297090

CA 6292

- 1 set of 2 Kelvin leads 6 m long (red / black) with adjustable-clamp connections.....P01295486
- 1 set of 2 Kelvin leads 15 m long (red / black) with adjustable-clamp connections.....P01295487
- 1 green earth lead with crocodile clip.....P01295488
- 1 set of 5 fuses: T1 5 A 250 V 5x20 mm.....P01297101
- 1 USB-A USB-B cable 1.5 m long.....P01295293
- 1 MR6292 clamp.....P01120470
- Set of 2 leads 6 m long with 200 A Kelvin clamps.....P01295494
- Set of 2 leads 15 m long with 200 A Kelvin clamps.....P01295495
- Standard carrying bag.....P01298066

DTR 8510

- Set of 2 replacement leads 4.6 m long.....P01295143A
- Set of 2 replacement leads 10 m long.....P01295145
- USB cable.....P01295293
- Shoulder bag.....P01298066

CA 6681

- 33 m reel of green wire, battery clip / 4 mm male banana on winder with handle.....P01295268
- 10 m reel of green wire, battery clip / 4 mm male banana on H winder.....P01102026
- Kit of 3 measurement adapters for housing (B22, E27, mains socket).....P01102114Z

CA 6630

- Set of 2 leads with retractable test probes.....P01102103

See all our accessories
on page 150

INFO AND ADVICE	84
POWER AND HARMONICS CLAMPS	86
POWER AND ENERGY QUALITY ANALYSERS	88

ELECTRICAL MEASUREMENT LOGGERS	94
DATA PROCESSING SOFTWARE	102
ACCESSORIES	104

POWER AND DISTURBANCES

A phase of analysis is essential to precisely identify the behaviour of the installations and determine which solutions to implement. The measurements made help to ensure that the solutions are pertinent and that the gains achieved are maintained over the long term in the context of an energy optimization programme. **So measurement provides the foundation for optimizing your installations' energy efficiency**, supervising your electrical networks and fairly allocating the costs.

POWER MEASUREMENTS

Power measurement is a key element for the definition, success and long-term effects of an energy optimization programme. Reducing electricity consumption is also a simple, painless way of saving money. Electricity is a clean energy source which is less harmful for the environment, but it does affect it nevertheless. The various parameters of the installation are measured regularly, including the different power values used to size the electrical network and the phase shift data, as well as the voltage, current and frequency measurements.

For private customers, reactive power is neither measured nor billed separately. Instead it is included at a flat rate in the active power price. Things are very different for industrial customers, however. Electricity suppliers penalize consumers whose displacement power factor (cos phi or DPF) is lower than 0.93 (in France) or whose tan phi is higher than 0.4 (in France).

This set of measurements will help the installation manager to size the capacitor banks correctly.

Today, the IEEE1459 standard defines a measurement method for all the different power values. Thus, to compensate the phase shift, you can measure the fundamental reactive power Q1, which simplifies sizing of the capacitor bank required.



TROUBLESHOOTING DISTURBANCES

With the spread of systems incorporating electronics using switching power supplies, **the electrical network is becoming increasingly polluted**. A further complication is the fact that electricity market deregulation could lead to more frequent general network blackouts. The quality requirements have become much more demanding and stringent than in the past. All the equipment in factories and buildings now includes digital electronics which are known to be sensitive to micro-outages, peaks and dips, harmonics and disturbances in general.

IEC 61000-4-30

Today, there is uniformization of the measurement methods used to troubleshoot disturbances so that the results can be compared.

The IEC 61000-4-30 standard defines the measurement methods for energy quality measuring instruments, the time aggregation specifications and the minimum accuracy applicable to each energy quality parameter to obtain reliable, comparable results. These measurement methods are checked using tests described by the IEC 62586 standard.

Depending on the measurement method used (the standard authorizes certain choices) and the accuracy provided by the instrument, the instrument will be assigned to one of several categories: Class A, S or B. Class A instruments require regular, precise time resynchronization.

Harmonics and interharmonics

The complexity of industrial equipment makes it vulnerable to the voltage disturbances that occur on the electrical network. The arrival of new quick-switching components is leading to a large number of low-order harmonic currents (3, 5, 7, 9, 11, ...).

The waveform of the current consumed by loads connected to the electrical network is often no longer purely sinusoidal. This current distortion implies distortion of the voltage which also depends on the

impedance of the source. The disturbances called harmonics are caused by connecting non-linear loads, such as equipment incorporating power electronics, to the network. This may have instant consequences on certain electronic equipment: operating problems (synchronization, switching), untimely tripping, measurement errors on energy meters, etc. In the medium term, the extra heating caused by this may reduce the life span of rotating machines, capacitors, power transformers and neutral conductors.

Today's measuring instruments have to be capable of performing this harmonic analysis order by order, as well as measuring the Total Harmonic Distortion (THD) for more detailed diagnosis of the installation.

Variations

Some types of faults are encountered very frequently. In general, the main types of disturbances involve:

- **Slow voltage variations and transients**

The voltage amplitude is a crucial parameter for electricity quality.

The voltage amplitude varies abnormally and may even drop to a level close to zero. The causes mainly lie in the installation itself. The connection of heavy loads may lead to voltage variations if the short-circuit power at a point of supply is undersized. Several types of faults are then defined: overvoltage, voltage dip, outage, etc. The rated network voltage variation range is set by the power distributor.

- **Flicker: rapid voltage fluctuations**

When variable loads such as arc furnaces, laser printers, microwave ovens or air-conditioning systems are started up, they cause rapid voltage variations. This phenomenon is called flicker. In reality, the flicker value is the result of a statistical calculation based on measurements of the rapid voltage variations. A 10-minute interval is considered an acceptable compromise for evaluation of the short-term flicker (Pst).

If the combined effect of several disturbance-generating loads operating in a random way (e.g. welding units or motors) has to be taken into account or when flicker sources with long or variable operating cycles are involved (electric arc furnace), the resulting disturbance must be assessed over a longer time. The measurement duration defined is then 2 hours, a time considered appropriate for the load operating cycle or the time during which an observer may be sensitive to long-term flicker (PIt).

The instruments used to analyse electrical networks and record disturbances for the industries and professionals in the electrical sector (generators, transmission companies, electricity users) **are essential tools for monitoring and timely installation of installations**. They must provide direct measurement, allow the maximum possible parameterization and permit subsequent analysis.

POWER QUALITY & INSTALLATION MONITORING

DATA LOGGING MADE SIMPLE

FOR ECONOMICAL, SUSTAINABLE BUILDINGS, IMPROVE YOUR ENERGY EFFICIENCY

In the context of a worldwide drive to protect the environment, many countries have set targets for reducing their energy consumption. **Today, more than 50% of energy consumption occurs in industry and in buildings.** Energy consumption therefore needs to be optimized to meet the regulatory requirements. There are rules imposing tests and improvements with regard to energy consumption.

By analysing the structure (building, insulation, etc.), users can control passive energy efficiency. Then, by using high-performance instruments and smart measuring and control systems (variable speed drives or load-shedding devices), **it will be possible to adjust the operating conditions and thus, more generally, the active energy efficiency.**

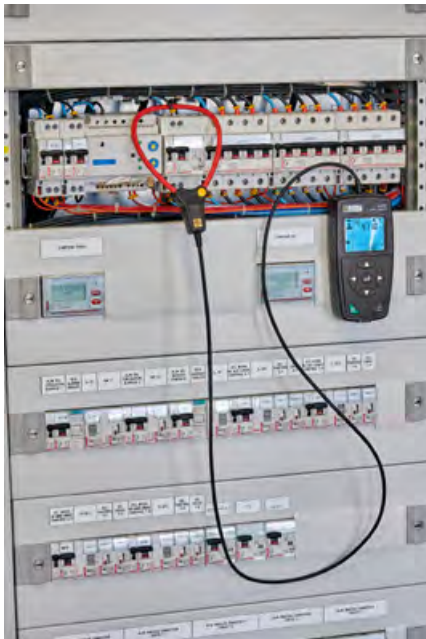

THE EN 16247 STANDARD

The EN 16247-1 standard defines the general methodological and quality requirements for preparation, execution and reporting of the audit. **These methods are defined according to the activity audited:**

- for buildings: EN 16247-2
- for industrial processes: EN 16247-3
- for transport: EN 16247-4

In all cases, measurement campaigns are necessary to check the efficiency of the equipment, the periods when it is used and the real condition of the building shells.

The data loggers family is **a product line with a wide range of applications.** They are suitable for:

- electrical installations, whether involving three-phase power or lower,
- multifunction requirements, or highly accurate measurements for a sector

A full set of alarm programming tools allows you to program alarm set points and triggering on high or low thresholds, or inside or outside a predefined range.

When connected to a communication network, you can be immediately informed about this alarm by email.

Low-consumption technologies or solutions powered directly via the measurement channels give these

instruments the necessary autonomy for effective recording campaigns.

All these measuring solutions are naturally now compatible with complementary software tools. They will also be the interface for remote tests or data downloading.

APPLICATIONS

- Neutral current monitoring to detect unwanted leakage currents
- Real-time current harmonics monitoring to locate unwanted energy which causes equipment failure
- Load profiling which sizes loads to optimize transformer and meter selection
- Split-phase load monitoring for residential voltage and current
- Machine load monitoring detects overload conditions causing premature equipment failure due to overheating
- Process loop monitoring can detect problematic sensors and control systems
- HVAC and general temperature profiling (refrigeration and air-conditioning systems)

CHOOSE YOUR POWER ANALYSER / CLAMP



	F407 page 87	F607 page 87	CA 8220 page 87	CA 8331 page 88	CA 8333 page 89	CA 8336 page 90	CA 8436 page 91	CA 8345 page 92
Display								
Analogue								
Digital	■	■	■	■	■	■	■	■
Graphical				■	■	■	■	■
No. of inputs								
	1U/1I	1U/1I	1U/1I	3U/3I	3U/3I	4U/4I	4U/4I	4U/4I
Current								
AC	■	■	■	■	■	■	■	■
DC	■	■	■	■	■	■	■	■
Range	1,000 A	2,000 A	Depending on sensor	Depending on sensor	Depending on sensor	Depending on sensor	Depending on sensor	Depending on sensor
Voltage								
AC	1,000 V	1,000 V	600 V	1,000 V	1,000 V	1,000 V	1,000 V	1,000 V
DC	1,000 V	1,000 V	600 V	1,000 V	1,000 V	1,000 V	1,000 V	1,000 V
DPF PF								
	■	■	■	■	■	■	■	■
Harmonics								
THD/orders	■ /25	■ /25	■ /50	■ /50	■ /50	■ /50	■ /50	■ /63
Power								
	PQS	PQS	PQS	PNQ+DS	PNQ+DS	PNQ+DS	PNQ+DS	PNQ+DS
Data storage								
Internal	■	■	■	■	■	■	■	
SD card				■	■	■	■	■
Recording								
Trend	■	■		■	■	■	■	■
Alarms					■	■	■	∞
Transients					80 µs	80 µs	80 µs	2.5 µs
Images			99	12	12	50	50	∞
Inrush	■	■	■			■	■	∞
Surge								12kV
Monitoring								EN50160
Standards								
IEC61010	1000V CAT IV	1000V CAT IV	600V CAT III	600V CAT IV - 1000 V CAT III				1000V CAT IV
IEC61000-4-30						Class B	Class B	Class A
IEC 60529	IP54	IP54	IP54	IP53	IP53	IP53	IP67	IP54
Temperature			■					
Resistance			■					
Rotation speed			■					
Unbalance								
				■	■	■	■	■
Flicker								
				PST	PST	PST/PLT	PST/PLT	PST/PLT
Communication								
USB			■	■	■	■	■	■
Wifi								■
Bluetooth	■	■						■
Ethernet / IRD server								■ / ■
Power supply								
Batteries	■	■	■					
Mains			■	■	■	■	■	■
Rechargeable batteries			■	■	■	■	■	■
Power supply via the phase								
				Opt.	Opt.	Opt.	Integrated	Opt.

F407 - F607

REF.: P01120947 REF.: P01120967



★ STRENGTHS

- Measurements up to 2,000 Aac or 3,000 Adc or Aac+Dc
- Clamping Ø 60 mm
- Harmonic analysis up to the 25th order
- TruInrush function
- 3-year warranty



⚙️ SPECIFICATIONS

	F407	F607
Current (RMS)		
AC	100 mA to 1,000 A	100 mA to 2,000 A
DC and AC+DC	100 mA to 1,500 A	100 mA to 3,000 A
Best accuracy	1 % reading + 3 counts	
Voltage (RMS)		
AC	100 mV to 1,000 V	
DC and AC+DC	100 mV to 1,000 V	
Best accuracy	1 % reading + 3 counts	
Auto AC/DC	Yes (V and A)	
Resistance	100 kΩ	
Continuity/buzzer	Yes (< 40 Ω)	
Power W (P), var (Q1), VA (S)	Yes, single-phase and total three-phase	
Crest factor (CF)	Yes	
PF and cos φ (DPF)	Yes / Yes	
Auto power-off	Yes	
Hold function	Yes	
Backlighting function	Yes	
Min Max key	Yes	
Peak +/- 100 ms function	Yes / Yes	
True Inrush function	Yes	
THD-f / THD-r harmonics function	Yes / Yes	
Decomposition into harmonic orders	25 th	
REC storage function	Yes	
Recordings (with Min, Max)	Up to 3,000 measurements	
Bluetooth communication function	Yes	
Frequency	15 Hz to 20 kHz	
Clamping diam.	48 mm	60 mm
Protection	IP 54	
Electrical safety	IEC 61010 1000 V CAT IV	
Warranty	3 years	
Dimensions / weight	272 x 92 x 41 mm - 600 g (with batteries)	296 x 111 x 41 mm - 640 g (with batteries)

📦 CONTENTS

F407 and F607 delivered in a bag pre-equipped for MultiFix

- 1 set of banana/banana leads (red/black)
- 1 set of test probes (red/black)
- 1 set of crocodile clips (red/black)
- 4 x 1.5 V LR6 batteries
- 1 safety datasheet
- 1 CD-Rom containing a user manual and the PC data recovery software (Power Analyser Transfer)

⚙️ ACCESSORIES / REPLACEMENT PARTS

Set of banana/banana leads (red/black)	P01295451Z
Set of crocodile clips (red/black)	P01295457Z
See all the accessories on page 150	

CA 8220

REF.: P01160620



MOTOR MAINTENANCE



★ STRENGTHS

- Access to all the measurements simultaneously
- Low resistance and high current measurements
- Motor temperature measurement
- Motor rotation speed



⚙️ SPECIFICATIONS

	CA 8220
Voltage (TRMS)	Phase/Phase: 660 V _{AC+DC} Phase/Neutral: 600 V _{AC+DC}
Current (TRMS)	
MN clamp	MN93: 2 to 240 A _{AC} ; MN93A: 0.005 A _{AC} to 5 A _{AC} / 0.1 A _{AC} to 120 A _{AC}
C clamp	3 A to 1,200 A _{AC}
AmpFlex® or MiniFlex	30 A to 6,500 A _{AC}
PAC	10 A to 1,000 A _{AC} / 10 A to 1,400 A _{DC}
E3N/E27	50 mA to 10 A _{AC+DC} , 100 mA to 100 A _{AC+DC}
Frequency	40 Hz to 70 Hz
Other measurements	W (P), var (Q1), PF, DPF, VA (S), temperature, phase rotation, RPM, resistance, continuity, diode test, Wh, VAh, varh
Harmonics	Orders 1 to 50
Sampling rate	256 samples/period
Recording capacity	≥ 99 complete sets of voltage, current, power and harmonics measurements
Power supply	6 x 1.5 V LR06 batteries, mains power supply option
Battery life	≥ 8 hours with display activated
Communication	Optical USB
Display	3-display backlit screen with symbols
Dimensions / weight	211 x 108 x 60 mm / 0.88 kg
Electrical safety	IEC 61010 600 V CAT III, IP 54, pollution degree 2

📦 CONTENTS

- CA 8220
- 2 banana leads
- 2 x 4 mm test probes
- 2 crocodile clips
- 6 x 1.5 V LR06 batteries
- 1 optical USB cable
- Power Analyser Transfer processing software
- 1 CD-ROM containing the user's manual

➕ ADDITIONAL INFO

- The CA 8220 analyser is also available with a current sensor:
CA 8220 MN93A..... P01160621

⚙️ ACCESSORIES / REPLACEMENT PARTS

CA 1711 tachometric sensor	P0110208Z
2-wirePt100 adapter	HX0091
See all the accessories on page 150	

CA 8331

REF.: PO1160511

1000 V
CAT III

600 V
CAT IV

3U
4I

IP
53

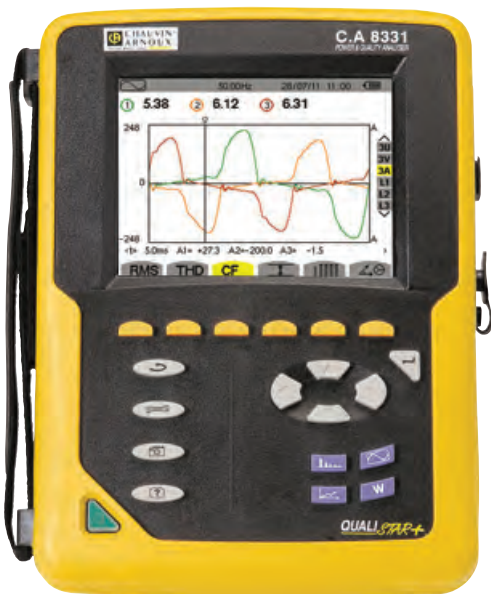

SPECIFICATIONS

		CA 8331
Number of channels		3U / 4I
Number of inputs		4V / 3I
Voltage (TRMS AC+DC)		2 V to 1,000 V up to 500 kV
	Voltage ratio	
Current (TRMS AC+DC)	MN	MN93: 500 mA to 200 A _{AC} ; MN93A: 0.005 A _{AC} to 100 A _{AC}
	C193	1 A to 1,000 A _{AC}
	AmpFLEX® or MiniFlex	100 mA to 10,000 A _{AC}
	PAC93	1 A to 1,300 A _{AC/DC}
	E3N	50 mA to 100 A _{AC/DC}
	J93	50 A to 3,500 A _{AC} / 50 A to 5,000 A _{DC}
	Current ratio	Up to 60 kA
Frequency		40 Hz to 69 Hz
Power values		W (P), VA (S), var (Q1, N, D), PF, DPF, cos φ, tan φ
Energy values		Wh, varh (Q1h, Nh, Dh), VAh
Harmonics		Yes
	THD	Yes, orders 0 to 50, phase
Flicker		Pst
Unbalance		Yes
Min/Max recording of a selection of parameters at max. sampling rate		Yes From a few hours to several days
Peak		Yes
Vectorial representation		Automatic
Display		Colour ¼ VGA TFT screen; 320 x 240, diagonal 148 mm
Screenshots and curves		12
Electrical safety		IEC 61010-1 000 V CAT III / 600 V CAT IV
Ingress protection		IP53 / IK08
Languages		More than 27
Communication interface		USB
Battery life		Up to 10 hours
Power supply		Rechargeable 9.6 V NiMH rechargeable battery or mains power supply
Dimensions / weight		240 x 180 x 55 mm / 1.9 kg

STRENGTHS

- TRMS AC+DC voltage and current, frequency
- Measurements for power surveys
- Measurements for sizing the anti-harmonic filters
- Simultaneous recording of all the parameters

ADDITIONAL INFO

- The Power Analyser Transfer software for recovering the data on your PC is supplied as standard

FUNCTIONS

- Real-time display of the waveforms (4 voltage inputs, 3 current inputs)
- Measurement of RMS voltages and currents per ½-period
- Intuitive use
- Automatic recognition of the different types of current sensors
- Voltage and current ratios
- Mixing of current sensors
- Measurement, calculation and display of the harmonics up to the 50th order, along with their phase information
- Calculation of the Total Harmonic Distortion (THD)
- Display of the phasor diagram
- Power measurements: VA, W, VAD, total var and var per phase
- Energy measurement: VAh, Wh, VADh, total varh and varh per phase
- Calculation of the K factor – FHL
- Calculation of the displacement power factor cos φ (DPF) and the power factor PF
- Calculation of Flicker PST
- Calculation of the unbalance (current and voltage)
- Backup and recording of screenshots (image and data)
- Recording and export on PC
- Real-time PC data recovery and communication software

CONTENTS

CA 8331 delivered with:

- 1 bag No.22
- 1 USB cable
- 1 mains adapter
- 4 x 3 m voltage cables with 4 mm banana connections
- 4 crocodile clips
- 1 safety datasheet
- 1 set of 12-colour markers for the cables and inputs
- 1 scratchproof protective screen film (mounted)
- 1 CD-ROM containing the Power Analyser Transfer PC data recovery software



Don't forget to order your current sensors too: see page 104

CA 8333

REF.: P01160541

1000 V CAT III 600 V CAT IV 3U 4I IP 53



STRENGTHS

- TRMS AC+DC voltage and current, frequency
- Measurements for power surveys
- Measurements for sizing the anti-harmonic filters
- Recording of all the parameters simultaneously
- Capture of all the transients, alarms and waveforms

ADDITIONAL INFO

- Possibility of Essallec-type current connection

FUNCTIONS

- Real-time display of the waveforms (4 voltage inputs and 4 current inputs)
- RMS voltage and current measurements by the ½-period
- Intuitive use
- Automatic recognition of the different types of current sensors
- Integration of all the DC components
- Voltage and current ratios
- Mixing of current sensors
- Measurement, calculation and display of the harmonics up to the 50th order, along with their phase information
- Calculation of the Total Harmonic Distortion (THD)
- Capture of transients as short as one sample (1/256th of a period)
- Display of phasor diagram
- Power measurements: VA, W, VAD, total var and var per phase
- Energy measurement: VAh, Wh, VADh, total varh and varh per phase
- Calculation of the K factor – FHL
- Calculation of the Displacement Power Factor cos φ (DPF) and power factor PF
- Capture of up to 50 transients
- Calculation of Flicker PST
- Calculation of the unbalance (current and voltage)
- Electrical network supervision with setting of alarms
- Backup and recording of screenshots (image and data)
- Recording and export on PC
- Real-time PC data recovery and communication software

CONTENTS

CA 8333 delivered with:

- 1 bag No. 22
- 1 USB cable
- 1 mains adapter
- 4 x 3 m voltage cables with 4 mm banana connections (5 cables for CA 8336)
- 4 crocodile clips (5 clips for CA 8336)
- 1 safety datasheet
- 1 set of 12-colour markers for the cables and inputs
- 1 scratchproof protective screen film (mounted)
- 1 CD-ROM containing the Power Analyser Transfer PC data recovery software



SPECIFICATIONS

		CA 8333
Number of channels		3U / 4I
Number of inputs		4V / 3I
IEC 61000-4-30		EN50160 reports
Voltage (TRMS AC+DC)		2 V to 1,000 V
	Voltage ratio	Up to 500 kV
Current (TRMS AC+DC)	MN	MN93: 500 mA to 200 Aac ; MN93A: 0.005 Aac to 100 Aac
	C193	1 A to 1,000 Aac
	AmpFLEX® or MiniFlex	100 mA to 10,000 Aac
	PAC93	1 A to 1,300 Aac/bc
	E3N	50 mA to 100 Aac/bc
	J93	50 A to 3,500 Aac / 50 A to 5,000 Adc
	Current ratio	Up to 60 kA
Frequency		40 Hz to 69 Hz
Power values		W (P), VA (S), var (Q1, N, D), PF, DPF, cos φ, tan φ
Energy values		Wh, varh (Q1h, Nh, Dh), VAh
Harmonics		Yes
	THD	Yes, orders 0 to 50, phase
	Expert mode	Yes
Transients		50
Flicker		Pst
Unbalance		Yes
Min/Max	recording	Yes
	of a selection of parameters at max. sampling rate	From a few days to several weeks
Alarms		4,000 of 10 different types
Peak		Yes
Vectorial representation		Automatic
Display		Colour ¼ VGA TFT screen, 320 x 240, diagonal 148 mm
Screenshots & curves		12
Electrical safety		IEC 61010 1 000 V CAT III / 600 V CAT IV
Ingress protection		IP53 / IK08
Languages		More than 27
Communication interface		USB
Battery life		Up to 10 hours
Power supply		Rechargeable 9.6 V NiMH battery or mains power supply
Dimensions / weight		240 x 180 x 55 mm / 1.9 kg



Don't forget to order
your current sensors too: see **page 104**

CA 8336

REF.: PO1160591

1000 V CAT III	600 V CAT IV	4U 4I	IP 53	IEC 61000-4-30	EN 50160
-------------------	-----------------	----------	----------	-------------------	-------------



SPECIFICATIONS

		CA 8336
Number of channels		4U / 4I
Number of inputs		5V / 4I
IEC 61000-4-30		EN50160 reports
Voltage (TRMS AC+DC)		2 V to 1 000 V
	Voltage ratio	Up to 500 kV
Current (TRMS AC+DC)	MN	MN93: 500 mA to 200 A _{AC} ; MN93A: 0.005 A _{AC} to 100 A _{AC}
	C193	1 A to 1,000 A _{AC}
	AmpFLEX® or MiniFlex	100 mA to 10,000 A _{AC}
	PAC93	1 A to 1,300 A _{AC/DC}
	E3N	50 mA to 100 A _{AC/DC}
	J93	50 A to 3,500 A _{AC} / 50 A to 5,000 A _{DC}
	Current ratio	Up to 60 kA
Frequency		40 Hz to 69 Hz
Power values		W (P), VA (S), var (Q1, N, D), PF, DPF, cos φ, tan φ
Energy values		Wh, varh (Q1h, Nh, Dh), VAh
Harmonics		Yes
	THD	Yes, orders 0 to 50, phase
	Expert mode	Yes
Transients		210
Flicker		Pst and PIt
Inrush mode		Yes > 10 minutes
Unbalance		Yes
Min/Max recording of a selection of parameters at max. sampling rate		Yes From 2 weeks to several years
Alarms		10,000 of 40 different types
Peak		Yes
Vectorial representation		Automatic
Display		Colour ¼ VGA TFT screen, 320 x 240, diagonal 148 mm
Screenshots & curves		50
Electrical safety		IEC 61010 1 000 V CAT III / 600 V CAT IV
Ingress protection		IP53 / IK08
Languages		Plus de 27
Communication interface		USB
Battery life		Up to 10 hours
Power supply		Rechargeable 9.6 V NiMH battery or mains power supply
Dimensions / weight		240 x 180 x 55 mm / 1.9 kg

STRENGTHS

- TRMS AC+DC voltage and current, frequency
- Measurements for power surveys
- Measurements for sizing the anti-harmonic filters
- Inrush mode (startup of the load)
- Capture of all transients, alarms and waveforms

ADDITIONAL INFO

- Module for power supply by the phase (option) for unlimited recording

FUNCTIONS

- Real-time display of the waveforms (5 voltage inputs and 4 current inputs)
- RMS voltage and current measurements by the ½-period
- Intuitive use
- Automatic recognition of the different types of current sensors
- Integration of all the DC components
- Voltage and current ratios
- Mixing of current sensors
- Measurement, calculation and display of the harmonics up to the 50th order, along with their phase information
- Calculation of the Total Harmonic Distortion (THD)
- Capture of transients as short as one sample (1/256th of a period)
- Display of phasor diagram
- Power measurements: VA, W, VAD, total var and var per phase
- Energy measurement: VAh, Wh, VADh, total varh and varh per phase
- Calculation of the K factor – FHL
- Calculation of the Displacement Power Factor cos φ (DPF) and power factor PF
- Capture of up to 210 transients
- Calculation of Flicker PST & PLT
- Calculation of the unbalance (current and voltage)
- Electrical network supervision with setting of alarms
- Backup and recording of screenshots (image and data)
- Recording and export on PC
- Real-time PC data recovery and communication software
- EN 50160 report

CONTENTS

CA 8336 delivered with:

- 1 bag No. 22
- 1 USB cable
- 1 mains adapter
- 5 x 3 m voltage cables with 4 mm banana connections
- 5 crocodile clips
- 1 safety datasheet
- 1 set of 12-colour markers for the cables and inputs
- 1 scratchproof screen protection film (mounted)
- 1 CD-ROM containing the Power Analyser Transfer PC data recovery software



Don't forget to order your current sensors too: see page 104

CA 8436

REF.: P01160595

1000 V CAT III	600 V CAT IV	4U 4I	IP 67	IEC 61000-4-30	EN 50160
-------------------	-----------------	----------	----------	-------------------	-------------

Diagnostics & testing	Education	Energy efficiency	Transport	Tertiary & residential	Industries	Generation, transmission & distribution	Laboratory & metrology
-----------------------	-----------	-------------------	-----------	------------------------	------------	---	------------------------

★ STRENGTHS

- Power supply via the phase
- Measurements for power surveys
- Measurements for sizing the anti-harmonic filters
- Recording of all the parameters simultaneously
- Capture of all the transients, alarms and waveforms

⚙️ FUNCTIONS

- Real-time display of the waveforms (5 voltage inputs and 4 current inputs)
- RMS voltage and current measurements per 1/2-period
- Intuitive use
- Automatic recognition of the different types of current sensors
- Integration of all the DC components
- Voltage and current ratios
- Mixing of current sensors
- Measurement, calculation and display of the harmonics up to the 50th order, along with their phase information
- Calculation of the Total Harmonic Distortion (THD)
- Capture of transients as short as one sample (1/256th of a period)
- Display of phasor diagram
- Power measurements: VA, W, VAD, total var and var per phase
- Energy measurements: VAh, Wh, VADh, total varh and varh per phase
- Calculation of K factor – FHL
- Calculation of the Displacement Power Factor cos φ (DPF) and the power factor PF
- Capture of up to 210 transients
- Calculation of Flicker PST & PLT
- Calculation of unbalance (current and voltage)
- Electrical network supervision with setting of alarms
- Backup and recording of screenshots (image and data)
- Recording and export on PC
- Real-time PC data recovery and communication software
- EN 50160 report



➕ ADDITIONAL INFO

- Specific watertight AmpFlex® and MiniFlex current sensors are available

⚙️ SPECIFICATIONS

		CA 8436
Number of channels		4U / 4I
Number of inputs		5V / 4I
IEC 61000-4-30		-
Voltage (TRMS AC+DC)		2 V to 1,000 V Up to 500 kV
Voltage ratio		Up to 500 kV
Current (TRMS AC+DC)	MN	MN93: 500 mA to 200 Aac ; MN93A: 0.005 Aac to 100 Aac
	C193	1 A to 1,000 Aac
AmpFLEX® or MiniFlex		30 A to 6,500 Aac
PAC93		1 A to 1,300 Aac/bc
E3N		50 mA to 100 Aac/bc
J93		50 A to 3,500 Aac / 50 A to 5,000 Adc
Current ratio		Up to 60 kA
Frequency		40 Hz to 69 Hz
Power values		W (P), VA (S), var (Q1, N, D), PF, DPF, cos φ, tan φ
Energy values		Wh, varh (Q1h, Nh, Dh), VAh
Harmonics		Yes
THD		Yes, orders 0 to 50, phase
Expert mode		Yes
Transients		210
Flicker		Pst and Plt
Inrush mode		Yes > 10 minutes
Unbalance		Yes
Min/Max recording of a selection of parameters at max. sampling rate		Yes From 2 weeks to several years
Alarms		10,000 of 40 different types
Peak		Yes
Vectorial representation		Automatic
Display		Colour 1/4 VGA TFT screen, 320 x 240, diagonal 148 mm
Screenshots & curves		12
Electrical safety		IEC 61010 1 000 V CAT III / 600 V CAT IV
Ingress protection		IP67
Languages		More than 27
Communication interface		USB
Battery life		Up to 10 hours
Power supply		Rechargeable 9.6 V NiMH battery or mains power supply
Dimensions / weight		270 x 250 x 180 mm / 3.7 kg

📦 CONTENTS

CA 8436 delivered with:

- 1 bag No. 22
- 1 waterproof power cord
- 1 USB cable
- 1 mains adapter IP65
- 5 x 3 m voltage cables with 4 mm banana connections with waterproof connector
- 5 crocodile clips
- 1 set of waterproof caps
- 1 set of 12-colour markers for the cables and inputs
- 1 scratchproof screen protection film (mounted)
- 1 safety datasheet
- 1 CD-ROM containing the Power Analyser Transfer PC data recovery software

Don't forget to order your current sensors too: see page 104

CA 8345

REF.: P01160657

1000 V
CAT IVIP
54CEI
61000-4-30Diagnostics
& testing

Education

Energy
efficiency

Transport

Tertiary
& residential

Industries

Generation,
transmission
& distributionLaboratory
& metrology

★ STRENGTHS

- Full compliance with IEC 61000-4-30 in Class A
- Extra-communicating instrument
- Qualistar range of easy-to-use products

✚ ADDITIONAL INFO

- Also available in a version powered via the voltage channels up to 1,000 V_{AC} and DC.

📦 CONTENTS

CA 8345 delivered with:

- Safety datasheet
- Multilingual Quick Start Guide
- USB cable + Charger for Europe
- Verification certificate
- Removable handle strap
- Set of 5 banana leads and crocodile clips
- 5 reeling boxes
- USB A/B cable, length 1.80 m
- Set of identification rings and inserts
- Magnetic hook
- SD memory card
- PA40W-2 mains power pack and charger with mains power lead
- Carrying bag



Don't forget to order
your current sensors too: see **page 104**

⚙️ SPECIFICATIONS

	CA 8345
Inputs	Isolated voltage/current inputs
Voltage	Up to 1,000 V _{AC} DC
IEC 61000-4-30 (Ed 3)	Class A (Full)
Screen	7" colour touch LCD: 800 x 480 (WVGA)
Battery cartridge	Li-ion
Real-time mode	Yes
Sampling rate	400 kpsps for voltage and 200 kpsps for current
Power mode	Yes
Energy mode	Yes
Unbalance mode	Composite
Harmonics mode	DC to 63rd order
Interharmonics mode	Orders 0 to 62
Trend recording	> 900 parameters
Recording of phase of harmonics	Yes
Alarm mode (type / number)	52 / 20,000
Carrier current detection mode	Yes
Inrush capture	100
Transients (number)	No maximum (SD card)
Shockwaves	Up to 12 kV over a duration of 500 ns @ 2 Msps
EN50160 monitoring mode	With PAT3 software
USB communication	Yes
SD card	Externally accessible
Ethernet	Yes
Wifi	Yes
Webserver	Yes
USB key port (Type A)	Yes
Wide range of current sensors	See page 140
IEC 61010 safety	CAT IV 1000V
Protection	IP54
Temperature	[+0 °C; +40 °C]
Environmental conditions	IEC 61557-12 & IEC 62586
Dimensions (H x W x D)	200 x 285 x 55 mm / 1.9 kg
Warranty	3 years

⚙️ ACCESSORIES / REPLACEMENT PARTS

1,000 V STD PA32ER power supply	P01103076
PA40W-2 mains adapter	P01102155
C8 adapter	P01103077
Bag	P01298083
SD card	P01103078
Magnetized hook	P01103079
Handle strap	HX0122
External battery charging station	P01102130
Li-ion battery pack	P01296047

FTV500

REF.: P01129600



SPECIFICATIONS

	FTV500
Number of channels	6 (3 DC voltage and current channels, 3 AC voltage and current channels)
Connection	4 mm banana plugs
Measurement ranges	
V _{DC}	3 to 999.9 V _{DC}
V _{AC} @ 50/60 Hz	3 to 700.0 V _{AC}
I _{DC}	1 to 1,400 A _{DC}
I _{AC} @ 50/60 Hz	1 to 3,000 A _{AC}
Environment	
Irradiation	50 to 2,000 W/m ²
Contact temperature	-20 °C to + 150°C
Ambient temperature	-20 °C to + 150°C
I-V curves	
DC power	5 to 9 999 W _{DC}
Continuity	
Measurement range	0.01 to 99 Ω, > 200mA (IEC 61557-4)
Insulation	
Test voltage	250-500-1,000 V
Measurement range (without voltage)	0.25 to 1 MΩ
Measurement range (with voltage)	0.25 to 1 MΩ
DC-AC performance	
Measurements performed simultaneously	Irradiation, temperature (ambient/module), AC/DC power values (measured and theoretical available), Power Factor, AC/DC, voltage, AC/DC current, PRp performance ratio and AC/DC performance, V-I vectorial diagram
Recording	
Measurements performed simultaneously	Irradiation, temperature (ambient/module), AC/DC power values (measured and theoretical available), Power Factor, AC/DC, voltage, AC/DC current, PRp performance ratio and AC/DC performance
General	
Display	5" TFT touch screen, 16 million colours, 800x480
Wifi	Real-time Wi-Fi transmission, mode / real-time synchronization and recording of data if signal lost
Interface	
Instrument	VNC remote control
Remote unit	Wifi transmission
Data storage	
I-V curves	Programmable internal database: sites / installations / companies / modules / measurements, with tree-structure. Memory: more than 10,000 blocks for all the measurements.
Logger	Logger: 600,000 measurements for data logging
Power supply / Battery life	
Instrument	Li-ion rechargeable batteries and 100-240V mains power supply @ 50-60Hz / Battery life 15 hours
Remote unit	Li-ion rechargeable batteries with USB charging cable / Battery life 15 hours
Mechanical specifications	
Dimensions	340 x 300 x 200mm
Weight	6 kg
Electrical safety	IEC 61010, 1000 V CAT II, 600 V CAT IV
Protection (instrument & remote)	IP54 (IEC 60529)
Warranty	2 years



STRENGTHS

- Touch screen
- 5 instruments in 1: converter efficiency, I-V curves, continuity test, insulation test, logger
- Live insulation tests
- EN62446, EN60891, EN60904, IEC 82-25, EN61557, IEC 64-8 and EN61010 standards

ADDITIONAL INFO

- Installation and maintenance tests on solar power installations
- Verification during installation of solar power installations

CONTENTS

FTV500 delivered with:

- Carrying bag
- Certificate of conformity
- 12 red/black banana leads 2 m long
- 12 crocodile clips
- 3 x MiniFlex MA500 AC sensors
- 3 x PAC500 DC sensors
- I-V cable for DC connection
- USB cable
- FTV500 mains adapter
- FTV500 remote unit
- User's manual (5 languages) on USB key
- Software on USB key
- Incliner



ACCESSORIES / REPLACEMENT PARTS

MiniFlex MA500	P01120080
PAC500 DC clamp	P01120600
FTV500 remote unit	P01102184
Incliner	P01102115

CHOOSE YOUR ELECTRICAL MEASUREMENT LOGGER



	PEL51 page 95	PEL52 page 95	PEL102 page 96	PEL103 page 96	PEL104 page 96	PEL106 page 97	L411 page 98	L412 page 99	L461 page 100	DL913 page 101	DL914 page 101	L452 page 101
Display												
Without			■							■	■	
With	■	■		■	■	■	■	■	■			■
No. of inputs												
	1U/1I	2U/2I	3U/3I	3U/3I	3U/3I	4U/4I	1I	2I	1U	3I	4I	2/U
Current												
AC	■	■	■	■	■	■	■	■		■	■	
DC			■	■	■	■						4-20 mA
Voltage												
AC	690 V	690 V	1,000 V	1,000 V	1,000 V	1,000 V			1,000 V			
DC			1,000 V	1,000 V	1,000 V	1,000 V			1,500 V			0-10 V
Process												
4-20 mA					■	■						■
0-10 V					■	■						■
Power values												
	PNQ ₁ DS	PNQ ₁ DS	PQS	PQS	PNQ ₁ DS	PNQ ₁ DS						
Data storage												
Internal												■
SD card	■	■	■	■	■	■	■	■	■	■	■	
Communication												
USB			■	■	■	■	■	■	■	■	■	■
Wifi	■	■			■	■	■	■	■	■	■	
Bluetooth			■	■	■	■						■
RJ45			■	■	■	■						
Webserver	■	■					■	■	■			
GPRS					■	■						
IRD server	■	■			■	■	■	■	■	■	■	
Power supply												
	Mains via the phase	Mains via the phase	Mains via the phase (opt)	Mains via the phase (opt)	Mains via the phase (opt)	Mains via the phase	Batteries	Batteries	Batteries	Batteries	Batteries	Batteries
Protection												
	IP54	IP54	IP54	IP54	IP54	IP67	IP54	IP54	IP54	IP65	IP65	IP54
Safety												
IEC 6010	CAT III 600V	CAT III 600V	CAT III 1000V CAT IV 600 V	CAT III 1000V CAT IV 600 V	CAT III 1000V CAT IV 600 V	CAT IV 1000V	CAT III 1000V		CAT III 1000V	CAT III 1000V	CAT III 1000V	CAT II 300V

PEL51 - PEL52

REF.: P01157166

REF.: P01157167

600V
CAT III



TRMS



★ STRENGTHS

- Measurement up to 690 V
- Power supply via the phase
- Alarm function

+ ADDITIONAL INFO

- Monitoring of voltage variations,
- Electrical troubleshooting, etc.

📦 CONTENTS

- PEL51 or PEL52
- Verification sheet
- Safety datasheet
- 2 banana leads 1.5 m long for PEL51, 3 banana leads 1.5 m long for PEL52
- 2 crocodile clips for PEL51, 3 crocodile clips for PEL52
- C8 banana adapter
- Quick Start Guide in 15 languages
- User's manual available for downloading
- PEL Transfer software available for downloading
- 1 mains power cable

⚙️ SPECIFICATIONS

	PEL51	PEL52
Display	Backlit LCD (blue) with double display Real-time measurements	
Type of installation	Single-phase	Single-phase, split-phase, two-phase
Number of channels	1V / 1I	2V / 2I
Type of inputs	2 x 4mm terminals + 1 Qualistar-type current input	3 x 4mm terminals + 2 Qualistar-type current inputs
Measurements		
Network frequencies	DC, 50 Hz, 60 Hz	
Voltage (measurement range)	10 V _{AC} to 690 V _{AC}	
Accuracy V _{AC} @ 50/60 Hz	+/- (0.2% + 0.2V)	
Current	MN93	500 mA to 200 A _{AC}
	MN93A	5 mA to 100 A _{AC}
	C193	1 A to 1,000 A _{AC}
	AmpFlex® A193 & MiniFlex MA194	500 mA to 2,400 A _{AC}
Calculated measurements		
Ratios	Up to 25,000 A	
P, Q1, N, S, D power values	10 W to 10 MW / 10 var to 10 Mvar / 10 VA to 10 MVA	
Energy	Up to 4 EWh / 4 EVAh / 4 Evarh (E = 10 ⁻⁹)	
Phase	cos φ, tan φ, PF	
Harmonics	THD	
Additional functions		
Min / Max	Yes	
Mounting	Magnet	
Programmable storage interval	1 s to 1 hour (Min/Avg/Max)	
Recording modes	"Stop when full"	
Data storage	SD card, 8 GB (SD-HC card up to 32 GB)	
Recording duration	Depends on the SD card, programmable using the software	
Communication	USB, Wifi & Bluetooth	
Power supply	Via the phase, 90 V - 690 V @ 50-60 Hz	
Safety	IEC 61010 1000 V CAT III	
Mechanical specifications		
Dimensions	180 x 88 x 37 mm without sensor	
Weight	400 g	
Casing	IP54 (IEC 60529)	
Warranty	2 years	

⚙️ ACCESSORIES / REPLACEMENT PARTS

Carrying bag	P01298071
See all the accessories on page 105	

Don't forget to order your current sensors too: see page 104

PEL102 - PEL103 - PEL104

REF.: P01157152

REF.: P01157153

REF.: P01157154



SPECIFICATIONS

	PEL102	PEL103	PEL104
Display	None	With quadruple digital display	
Types of installations	Single-phase, split-phase, three-phase with or without neutral and many other specific configurations		
Number of channels	3 Voltage inputs, 3 Current inputs (calculated neutral current)		
Measurements			
Network frequencies	DC, 50 Hz, 60 Hz and 400 Hz		
Voltage (measurement ranges / best accuracy)	10.00 - 1,000 V _{AC} /bc		
Current (depending on sensors) (measurement ranges/ best accuracy)	5 mA _{AC} to 10 kA _{AC} / 50 mA _{BC} to 1.4 kA _{BC}		
Calculated measurements			
Ratio	Up to 650,000 V / up to 25,000 A		
Power	10 W to 10 GW / 10 var to 10 Gvar / 10 VA to 10 GVA		
Energy	Up to 4 EWh / 4 EVAh / 4 Evarh (E = 10 ¹⁸)		
Phase	cos φ, tan φ, PF		
Harmonics	THD		
Additional functions			
Phase sequence	Yes		
Min / Max	Yes		
Mounting	Magnet		
Logging			
Sampling rate / Acquisition interval / Aggregation	1 meas./s - 1 min to 60 min	5 meas./s - 1 min to 60 min	
Data storage	SD card, 8 GB (SD-HC card up to 32 GB)		
Communication	Ethernet, Bluetooth and USB	Ethernet, Bluetooth, USB, Wifi and GPRS	
Power supply	110 V - 250 V (+10 %, -15 %) @ 50-60 Hz & 400 Hz		
Safety	IEC 61010 600 V CAT IV and 1000 V CAT III		
Mechanical specifications			
Dimensions	256 x 125 x 37 mm without sensor		
Weight	900 g	950 g	900 g
Casing	IP54		

STRENGTHS

- Suitable for all types of cabinets and all Low Voltage electrical installations
- Implementation without powering down the electrical network
- Recording duration of several months or years
- Breakdown of energy losses
- Characterization of electric motors

CONTENTS

- **A PEL102 or PEL103 delivered with:**
1 carrying bag, 4 measurement leads (straight banana/straight banana 3 m long - black), 4 crocodile clips (black), 1 set of rings for the extremities of the leads and current sensors), 1 mains power cable, 1 x 8 GB SD card, 1 USB cable, 1 SD-USB adapter, PC software (PEL Transfer), 1 user's manual, 1 safety datasheet, 1 Quick Start Guide.
- **A PEL104 with:**
1 carrying bag, 4 voltage leads, 4 crocodile clips, PC software (PEL Transfer), 1 set of rings and inserts, 1 x 600V mains adapter, 1 SD card, 1 SD-USB adapter, 1 USB cable, 1 user's manual in multiple languages, 1 Quick Start Guide. Manual available for download from our website.

ACCESSORIES / REPLACEMENT PARTS

C193 clamp	P01120323B
MN93 clamp	P01120425B
MN93A clamp	P01120434B
E3N clamp	P01120043A
E3N adapter	P01102081
E27 clamp	P01120027
PAC93 clamp	P01120079B
J93 clamp	P01120110
AmpFlex® A193 clamp -450 mm	P01120556B
AmpFlex® A193 clamp -800 mm	P01120531B
MiniFlex MA194 clamp -250 mm	P01120593
MiniFlex MA194 clamp -350 mm	P01120592
MiniFlex MA194 clamp -1000 mm	P01120594
Mains power cable	P01295174
PEL100 mains adapter	P01102174
Leads/clamps kit (x4)	P01295476
Set of rings/inserts	P01102080
5 A adapter	P01101959
DataVIEW® software	P01102095
Bag no. 23	P01298078

PEL106

REF.: P01157165



STRENGTHS

- All-terrain IP67 casing resistant to shocks, UV light and high temperature
- Communication: Wifi, UMTS/GPRS, LAN (Ethernet network), Bluetooth and USB
- Self-powered via its voltage inputs up to - 1,000 V
- Continuous recording with a 200 ms acquisition interval
- Measurements in compliance with the IEEE 1459 standard
- 4 voltage inputs & 4 current inputs
- Ideal for implementation on an electricity pole

ADDITIONAL INFO

- The PEL106 is equipped with a quadruple digital display which is ideal for real-time power quality monitoring.

CONTENTS

- A **PEL106** with:
- 1 bag for the accessories
- 5 x IP67 leads
- 5 lockable crocodile clips
- 1 set of inserts and rings
- PC software (PEL Transfer)
- 1 SD card
- 1 SD-USB adapter
- 1 USB cable
- 1 user's manual in multiple languages
- 1 Quick Start Guide

SPECIFICATIONS

PEL106	
Display	With quadruple digital display
Types of installations	Single-phase, split-phase, three-phase with or without neutral and many other specific configurations
Number of channels	4 voltage inputs, 4 current inputs
Measurements	
Network frequencies	DC, 50 Hz, 60 Hz and 400 Hz
Voltage (measurement ranges / best accuracy)	10.00 - 1,000 V _{ac/dc}
Current (depending on sensors) (measurement ranges/ best accuracy)	5 mA _{ac} to 10 kA _{ac} / 50 mA _{dc} to 1.4 kA _{dc}
Calculated measurements	
Ratio	Up to 650,000 V / up to 25,000 A
Power	10 W to 10 GW / 10 var to 10 Gvar / 10 VA to 10 GVA
Energy	Up to 4 EWh / 4 EVAh / 4 Evarh (E = 10 ¹⁸)
Phase	cos φ, tan φ, PF
Harmonics	THD
Additional functions	
Phase sequence	Yes
Min / Max	Yes
Mounting	Hook (Opt.)
Analogue measurements	Up to 8 channels
Logging	
Sampling rate / Acquisition interval / Aggregation	5 meas./s - 1 min to 60 min
Data storage	SD card, 8 GB (SD-HC card up to 32 GB)
Communication	Ethernet, Bluetooth, USB, Wifi and GPRS
Power supply	Power supply via the phase - 1,000 V _{ac/dc}
Safety	IEC 61010 1000 V CAT IV
Mechanical specifications	
Dimensions	245 x 270 180 mm
Weight	<3,400 g
Casing	IP67

ACCESSORIES / REPLACEMENT PARTS

AmpFlex® A196 clamp -610 mm	P01120552
MiniFlex MA196 clamp -350 mm	P01120568
Leads kit (x 5) BB196	P01295479

See all the accessories on page 105

L411

REF.: P01157180



SPECIFICATIONS

	L411
Number of channels	1
Connection	MiniFlex (captive)
Current range	500 mA _{AC} to 3,000 A _{AC} ; @ 50/60 Hz
Accuracy (50/60 Hz)	0.1 to 100 A: ±(1 % R + 2 D) 90 to 400 A: ±(1 % R + 4 D)
Programmable storage interval	1 s to 1 hour (Min/Avg/Max)
Recording modes	"Stop when full"
Recording duration	Depends on SD card, programmable using the software
Display	Backlit LCD (blue)
	Real-time measurements
Data storage	SD / SD-HC / SD-XC
Wired communication	Optically-isolated USB 2.0
Wireless communication	Wifi (direct and router mode)
Power supply	3 x AA (or rechargeable) batteries; or via USB (Opt.)
Battery life	14 days' recording
Mechanical specifications	
Dimensions / weight	150 x 72 x 32 mm / 260g with batteries
Sensor size	Ø 70 / 250 mm (14"), with 1.20 m connection cable
Electrical safety	IEC 61010, 1000 V CAT III
Casing	UL-V1
Protection	IP54 (IEC 60529)
Warranty	2 years

STRENGTHS

- Stand-alone with captive sensor
- Alarm function
- Simplified use: magnetized, single connection without cutting the power supply; once parameterized, the measurements are performed independently and extraction to a PC is automatic.

ACCESSORIES / REPLACEMENT PARTS

DataView	P01102095
Shockproof sheath + Multiflex accessory	P01654252
Bag S03	P01298076

ADDITIONAL INFO

- Machine load monitoring
- Electrical troubleshooting, etc.

CONTENTS

- L411
- Safety datasheet
- Multilingual Quick Start Guide downloadable from our website
- USB cable
- USB mains adapter
- SD card

L412

REF.: P01157181



SPECIFICATIONS

	L412
Number of channels	2
Connection	Qualistar connection technology
Current range @ 50/60 Hz	400 mA _{AC} to 2,000 A _{AC} ; @ 50/60 Hz
A194/MA194	100 mA _{AC} to 1,200 A _{AC}
C193	1 A _{AC} to 1,000 A _{AC}
MN93A	5 mA _{AC} to 100 A _{AC}
MN93	100 mA to 200 A _{AC}
Accuracy (50/60 Hz)	Depends on sensor
Programmable storage interval	1 s to 1 hour (Min/Avg/Max)
Recording modes	"Stop when full"
Recording duration	Depends on SD card, programmable using the software
Display	Backlit LCD (blue)
	Real-time measurements
Data storage	SD / SD-HC / SD-XC
Wired communication	Optically-isolated USB 2.0
Wireless communication	Wifi (direct and router mode)
Power supply	3 x AA (or rechargeable) batteries; or USB (Opt.)
Battery life	14 days' recording
Mechanical specifications	
Dimensions / weight	150 x 72 x 32 mm / 260 g with batteries
Sensor size	Ø 350 mm (14"), with 1.20 m connection cable
Casing	UL-V1
Protection	IP54 (IEC 60529)
Warranty	2 years

STRENGTHS

- Split-phase measurement
- Stand-alone with secure connections
- Alarm function
- Wide range of current sensors

ADDITIONAL INFO

- Machine load monitoring
- Electrical troubleshooting, etc.

ACCESSORIES / REPLACEMENT PARTS

MA194-250 flexible current sensor	P01120593
MN93A current sensor	P01120434B
DataView software	P01102095
Shockproof sheath + Multifix accessory	P01654252
Bag S03	P01298076

CONTENTS

- L412
- Safety datasheet
- Multilingual Quick Start Guide downloadable from our website
- USB cable
- USB mains adapter
- SD card

L461

REF.: PO1157182

1000 V
CAT III

TRMS

Diagnostics
& testing

Education

Energy
efficiency

Transport

Tertiary
& residential

Industries

Generation,
transmission
& distributionLaboratory
& metrology

SPECIFICATIONS

	L461
Number of channels	1 (2 terminals)
Connection	4 mm banana plugs
Voltage range	
V _{AC} @ 50/60 Hz	100 mV _{AC} to 999.9 V _{AC}
V _{DC}	100 mV _{DC} to 1,499 V _{DC}
Accuracy	
V _{AC} @ 50/60 Hz	0.1 to 999.9 V: ±(1 % R + 5 D) 900 to 1,200 V: ±(1 % R + 1 D)
V _{DC}	0.1 to 999.9 V: ±(1 % R + 5 D) 900 to 1,500 V: ±(1 % R + 1 D)
Programmable storage interval	1 s to 1 hour (Min/Avg/Max)
Recording modes	"Stop when full"
Recording duration	Depends on the SD card, programmable using the software
Display	Backlit LCD (blue) Real-time measurements
Data storage	SD
Wired communication	Optically-isolated USB 2.0
Wireless communication	Wifi (direct and router mode)
Power supply	3 x AA (or rechargeable) batteries; or USB (Opt.)
Battery life	14 days' recording
Mechanical specifications	
Dimensions	235 x 102 x 41 mm
Weight (with batteries)	260 g
Electrical safety	IEC 61010, 1000 V _{AC} CAT III IEC 61010, 1500 V _{DC} CAT III
Casing	UL-V1
Protection	IP54 (IEC 60529)
Warranty	2 years

STRENGTHS

- Measurement up to 1,000 V_{AC} / 1,500 V_{DC}
- Power supply via the phase
- Alarm function
- Power supply by current sensor

ADDITIONAL INFO

- Machine load monitoring
- Electrical troubleshooting, etc.

CONTENTS

- L461
- Safety datasheet
- Multilingual Quick Start Guide
- C8 adapter
- 2 x 4 mm silicone banana leads for voltage
- 2 crocodile clips
- USB cable
- SD card

ACCESSORIES / REPLACEMENT PARTS

Carrying bag	P01298071
Shockproof sheath + Multifix accessory	P01654252

DL913 - DL914

REF.: P01157170 REF.: P01157171



STRENGTHS

- IP65 waterproof measuring instrument
- IRD server connection



SPECIFICATIONS

	DL913	DL914
Number of channels	3	4
Connection	24" MiniFlex (captive)	
Current range	100 mA _{AC} to 10,000 A _{AC} @ 50/60 Hz	
Accuracy (50/60 Hz)	± (1 % of reading + 4 D)	
Programmable storage interval	1 s to 1 hour (Min/Avg/Max)	
Recording modes	"Stop when full"	
Recording duration	Depends on SD card, programmable using the software	
Display	Backlit LCD (blue)	
	Real-time measurements	
Data storage	SD	
Wired communication	Optically-isolated USB 2.0	
Wireless communication	Wifi (direct and router mode)	
Power supply	Rechargeable NiMH batteries	
Battery life	14 days' recording	
Mechanical specifications		
Dimensions / weight	150 x 72 x 32 mm / 260g with batteries	
Sensor size	Ø 100 / 350 mm (14") length, with 1.20 m connection cable	
Electrical safety	IEC 61010, 1000 V CAT III	
Casing	UL-V1	
Protection	IP65 (IEC 60529)	

ADDITIONAL INFO

- Machine load monitoring,
- Electrical troubleshooting , etc.

CONTENTS

- DL913 or DL914
- Safety datasheet
- Multilingual Quick Start Guide downloadable from our website
- USB cable + European-format charger
- Verification certificate.

ACCESSORIES / REPLACEMENT PARTS

DataView	P01102095
Bag N°23 (option)	P01298078

L452

REF.: P01157201



STRENGTHS

- Process data logger with display
- 2 measurement channels
- Events counter
- Dry contact closure
- Detection of logic levels



SPECIFICATIONS

	L452			
	Measurement range	Resolution	Accuracy (% reading)	Sampling rate
DC current	4 to 20 mA ± 100 mV	0.01 mA ± 0.1 mV	0.05 mA (0.25 %) ± 0.1 mV (0.5 %)	5 samples/s
DC voltage	± 1 V ± 10 V	± 1 mV ± 10 mV	± 1 mV (0.5 %) ± 10 mV (0.5 %)	± 5 samples/s
Pulse	-	1 ms	-	-
Digital	-	1 ms	1 s (max. recording duration: 1 month)	-
Pulse voltage	3.3 V (with 1 000 000 Ωpull-up)			
Battery life in operation	200 ms acquisition with display On: 18 days 200 ms acquisition with display Off: 36 days 1 min acquisition with display Off: 270 days			
Power supply	110 to 240 V (50/60 Hz) – External: via USB connector Internal: 2.4 V rechargeable NiMH batteries (2 x 1.2 V)			
Recording modes	Start/Stop (stops when memory full or when campaign end date reached)			
Control	Local mode (multidirectional keypad on front panel) Remote mode (control via PC)			
Recording duration	10 minutes to 1 year, configurable			
Examples	2 channels @ 200 ms: 19 days 2 channels @ 1 min: > 1 year (theoretical)			
Acquisition interval	200 ms to 1 hour			
Communication	Bluetooth 2.1, class 1, USB 2.0			
Dimensions	32.4 x 65.5 x 125 mm (137.5 mm with screw connector)			
Weight	206 g			
Display	LCD 128 x 64 pixels			
Measurement terminal strip	6 screw terminals			
Operating temperature	0 to 50 °C			
Protection	IP42 (terminal strip IP20)			
Electrical protection	IEC 61010-1 Ed. 3 and IEC 61010-2-030 Ed. 1			

ADDITIONAL INFO

- To simplify use, the rear panel of the L452 is magnetized. You can also use the Multifix system or a wall-mount.

CONTENTS

- L452 logger
- 1 adapter and 1 µUSB power cable
- 1 CD-ROM containing the Datalogger Transfer software

ACCESSORIES / REPLACEMENT PARTS

µUSB power cable	P01102148
Screw connector kit (x 5)	P01295489
See all the accessories on page 105	

DATAVIEW®

REF.: PO1102095

- PAT
- PAT 2
- PAT 3
- PEL
TRANSFER
- DATA
LOGGER



FUNCTIONS

- Configuration of all the functions of instruments connected to a PC or via Bluetooth®
- Recovery of recorded measurement data
- Backup of measurement files
- Opening of saved files
- Processing and report creation (EN50160)
- Export into an Excel spreadsheet
- Export in .pdf format
- Database management

REQUIRED CONFIGURATION

- Windows Vista & Windows 7/8/10 (32/64 bit)
- 1 GB RAM for Windows Vista & Windows 7/8 (32 bit)
- 2 GB RAM for Windows Vista & Windows 7/8 (64 bit)
- 80 MB available hard-disk space (200 MB recommended)

ADDITIONAL INFO

- The Dataview® software:
- Automatically recognizes the instrument connected when it is hooked up to the PC and opens the corresponding menu. Users then have direct access to its configuration and the data stored on it
- Equipped with a large number of predefined report templates for quick generation in accordance with the applicable standards. Users can also create their own templates to meet their needs and directly add their own comments

PEL TRANSFER FOR PEL100

With the following **complementary functions**:

- Breakdown of the energy values to detect any losses
- Display of trend curves
- Current sensor inversion if set up incorrectly
- Configuration for GPRS communication

POWER ANALYZER TRANSFER 3 FOR CA 8345

With the following **complementary functions**:

- Display of events (transients, Inrush, Surge, etc.)
- Configuration of monitoring mode (EN50160)
- Configuration for communication with IRD server

POWER ANALYZER TRANSFER 2 FOR CA 8331 / CA 8336 AND CA 8333

The PAT 2 module of DataView® offers **complementary functions**:

- Configuration of alarms
- Configuration of transients
- Configuration of trend curves
- Real-time display
- Data recovery, backup and export
- Launch of measurement campaign after automatic configuration of the associated instrument.

DataView® modules	PAT	PAT 2	PAT 3	PEL TRANSFER	DATALOGGER
Related products	F407	CA 8331	CA 8345	PEL102	DL913
	F607	CA 8333		PEL103	DL914
	CA 8220	CA 8336		PEL104	L411
		CA 8436		PEL106	L412
				PEL51	L461
				PEL52	L452

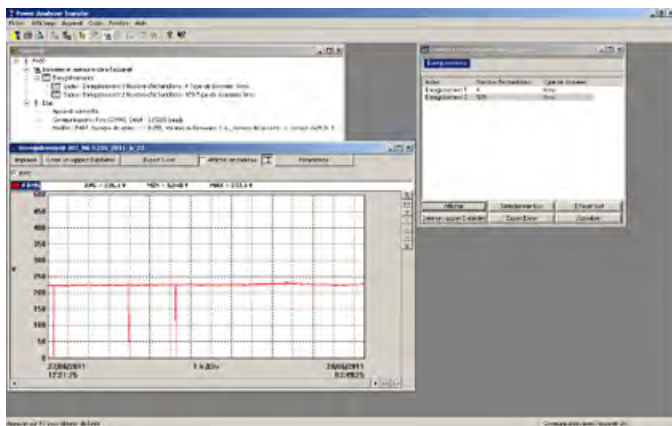

PAT MODULE Display of data stored by an F407 clamp

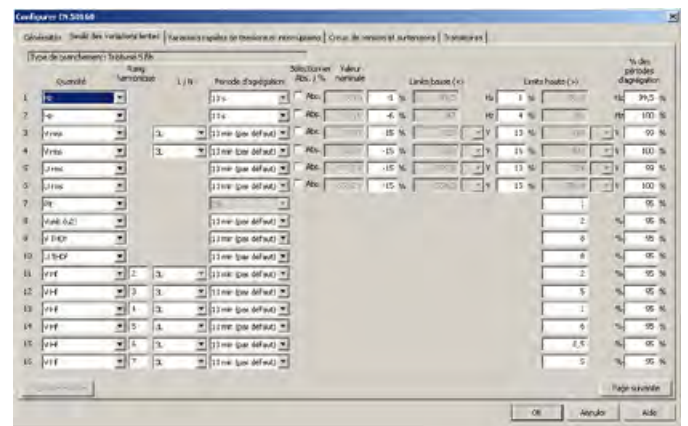

PAT 2 MODULE Configuration of EN 50160 parameters

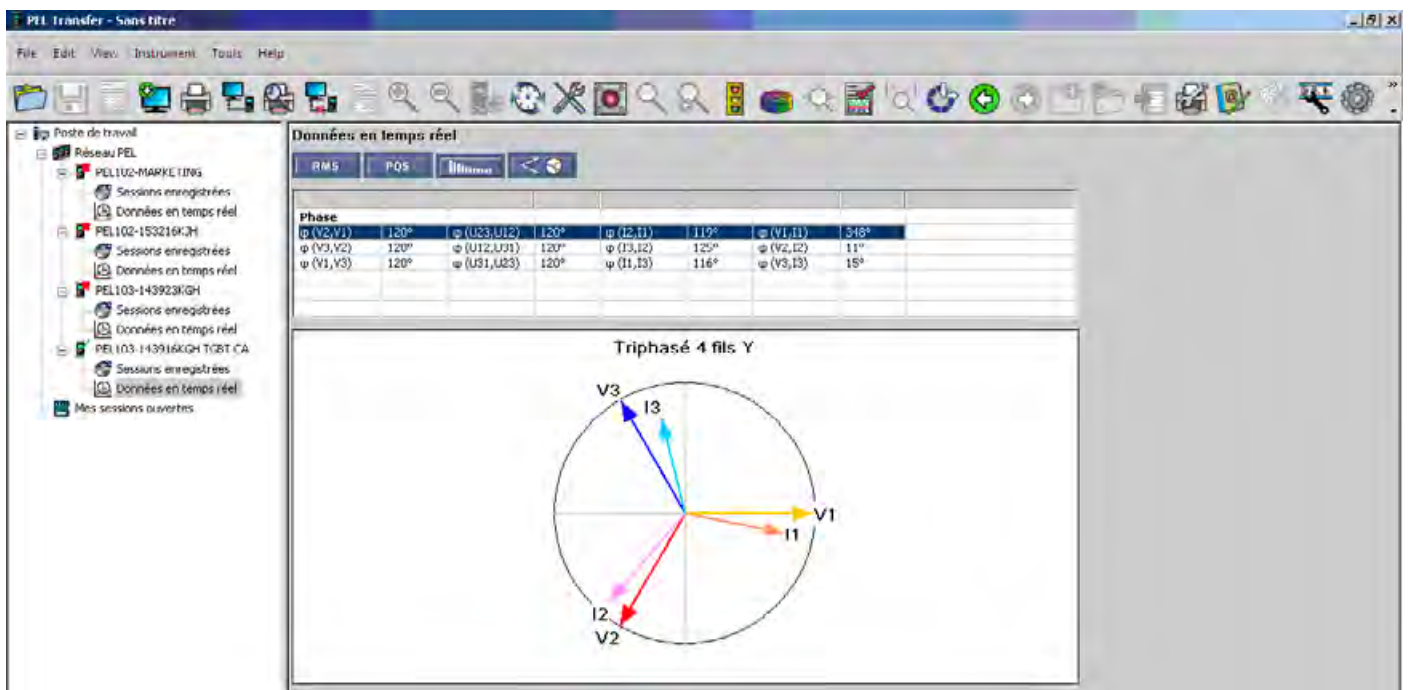

PEL TRANSFER MODULE Remote display of a vectorial representation

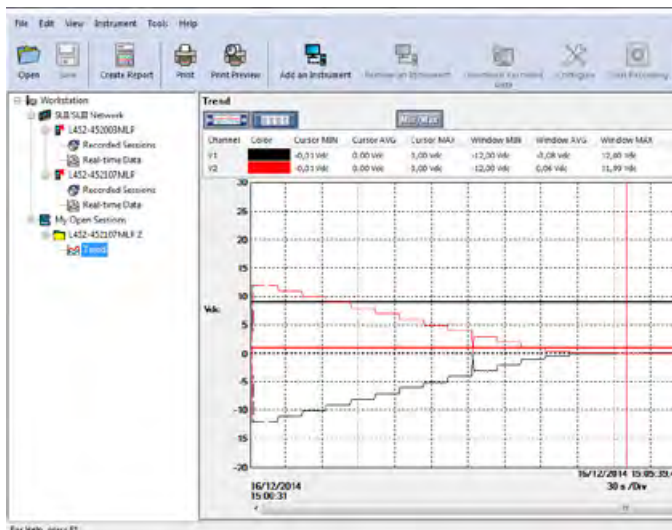



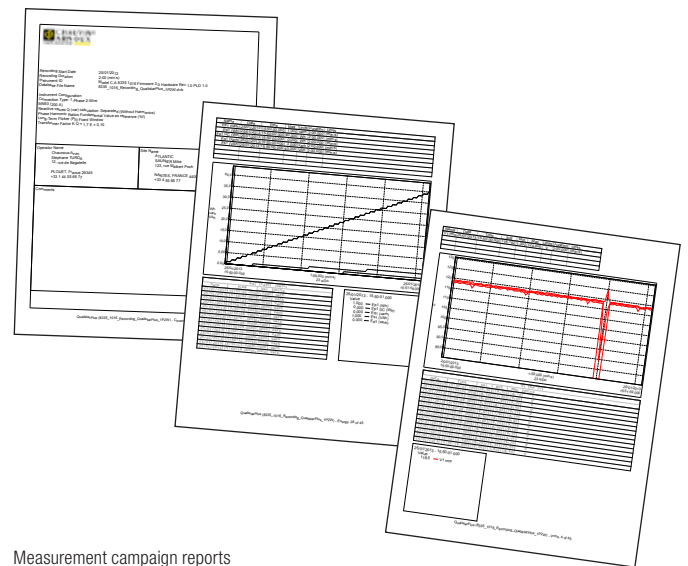

DATA LOGGER MODULE Recording of 0 - 10 V - 2 channels







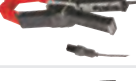



Measurement campaign reports

POWER AND ENERGY QUALITY ANALYSERS AND LOGGERS

CA 8220, CA 8331, CA 8333, CA 8336, CA 8436, PEL102, PEL103, PEL106 and PEL51, PEL52, L412
 Check the compatibility of the measurement ranges

	Model	Measurement range	Clamping diam. / Length	IEC 61010	Reference
CURRENT SENSORS	 MN93	500 mA to 200 A _{AC}	Ø 20 mm	600 V CAT III / 300 V CAT IV	P01120425B
	 MN 93A	5 mA to 100 A _{AC}	Ø 20 mm	600 V CAT III / 300 V CAT IV	P01120434B
	 MA194-250 MA194-350 MA194-1000 MA196-350	100 mA to 10 kA _{AC}	Ø 70/250 mm Ø 100/350 mm Ø 300/1.000 mm Ø 100 mm / 350 mm	1000 V CAT III / 600 V CAT IV	P01120593 P01120592 P01120594 P01120568
	 PAC93	1 A to 1,000 A _{AC} / 1 A to 1,300 A _{DC}	1 x Ø 39 mm or 2 x Ø 25 mm	600 V CAT III / 300 V CAT IV	P01120079B
	 J93	50 A to 3,500 A _{AC} / 50 A to 5,000 A _{DC}	Ø 72 mm	600 V CAT III / 300 V CAT IV	P01120110
	 A193-450 A196A-610	100 mA to 10 kA _{AC}	Ø 140 mm / 450 mm Ø 190mm / 610 mm	1000V CAT III / 600 V CAT IV 1000V CAT IV	P01120526B P01120554
	 A193-800	100 mA to 10 kA _{AC}	Ø 250 mm / 800 mm	1000 V CAT III / 600 V CAT IV	P01120531B
	 C193	1 A to 1,000 A _{AC}	Ø 52 mm	600 V CAT IV	P01120323B
	 E3N / E27	50 mA to 10 A _{AC/DC} 100 mA to 100 A _{AC/DC}	Ø 11,8 mm	600 V CAT III / 300 V CAT IV	P01120027

	Description	Reference
OTHER ACCESSORIES	 Kit of 5 banana leads + 5 crocodile clips + 1 set of coloured rings	P01295483
	 Kit of 4 banana leads + 4 crocodile clips + 1 set of coloured rings	P01295476
	 1 set of coloured inserts and rings	P01102080
	 5 A adapter unit	P01101959
	 Reeling box – Magnetized MultiFix cable winder	P01102149
	 USB-A USB-B cable	P01295293
	 Carrying bag no. 22	P01298056
	 DataView® software	P01102095
	 ESSAILEC unit	P01102131

ACCESSORIES / REPLACEMENT PARTS

POWER AND ENERGY QUALITY ANALYSER

CA 8220

- CA 1711 tachometer probe P01102082
- 2-wire Pt100 adapter HX0091
- E27 clamp adapter P01102081
- E27 clamp P01120027
- 230 V adapter with µUSB-B cable for E27 P01651023
- Bag no. 5 P01298049
- Crocodile clips (1 red/1 black) P01102057Z
- Banana/banana leads (1 red/1 black) P01295288Z
- Test probes (1 red/1 black) P01295454Z
- Pack of 6 NIMH rechargeable batteries P01296037
- CA 82X0 EUR mains power supply P01160640
- Optical/USB cable HX0056Z
- Current measurement lead P03295509
- PAC93 mains adapter P01101967
- DataView® software P01102095
- Set of 2 magnetized test probes (1 red / 1 black) P01103058Z
- RS232 / USB Adapter HX0055

THREE-PHASE POWER AND ENERGY QUALITY ANALYSER

CA 8331 / CA 8333 / CA 8336 / CA 8436

- Belt bag no. 21 P01298055
- Bag no. 22 P01298067
- Screen protection film P01102059
- In-vehicle charger HX0061
- E3N adapter P01102081
- E3N mains power pack P01120047
- Battery pack P01296024
- PA30W mains power pack (CA 8331-33-35-36) P01102057
- PA31ER mains adapter P01102150
- PAC93 mains adapter P01101967
- DataView® software P01102095
- ESSAILEC unit P01102131
- Reeling Box P01102149
- Set of colour-coded inserts/rigs P01102080
- IP 67 mains power cable (CA 8436) P01295477
- Set of caps (CA 8436) P01102117
- Set of 5 x 3 m IP67 banana cables P01295479
- Banana mains power cable (CA 8436) P01295496
- USB-A / USB-B cable P01295293
- 5 A box P01101959
- Set of 5 lockable crocodile clips P01102099
- Kit of 5 banana leads, 5 crocodile clips and 1 set of coloured rings P01295483
- Kit de 4 banana leads, 4 crocodile clips and 1 set of coloured rings P01295476

CA 8345

- PA32ER 1,000 V mains power pack P01103076
- PA40W-2 Li-Ion mains power pack P01102155
- C8 adapter P01103077
- Q2 bag P01298083
- SD card P01103078
- Magnetized hook P01103079
- E3N adapter P01102081
- E3N mains power pack P01120047
- PAC93 mains adapter P01101967
- DataView® software P01102095
- ESSAILEC unit P01102131
- Reeling Box P01102149
- Set of rings/inserts P01102080
- USB-A / USB-B cable P01295293
- 5 A box P01101959
- Kit of 5 banana leads, 5 crocodile clips and 1 set of coloured rings P01295483

POWER AND HARMONICS CLAMP MULTIMETER

F407, F607

- Set of red/black banana/banana leads P01295451Z
- Set of red/black crocodile clips P01295457Z
- Magnetized MultiFix kit P01102100Z
- Bluetooth kit P01637301
- Bag no. S03 P01298076
- DataView® software P01102095

POWER AND ENERGY LOGGER

PEL51 and PEL52

- Bag no. S03 P01298076
- Standard PVC cables with straight male 4 mm plugs P01295288Z
- 32 A crocodile clips P01102052Z
- DataView® software P01102095

PEL102 and PEL103 and PEL104

- Bag no. 23 P01298078
- E3N adapter P01102081
- Mains power cable P01295174
- Mains adapter (self-powering) P01102174
- PAC93 mains adapter P01101967
- DataView® software P01102095
- Kit de 4 banana leads, 4 crocodile clips and 1 set of coloured rings P01295476

PEL106

- Set of protective rubber plugs (5 small + 4 large) P01102147
- Pole-mounting kit P01102146
- Lockable crocodile clips kit (x5) P01102099
- E3N adapter P01102081
- Set of IP 67 banana leads 3 m long (x5) BB196 P01295479
- DataView® software P01102095
- Bag no. S21 P01298066
- PA30W mains power pack P01102057

CURRENT LOGGERS

L411 and L412

- DataView® software P01102095
- µUSB power cable P01102148
- Bag no. S03 P01298076

DL913 and DL914

- DataView® software P01102095
- Bag no.20 P01298078

VOLTAGE LOGGERS

L461

- 4 mm banana leads P01295288Z
- 32 A crocodile clips P01102052Z
- Bag no. S03 P01298076
- Type A-to-mini B USB cable 2 m long Please contact us
- Banana plug / female BNC adapter P01101846
- DataView® software P01102095
- µUSB power cable P01102148

PROCESS DATA LOGGER

L452

- DataView® software P01102095
- µUSB power cable P01102148
- Wall mount P01651024
- MultiFix mounting adapter P01102100Z
- Screw connector kit (x 5) P01295489

SOLAR POWER ANALYSER

FTV500

- FTV500 remote unit P01102184
- Inclinator P01102115
- Flexible test probes P01102189
- FTV 500 battery P01296052
- FTV 500 mains adapter P01295505
- Set of mc4 leads P01295504

INFO AND ADVICE
CALIBRATORS
THERMAL CAMERAS
THERMOMETERS

106
108
111
116

PH-METER **132**
CONDUCTIVITY METER **133**
OTHER PHYSICAL & ENVIRONMENTAL MEASURING INSTRUMENTS **123**
ACCESSORIES **135**

TEMPERATURE MEASUREMENT

Thermometers have always been essential instruments used by all industrial companies for:

- Ambient temperature measurement.
- Temperature monitoring in cold rooms and climatic chambers.
- Temperature measurement on walls/partitions
- Testing for hot spots in an electrical cabinet.
- Checking of foodstuff freshness by inserting a probe in the heart of the product

Chauvin Arnoux offers rugged, accurate, easy-to-use electronic thermometers:

- Thermocouple thermometers.
- Resistive probe thermometers.
- No-contact thermometers.
- Thermal cameras.

THERMOCOUPLES

The operating principle of thermocouples is based on the **electromotive force created naturally between two conductor wires of different materials joined at the end** (SEEBECK effect). This electromotive force depends on the temperature to which one of the two junctions is exposed. This temperature is measured as a voltage of a few millivolts. A thermocouple is therefore composed of two junctions (or welds) linking two different metals or alloys. One of the junctions, positioned at the point of measurement, is called the hot junction, while the other is called the cold junction and its known temperature serves as the reference. For two given materials or alloys, there is a relation between the electromotive force and the reference and measurement temperatures. This

relation is usually **expressed** by a characteristic curve of **sensitivity in mV/°C**.

RESISTIVE PROBES

Some pure metals have a coefficient of resistivity which varies as a function of temperature in a reproducible way. The metals generally used are platinum and copper. Currently, the widest-used type is platinum, with a resistance of 100 Ω at 0 °C.

OPTICAL OR NO-CONTACT MEASUREMENTS

All bodies emit electromagnetic radiation whose spectrum has an energy distribution which is a function of temperature.

This measurement system offers **quick temperature testing on parts which are current-carrying, moving or difficult to access**. It can also be used for measurements of very high temperatures or on poor heat conductors such as ceramics or synthetic materials.

CHOOSING THE RIGHT TEMPERATURE MEASUREMENT SYSTEM

Three types of measurement are used to measure temperature:

- Measurement by penetration (semi-solids, pasty samples, etc.) and by immersion (liquids).
- Ambient measurement (air, gas).
- Surface measurement (solid bodies).

For the latter type, users can choose a system with or without contact, depending on the application involved. The type of application will determine the instrument and the probe chosen.

In general, thermocouples offer quick response times and wide measurement ranges. Sensors with resistive probes are usually slower, but they are also more accurate.

The sensor selection criteria will depend on:

- the milieu and the operating environment.
- the temperature range.
- the required accuracy.
- the response time.



INFRARED THERMOGRAPHY

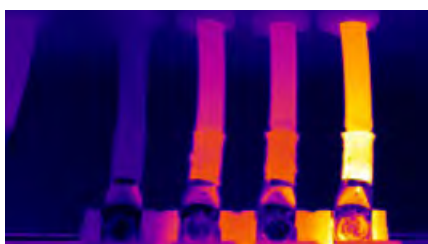

Infrared thermography detection technology has become irreplaceable for ensuring safe conditions for industrial production. Infrared thermal imaging is a no-contact, real-time inspection method for production equipment subject to high voltages, powerful electric currents or high operating speeds.

For this detection method, there is no need to cut off the current, shut down the machines or stop production. It can be used to troubleshoot any latent malfunctions in advance and thus prevent failures and avoid production incidents. Thermal imaging is an innovative technique for safe, reliable and quick "no-contact" assessment. A thermal camera does not measure temperatures but radiation fluxes. Once the operator has adjusted certain parameters, the camera calculates the temperatures of the target. It then provides the user with a map of the temperatures, called a thermogram: each temperature is represented by a different colour.

ELECTRICAL MAINTENANCE

The purpose of this sort of inspection is to detect any overheating in working electrical systems due to various causes: poor connections, overloads, phase unbalance, faulty contacts, etc. This helps to prevent and avoid costly equipment damage, production shutdowns, operating losses, fires, etc.

The aim is to help with decision-making for corrective action, to prevent incidents, to anticipate any works which might be necessary and to facilitate electrical installation maintenance (time saving and safety).

MECHANICAL MAINTENANCE

Moving mechanical parts heat up quite normally due to friction. Infrared thermography reveals abnormal overheating due to wear, misalignment, lubrication problems, etc.

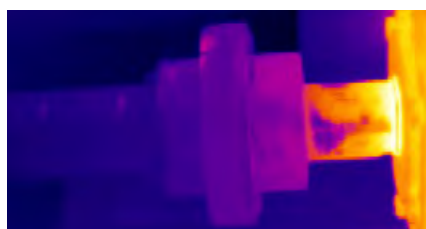

It is used to complement vibratory analysis, which is much more time-consuming to set up. A single image gives a full health report on the electric motor, its power supply (cables), the bearings and, if necessary, the alignment.

BUILDING THERMICS

These applications of infrared thermography concern architects, heating and sanitary installers, heating operators, electricians, property companies, property experts, owners and insurers.

With an infrared camera, it is easy to view the distribution of heat on the front of a building and it also possible to precisely locate heat losses due to faulty insulation. This helps to produce a thermal survey of the building.

PHYSICAL & ENVIRONMENTAL MEASUREMENTS

INDOOR AIR QUALITY

Whether in places open to the public (transport, administrative offices, schools, hospitals), professional buildings or private areas, our lifestyles mean we spend most of our time inside buildings. Human activity and construction, decoration and furnishing products (paints, floor and wall coverings, varnishes, etc.) are all potential sources of contamination and emit substances in the air. The theme of indoor air quality has only recently come into the spotlight and is a major issue because it affects the whole population.

CARBON DIOXIDE (CO₂)

Carbon dioxide is an odourless, colourless, toxic gas produced by the combustion of carbon-based materials such as wood, oil, coal and their derivatives. It is also produced by human and animal respiration. Plants, meanwhile, extract CO₂ from the air during photosynthesis, thus helping to maintain the natural equilibrium.

However, the level of CO₂ in outdoor air has shown a tendency to increase gradually. This gradual increase began with industrialization and the development of human activity (combustion of fossil fuels).

WHY MEASURE IT?

In indoor environments, the CO₂ measurement represents the level of confinement, a sign of pollutant accumulation and insufficient air renewal in the premises. Links have been revealed between poor ventilation, leading to high levels of CO₂, and a reduction in the educational capabilities of children tested with logic, reading and calculation exercises.

A CO₂ concentration in the air of more than 1,000 ppm can already cause the people in a room to suffer from somnolence, difficulties concentrating and sometimes headaches.

THRESHOLD VALUES

In volume terms, the proportion of CO₂ in the air is 0.0375%, or 375 ppmv (parts per million by volume). In urban environments, it may be as high as 500 ppm.

- 5500 to 1,000 ppm - Indoor air quality: Good
- 1,000 ppm - Certain studies have shown an increase in asthma-related symptoms among children on average over a school day
- 1,500 to 2,500 ppm - Indoor air quality: Poor (1,500 ppm is the regulatory limit usually specified, particularly for educational premises in the United Kingdom, Germany and Austria)
- 2,500 to 5,000 ppm - Symptoms: headache, fatigue and loss of concentration
- 5,000 ppm - Average concentration over 8 hours - Occupational Exposure Limit in France and elsewhere



MEASUREMENT PRINCIPLE

The method used by the CA 1510 to measure CO₂ levels is an NDIR (Non-Dispersive InfraRed) method. CO₂ and other gases absorb IR radiation in a "specific" way.

- A source emits an IR signal in a predefined cavity
- The CO₂ absorbs part of the light in the near-IR spectrum, thus reducing the intensity of the signal

SENSOR POSITIONING AND RECOMMENDATIONS

The measuring instrument should preferably be positioned between 50 cm and 2 m from the ground. In practice, it should be set up in a safe place with access to a power socket if necessary.

The instrument should be kept at least 50 cm away from any intense heat sources (heating) and should be kept out of direct sunlight. The instrument must not be placed in the direct flow of air from outside (windows) or close to the entrance. The CO₂ level varies during the day, depending on how many people are present, the activities involved and the efficiency of the air renewal system; for these reasons, functions for recording and for indicating any threshold overruns are crucial.

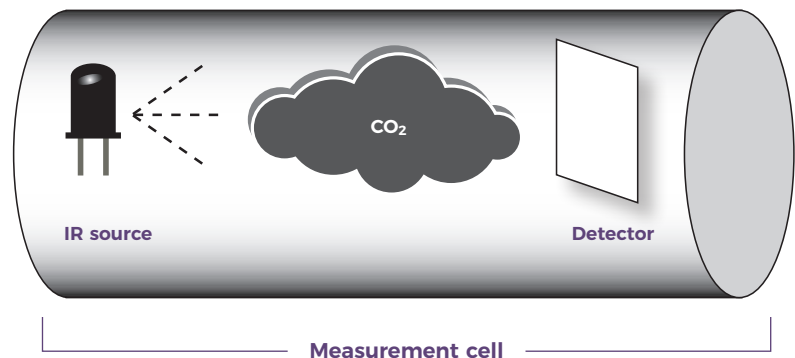

CHOOSE YOUR CALIBRATOR



	CA 1621 page 109	CA 1623 page 109	CA 1631 page 110
Measurement / Simulation			
J, K, T, E, R, S, B & N thermocouples	■		
Pt10, Pt50, Pt100, Pt200, Pt500 & Pt1000 resistive probes		■	
4-20 mA			■
0-10V			■
Voltage			
Up to 100 mV	■		■
Up to 20 V			■
Current			
Up to 24 mA			■
Resistance			
0.00 to 3200.0 Ω		■	

CA 1621 - CA 1623

REF.: PO1654621

REF.: PO1654623



★ STRENGTHS

- Large screen for easier reading
- Instrument calibration without removing the sensors
- Good grip due to its (205x97x45 mm) and weight (472 g)

CA 1621: thermocouple sensor temperature calibrator capable of measuring and simulating:

- up to 8 types of thermocouple: J, K, T, E, R, S, B and N
- a voltage in mV

CA 1623: resistive probe temperature sensor capable of measuring and simulating:

- up to 7 types of resistive probes: Pt 10, Pt 50, Pt 100, Pt 200, Pt 500, Pt 1000, Pt 100 (JIS)
- a resistance

⚙️ SPECIFICATIONS

CA 1621		
Input/output range	Resolution	Accuracy
-10 mV ... 100 mV	0.01 mV	± 0.025 % + 2 counts

Function	Range	Resolution	Accuracy	Reference junction error
Type J	-200 ... +1,200 °C	0.1 °C	± (0.3 °C + 10 µV)	± 0.3 °C
Type K	-200 ... +1,370 °C	0.1 °C	± (0.3 °C + 10 µV)	± 0.3 °C
Type T	-200 ... +400 °C	0.1 °C	± (0.3 °C + 10 µV)	± 0.3 °C
Type E	-200 ... +950 °C	0.1 °C	± (0.3 °C + 10 µV)	± 0.3 °C
Type R	-20 ... +1,750 °C	1 °C	± (1 °C + 10 µV)	± 0.3 °C
Type S	-20 ... +1,750 °C	1 °C	± (1 °C + 10 µV)	± 0.3 °C
Type B	+600 ... +1,800 °C	1 °C	± (1 °C + 10 µV)	± 0.3 °C
Type N	-250 ... +1,300 °C	0.1 °C	± (0.3 °C + 10 µV)	± 0.3 °C

CA 1623			
Range	4-wire measurement accuracy ± Ω	Simulation accuracy ± Ω	Admissible excitation in mA
0.00 Ω ... 400.0 Ω	0.1	0.15	0.1 ... 0.5
		0.1	0.5 ... 3.0
400.0 Ω ... 1500.0 Ω	0.5	0.5	0.05 ... 0.8
1500.0 Ω ... 3200.0 Ω	1	1	0.05 ... 0.4
	2		

Mode	Range	Accuracy in °C			Admissible excitation in mA
		4-wire input	2-wire /3-wire input	Output	
Pt10 385	-200 ... +800 °C				0.1 ... 3.0
Pt50 385	-200 ... +800 °C	0.7	1.0	0.7	0.1 ... 3.0
Pt100 385	-200 ... +800 °C	0.33	0.5	0.33	0.1 ... 3.0
Pt200 385	-200 ... +250 °C	0.2	0.3	0.2	0.1 ... 3.0
	+250 ... +630 °C	0.8	1.6	0.8	
Pt500 385	-200 ... +500 °C	0.3	0.6	0.3	0.05 ... 3.0
	+500 ... +630 °C	0.4	0.9	0.4	
Pt1000 385	-200 ... +100 °C	0.2	0.4	0.2	0.1 ... 3.0
	+100 ... +630 °C	0.2	0.5	0.2	
Pt100 JIS	+200 ... +630 °C	0.2	0.5	0.3	0.1 ... 3.0

+ ADDITIONAL INFO

- Power supply via mains lead available as an option:
- Input: 100 V/240 V - 50/60 Hz – 1.8 A
- Output: 12 Vdc, 2 A max
- Powered by batteries (6 x 1.5 V supplied) or via mains lead (option)

📦 CONTENTS

- 1 calibrator
- 1 soft case
- 6 x 1.5 V LR06 batteries
- **CA 1621** delivered with 2 thermocouple adapters as well
- **CA 1623** delivered with 2 test cables and 2 crocodile clips as well

🔧 ACCESSORIES / REPLACEMENT PARTS

Mains power supply	P01103057
Pre-equipped MultiFix bag 120x245x60	P01298075
See all the accessories on page 136	

CA 1631

REF.: PO1654402



★ STRENGTHS

Voltage/current process signal calibrator to measure or provide:

- a 0 – 24 mA DC current loop
- a 0-20 V DC voltage loop

⚙️ SPECIFICATIONS

CA 1631		
Range	Resolution	Accuracy ± (% of reading + counts)
100 mV	0.01 mV	0.02 % + 3
20 V	0.001 V	0.02 % + 3
Input impedance: 2 MΩ (rated value), < 100 pF Protection against overvoltages: 30 V – Current delivered at 20 V: 1 mA		
Range	Resolution	Accuracy ± (% of reading + counts)
24 mA	0.001 mA	0.015 % + 3
Protection against overvoltages: 125 mA 250 V quick-response fuse Display as percentage: 0 % = 4 mA 100 % = 20 mA Source mode: 1,000 Ω load at 20 mA for a battery voltage ≥ 6.8 V, (700 Ω at 20 mA for a battery voltage between 5.8 and 6.8 V) Simulation mode: external loop voltage condition: 24 V (rated value), 30 V maximum, 12 V minimum.		
Loop voltage supply: 24 V ± 10 %		

⊕ ADDITIONAL INFO

- Power supply via mains lead available as an option:
- Input: 100 V/240 V - 50/60 Hz – 1.8 A
- Output: 12 V_{DC}, 2 A max
- Powered by 6 x 1.5 V batteries (supplied) or via mains power cable (option)

📦 CONTENTS

- 1 calibrator
- 1 soft case
- 6 x 1.5 V LR06 batteries
- 2 test cables
- 2 crocodile clips
- 2 test probes

⚙️ ACCESSORIES / REPLACEMENT PARTS

Mains power supply	P01103057
MultiFix bag 120x245x60 mm	P01298075
See all the accessories on page 136	

CA 1900

REF.: PO1651902



★ STRENGTHS

- **ACCURACY:** less than 0.5 °C
- **FAST:** instantaneous temperature detection
- **NO CONTACT:** measurement from up 1.5 metres away
- **AUDIBLE AND VISUAL ALERTS:** doe any abnormally high temperature
- **ALARMS:** fixed threshold or threshold based on the average of the people tested
- **PRACTICAL:** tripod insert beneath the camera

📦 CONTENTS

The CA 1900 thermal camera is delivered in a site-proof case with:

- 4 NiMH batteries and battery charger
- 1 micro SD HD card
- 1 USB cable
- 1 Bluetooth earpiece
- 1 test report
- 1 quick start guide



⚙️ SPECIFICATIONS

		CA 1900
Detector		160 x 120
Type		UFPA microbolometer, 8 ~14 µm
Frequency		9 Hz
Sensitivity (N.E.T.D)		60 mK @ 30 °C (0.06 °C @ 30 °C)
Measurement fluctuation		< 0.02 °C (with adaptive alarm)
Temperature measurement		
Temperature range		+30 °C to +45 °C
Accuracy		± 0.5 °C @ 37 °C
Thermal imaging performance		
Field of view		38° x 28°
IFOV (spatial resolution)		4.1 mrad
Focusing		Fixed
Minimum focal distance		30 cm
Real image		Yes (320 x 240 pixels)
Display mode		Thermal image, real image
Analysis functions		
Measuring tools		1 manual cursor + 1 automatic hot spot detection function + Isotherm
Alarms		- Adaptive alarm based on a temperature difference compared with the average of the temperatures measured (up to 6 people) - Alarm on overrun of a temperature threshold set by the operator - Visual and audible indications of overruns (via the Bluetooth earpiece supplied) - Compatibility with Bluetooth hands-free kits or loudspeakers (profiles supported: HSP, HFP)
Data storage		On removable 2 GB micro SD card (approx. 4,000 images), up to 32 GB possible
Image format		.png (thermal and real images saved simultaneously)
Image presentation		
Adjustment		Automatic or manual adjustment of the palette min. and max.
Image hold		Animated or fixed image
Image display		Multiple palettes including high-contrast rainbow or black and white
Screen		2.8 inches
Power supply		
Type		NiMH rechargeable batteries with low self-discharge
Recharging mode		External (charger supplied)
Battery life		9 hours (in normal conditions of use)
Environmental specifications		
Operating temperature		-15 °C to +50 °C (-4 °F to +122 °F)
Storage temperature range		-40 °C to +70 °C (-40 °F to +158 °F)
Humidity		10 % to 95 %
Compliance		EN 61326-1: 2006 / EN 61010-1 Ed. 2
Fall resistance		2 metres on all surfaces
Shock resistance		25 G
Vibration withstand		2 G
Physical specifications		
Weight / Dimensions		700 g with rechargeable batteries / 225 x 125 x 83 mm
Interfaces		- USB link and Mass Storage function: the product is then recognized as a USB key for easy image transfer - Bluetooth for connectivity with earpiece
Mounting on tripod		Yes, ¼" insert on the camera
General information		
Warranty		2 years

CA 1950

REF.: PO1651901



SPECIFICATIONS

	CA 1950
Detector	80 x 80
Type	UFPA microbolometer, 8 ~14 µm
Frequency	9 Hz
Sensitivity (N.E.T.D)	80 mK @ 30 °C (0.08 °C @ 30 °C)
Temperature measurement	
Temperature range	-20 °C to +250 °C
Accuracy	±2 °C or ±2 % of the reading
Imaging performance (thermal image)	
Field of view	20° x 20°
IFOV (spatial resolution)	4.4 mrad
Focusing	Fixed
Minimum focal distance	40 cm
Real image	Yes (320 x 240 pixels)
Display mode	Thermal imaging, real image with automatic parallax compensation. Image merge function available in the PC software
Analysis functions	
Measuring tools	1 manual cursor + 1 automatic detection function + Min Max on adjustable area + temperature profile + Isotherm
Parameter settings	Emissivity, environmental temperature, distance, relative humidity
Voice comments	Yes via Bluetooth (earpiece supplied)
Connectivity	F407 & F607 clamps, MTX 3292, MTX 3293
Data storage	On removable 2 GB micro SD card (approx. 4,000 images), up to 32 GB possible
Image format	.bmp (thermal and real images saved simultaneously)
Image presentation	
Adjustment	Automatic or manual adjustment of palette min-max
Image hold	Animated or fixed image
Image display	Multiple palettes
Screen	2.8 inches
Power supply	
Type	NiMH rechargeable batteries with low self-discharge
Recharging mode	External (charger supplied)
Battery life	13 hrs 30 mins (typical) / 50 % brightness, Bluetooth deactivated
Environmental specifications	
Operating temperature	-15 °C to +50 °C (-4 °F to +122 °F)
Storage temperature range	-40 °C to +70 °C (-40 °F to +158 °F)
Humidity	10 % to 95 %
Compliance	EN 61326-1: 2006 / EN 61010-1 Ed. 2
Resistance to falls	2 metres on all surfaces
Shock resistance	25 G
Vibration withstand	2 G
Physical specifications	
Weight / Dimensions	700 g with rechargeable batteries / 225 x 125 x 83
Ingress protection	IP 54
Interfaces	- USB link and Mass Storage function: the product is then recognized as a USB key for easy image transfer - Bluetooth for connectivity with earpiece (voice comments) and Chauvin Arnoux® Metrix® measuring instruments (F407, F607, MTX 3292, MTX 3293)
Mounting on tripod	Yes, ¼" insert on camera
General information	
Report generation software	Supplied as standard with automatic report generation in .pdf or .docx (Word) format / Compatibility with W7, W8, 32 and 64 bits
Warranty	2 years

★ STRENGTHS

- Battery life of up to 13 hours, start-up in just 3 seconds
- Resistance to falls from up to 2 m without interrupting operation
- Focus-free with 20° x 20° field of view
- Voice annotations to record comments directly on the image (earpiece supplied)
- Connectivity with current clamps and multimeters

+ ADDITIONAL INFO

- Thermal image and real image saved simultaneously. Image merge function available with the CAmReport software supplied
- Numerous measuring tools: manual cursor, automatic detection, temperature profile, etc.
- Built-in brightness sensor

📦 CONTENTS

CA 1950 delivered in site-proof case with:

- 4 NiMH batteries
- 1 battery charger
- 1 x 2 GB micro SD HD card
- 1 USB cable
- 1 Bluetooth earpiece
- 1 CD-ROM containing the CAmReport software
- 1 measurement report



CA 1954

REF.: P01651904

IP 54
160 x 120



PNG











★ STRENGTHS

- **Unprecedented !** Battery life of up to 9 hours in continuous use
- Resistance to falls from up to 2 m without interrupting operation
- Focus-free with 38° x 28° field of view
- Recovery of the data from other measuring instruments (current, humidity, dew point, etc.)
- Practical: voice recording, integrated user-enhanceable emissivity table, folder organization by site

+ ADDITIONAL INFO

- Thermal image and real image saved simultaneously. Image merge function available in the CAmReport software supplied
- Numerous measuring tools: manual cursor, automatic detection, temperature profile, etc.
- Built-in brightness sensor

📦 CONTENTS

CA 1954 delivered in a site-proof case with:

- 4 NIMH batteries
- 1 battery charger
- 1 x 2 GB micro SD HD card
- 1 USB cable
- 1 Bluetooth earpiece
- 1 CD-ROM containing the CAmReport software
- 1 measurement report



⚙️ SPECIFICATIONS

CA 1954	
Detector	160 x 120
Type	UFPA microbolometer, 8 ~14 µm
Frequency	9 Hz
Sensitivity (N.E.T.D)	80 mK @ 30 °C (0.08 °C @ 30 °C)
Temperature measurement	
Temperature range	-20 °C to +250 °C
Accuracy	±2 °C or ±2 % of the reading
Imaging performance (thermal image)	
Field of view	38° x 28°
IFOV (spatial resolution)	4.1 mrad
Focusing	Fixed
Minimum focal distance	30 cm
Real image	Yes (320 x 240 pixels)
Display mode	Thermal image, real image with automatic parallax compensation. Image merge function available in the PC software
Analysis functions	
Measuring tools	1 manual cursor + 1 automatic detection function + Min Max Avg on adjustable area + temperature profile + Isotherm
Parameter settings	Emissivity, environmental temperature, distance, relative humidity
Voice comments	Yes via Bluetooth (earpiece supplied)
Connectivity	CA 1821/22/23, CA 1246, CA 1227, F407, F607, MTX 3292, MTX 3293
Data storage	On removable 2 GB micro SD card (approx. 4,000 images), up to 32 GB possible
Image format	.png (thermal images and real images saved simultaneously)
Laser pointer	Yes
Presentation of the image	
Adjustment	Automatic or manual adjustment of palette min-max
Image hold	Animated or fixed image
Image display	Multiple palettes
Screen	2.8 inches
Power supply	
Type	NiMH rechargeable batteries with low self-discharge
Recharging mode	External (charger supplied)
Battery life	9 hours (typical) / 50 % brightness, Bluetooth deactivated
Environmental specifications	
Operating temperature	-15 °C to +50 °C (-4 °F to +122 °F)
Storage temperature range	-40 °C to +70 °C (-40 °F to +158 °F)
Humidity	10 % to 95 %
Compliance	EN 61326-1: 2006 / EN 61010-1 Ed. 2
Resistance to falls	2 metres on all surfaces
Shock resistance	25 G
Vibration withstand	2 G
Physical specifications	
Masse	700 g with rechargeable batteries
Dimensions	225 x 125 x 83 mm
Indice de protection	IP 54
Interfaces	- USB link and Mass Storage function - Bluetooth for connectivity with earpiece (CA 1821/22/23, CA 1246, CA 1227, F407, F607, MTX 3292, MTX 3293)
Montage sur trépied	Yes, 1/4" insert on camera
General information	
Report generation software	Supplied as standard with automatic report generation (.pdf / .docx) Compatibility with W7, W8, W10, 32 and 64 bits
Warranty	2 years

CAmReport



★ STRENGTHS

- Dedicated to the CA 1950 and CA 1954 models
- Supplied as standard at no extra cost
- Complete, with all the necessary functions for reliable analysis of your measurement results
- Automatic generation of analytical reports exportable in word or pdf format

🎯 PRECISE ANALYTICAL TOOLS

- Cursors (automatic display of the temperature at the chosen point)
- Thermal profile (automatic display of the Min/Max/Avg temperatures on the line)
- A square or circle for analysis by zone
- Polygons and polylines for more precise analysis of certain areas of the thermogram
- Result tables quickly and automatically display all the information
- Recovery of the voice comments or online measurements
- Automatic merging of the thermal and real images saved simultaneously
- Automatic report creation for export in .pdf or .docx format

🌐 LANGUAGES AVAILABLE

French, English, German, Spanish, Italian, Dutch, Polish, Romanian, Czech, simplified Chinese, Portuguese, Swedish, Finnish

💻 REQUIRED CONFIGURATION

WINDOWS XP:

- SP3 minimum
- 850 MB memory for 32 bit
- 2 G for 64 bit
- NET Framework 4.0 minimum
- Monitor resolution: super VGA (800 x 600) or higher

WINDOWS VISTA / 7 / 8 / 10:

- SP1 minimum
- 850 MB memory for 32 bit
- 2 G for 64 bit
- NET Framework 4.0 minimum

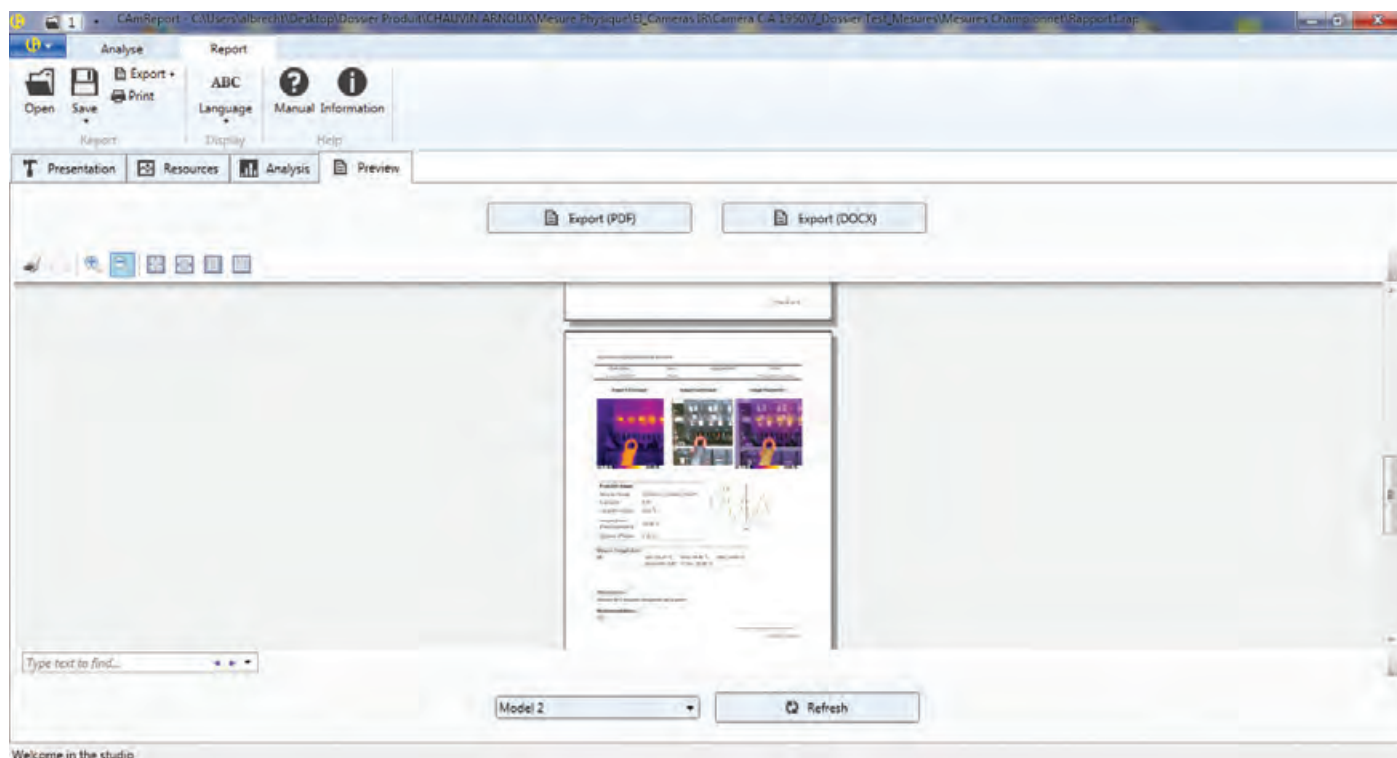
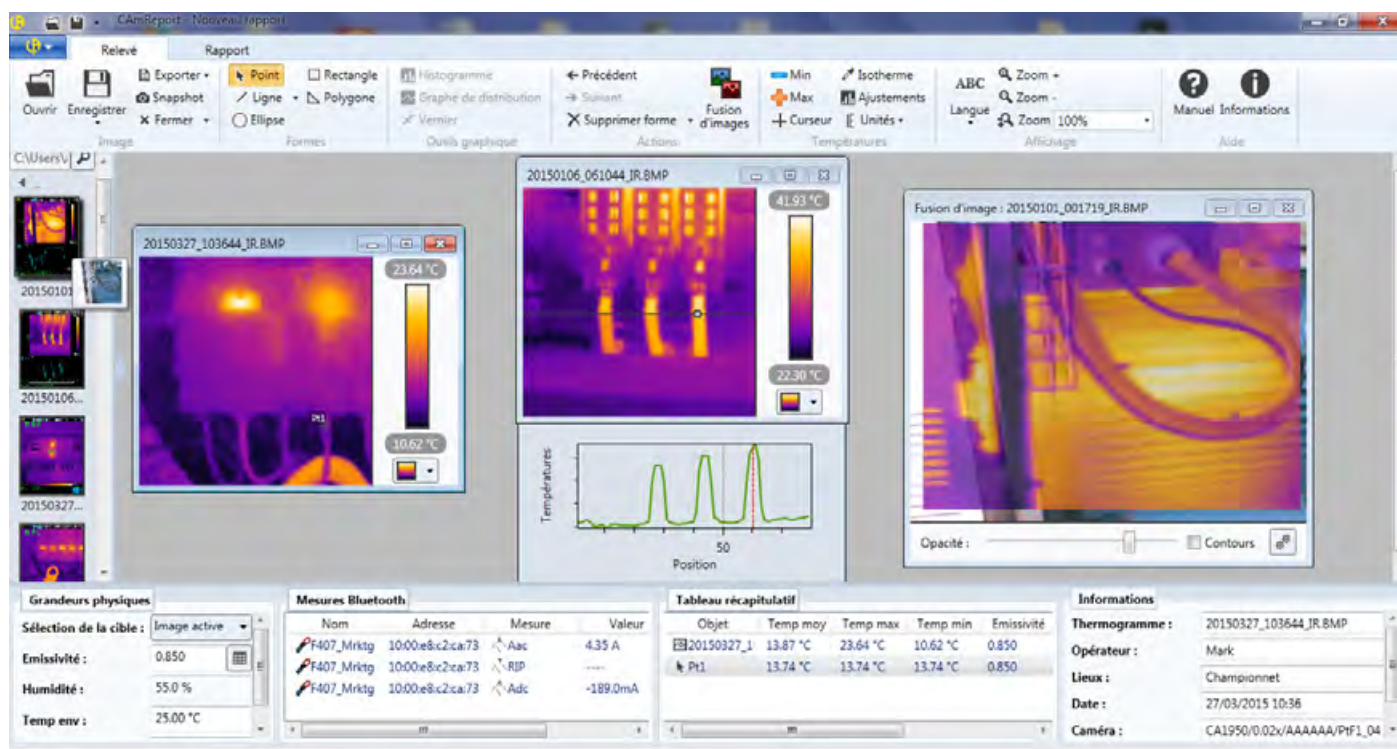

- Reports are generated automatically according to various templates available.
- They can be exported in Word or pdf format. This makes it simpler to print and archive.

CHOOSING YOUR THERMOMETER



	CA 1871	CA 1860	CA 1862	CA 1864	CA 1866	CA 876	CA 1821	CA 1822	CA 1823	TK 2000	TK 2002
	page 118	page 117	page 117	page 117	page 117	page 118	page 120	page 120	page 121	page 119	page 119
Infrared measurement											
	■	■	■	■	■	■					
Field of view											
8/1	■										
10/1		■				■					
12/1			■								
30/1				■							
50/1					■						
Emissivity											
Fixed: 0.95	■	■									
Variable: 0.1 to 1			■	■	■	■					
Laser sight	■	■	■ Double	■	■	■					
Contact measurement											
1-input thermocouple sensor						■	J, K, T, N, E, R, S	J, K, T, N, E, R, S		K	K
2-input thermocouple sensor								J, K, T, N, E, R, S			K
1-input resistive probe									Pt100 Pt1000		
General functions											
HOLD	■	■	■	■	■	■	■	■	■	■	■
Max		■	■	■	■	■	■	■	■		
Min		■	■	■	■	■	■	■	■		
Avg		■	■	■	■		via Data Logger Transfer	via Data Logger Transfer	via Data Logger Transfer		
Alarm		■	■	■	■	■	■	■	■		
Choice of units	■	■	■	■	■	■	■	■	■		
Backlighting	■	■	■	■	■	■	■	■	■		

CA 1860 - CA 1862

REF.: PO1651815

REF.: PO1651816



- IP 65
- 3 m
- °C
- °F
- IR



★ STRENGTHS

- Compact and rugged thanks to its resistance to falls from up to 3 metres and IP65 ingress protection
- Excellent metrological performance
- Wide dynamic range for measurement: -35 °C to +650 °C
- Double LASER sight (CA 1862) for precise targeting of the test area
- Parameterizable high and low alarms

⚙️ SPECIFICATIONS

	CA 1860	CA 1862
Measurement range	- 35 °C to + 450 °C (- 31 °F to + 842 °F)	- 35 °C to + 650 °C (- 31 °F to + 1202 °F)
Measurement accuracy	≥ 0° C: ± 1.8 °C or ± 1.8 % of reading (take the higher value) < 0 °C: ± (1.8 °C + 0.1 °C / °C)	
Display resolution	0.1 °C (0.1 °F)	
Field of view	10: 1	12: 1
Emissivity	0.95	Adjustable from 0.1 to 1.0
Response time	250 ms (95 % of reading)	
Spectral response	8 μm ~14 μm	
Number of lasers	Single laser	Double laser
Measurement functions	Instantaneous mode, MAX, MIN, AVG, differential (DIF), continuous measurement by blocking the measurement trigger, alarms	
Type of battery	9V battery (6F22)	
Protection	IP65	
Resistance	Falls from 3 metres	
Tripod insert	Yes	
Weight/dimensions	292 g / 189 mm x 118 mm x 55 mm	

📦 CONTENTS

- The **CA 1860** and **CA 1862** are delivered with:
- 1 carrying bag
 - 1 x 9 V LR14 battery

CA 1864 - CA 1866

REF.: PO1651813

REF.: PO1651814



- °C
- °F
- IR

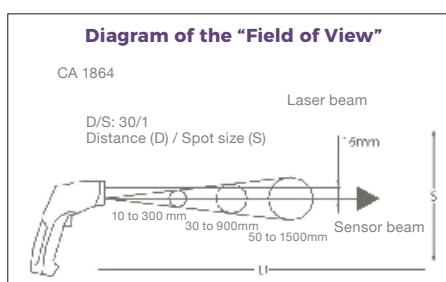

★ STRENGTHS

- Extended temperature range: measure up to 1,000 °C
- Use the variable emissivity to perform your inspections in accordance with reality
- High distance/spot ratio for better accuracy at long distances
- Set your alarm thresholds so that you are alerted every time there is an abnormal temperature!

⚙️ SPECIFICATIONS

	CA 1864	CA 1866
Field of view	30/1	50/1
Emissivity	0.1 to 1	
Measurement range	- 50 °C to +1000 °C	
Resolution	0.1 °C	
Accuracy	- 50 °C to - 20 °C: ± 5 °C - 20 °C to +200 °C: ±1.5 % R + 2 °C +200 °C to +538 °C: ±2.0 % R + 2 °C +538 °C to +1000 °C: ±3.5 % R ± 5 °C	
Functions	Max., Min., Avg., DIFF, HOLD	
Alarms	High and low	
Measurement unit	°C, °F	
Laser sight	Yes, Class II laser	
Display	20,000 counts, backlighting	
Dimensions / weight	230 x 100 x 56 mm / 290 g	

🔧 ACCESSORIES / REPLACEMENT PARTS

9 V LR14 battery	P01100620
Soft case	P01298033

📦 CONTENTS

- The **CA 1864** and **CA 1866** are delivered with:
- 1 carrying bag
 - 1 x 9 V LR14 battery

CA 1871

°C IR

REF.: PO1651610Z



★ STRENGTHS

- Infrared probe suitable for use with all multimeters
- Point the probe at the surface of the object.
The sensor supplies a voltage proportional to the temperature measured (1 mV / °C)

⚙️ SPECIFICATIONS

	CA 1871
Field of view	8/1
Emissivity	Fixed 0.95
Measurement range	- 30 °C to + 550 °C
Accuracy	± 2 % of reading
Dimensions / weight	164 x 50 x 40 mm / 182 g

📦 CONTENTS

- The CA 1871 is delivered with:
- 1 x 9V LR14 battery

CA 876

°C °F IR

REF.: PO1651403Z



★ STRENGTHS

- Rugged thanks to their shockproof protective sheath
- Temperature measurement up to 1,350 °C
- Measurement accuracy
- Stability of the sensor over time
- Infrared measurement possible

⚙️ SPECIFICATIONS

	CA 876	
	IR measurement	Contact measurement
Field of view	10/1	-
Emissivity	0.1 to 1	-
Measurement range	- 20 °C to + 550 °C	- 40 °C to + 1,350 °C
Accuracy	± 2 % R or ± 3 °C	± 0.1 % R + 1 °C
Functions	Max., Min., Avg., HOLD, Alarms	
Dimensions / weight	173 x 60.5 x 38 mm / 255 g	

📦 CONTENTS

- 1 shockproof sheath
- 1 flexible K thermocouple sensor

⚙️ ACCESSORIES / REPLACEMENT PARTS

K thermocouples	page 134
CK extensions	page 135

TK 2000 - TK 2002

REF.: P01653100

REF.: P01653110



★ STRENGTHS

- Compact, accurate and simple to use: just connect the sensor and start measuring!
- Usable in all environments thanks to their IP 65 protection
- Measures the temperature difference by means of the 2 thermocouple inputs on the TK 2002

⚙️ SPECIFICATIONS

	TK 2000	TK 2002
No. of inputs	1	2
Range	- 50 °C to +1000 °C	
Accuracy	± 1.5 % + 0.5 °C	
Functions	HOLD, °C	
Dimensions	163 x 63 x 37.5 mm	
Weight	200 g	

📦 CONTENTS

- 1 battery
- TK 2000** delivered with:
- 1 flexible K thermocouple sensor
 - 1 x 9 V 6LR61 battery
- TK 2002** delivered with:
- 2 flexible K thermocouple sensors
 - 1 pile 9 V 6LR61

⚙️ ACCESSORIES / REPLACEMENT PARTS

K thermocouples	page 134
CK extensions	page 135

CA 1821 - CA 1822

REF.: PO1654821

REF.: PO1654822



★ STRENGTHS

- J, K, T, N, E, R, S thermocouples
- Recording of up to 1 million points
- Magnetized product compatible with MultiFix
- USB and Bluetooth communication
- Backlit digital display

⚙️ SPECIFICATIONS

	CA 1821	CA 1822
Sensor	J, K, T, N, E, R or S thermocouple	
No. of inputs	1	2
Range	J: 210 to + 1,200 °C / 346 to + 2,192 °F K: 200 to + 1,372 °C / 328 to + 2,501 °F T: 250 to + 400 °C / 418 to + 752 °F N: 200 to + 1,300 °C / 328 to + 2,372 °F E: 150 to + 950 °C / 238 to + 1,742 °F R 0 to + 1,767 °C / 32 to + 3,212 °F S 0 to + 1,767 °C / 32 to + 3,212 °F	
Resolution	Display in °C: $\theta < 1,000$ °C: 0.1 °C and $\theta \geq 1,000$ °C: 1 °C Display in °F: $\theta < 1,000$ °F: 0.1 °F and $\theta \geq 1,000$ °F: 1 °F	
Accuracy	(J, K, T, N, E) $\theta \leq - 100$ °C $\pm (0.2\% \text{ Reading} + 0.6^\circ\text{C})$ $- 100^\circ\text{C} < \theta \leq + 100^\circ\text{C} \pm (0.15\% \text{ R} + 0.6^\circ\text{C})$ $+ 100^\circ\text{C} < \theta \pm (0.1\% \text{ R} + 0.6^\circ\text{C})$ (R, S) $\theta \leq + 100^\circ\text{C} \pm (0.15\% \text{ R} + 1.0^\circ\text{C})$ $+ 100^\circ\text{C} < \theta \pm (0.1\% \text{ R} + 1.0^\circ\text{C})$	
Functions	Min., Max., HOLD, alarms, temperature differential (CA 1822)	
Recording	Manual Start / Stop on the product Programmed recording	
Alarms	Visual alert on threshold overrun set via Data Logger Transfer Recording can be triggered on alarm threshold	
Data storage	More than 1 million points	
Power supply	- 3 x 1.5V LR6 alkaline batteries or NiMH rechargeable battery - Mains connection possible with the mains / micro USB adapter (option)	
Battery life	1,000 hrs (portable mode) / 3 years for recording (15-minute measurement interval)	
Dimensions/weight	150 x 72 x 32 mm / 260 g with batteries	
Ingress protection	IP54 casing	
Operating temperature / humidity	-10 to +60 ° C - 10 to 90 % RH	
Standards	IEC 61010-1 - IEC 61326-1	

+ ADDITIONAL INFO

- Shockproof sheath available as an accessory
- Compatible with the Data Logger Transfer module of the Dataview® software for:
 - data display
 - programming of recordings
 - automatic export of the report

📦 CONTENTS

CA 1821 and CA 1822 delivered with:

- 1 carrying bag
- 3 x 1.5 V LR6 batteries
- 1 USB cable
- 1 measurement report



🔧 ACCESSORIES / REPLACEMENT PARTS

Thermocouple	page 134
Shockproof sheath + MultiFix accessory	P01654252
CK extensions	page 135
See all the accessories on page 136	

CA 1823

REF.: P01654823



★ STRENGTHS

- Pt100 or Pt1000 resistance probe
- Recording of up to 1 million points
- MultiFix-compatible magnetized product
- USB and Bluetooth communication
- Backlit digital display

⚙️ SPECIFICATIONS

	CA 1823
Sensor	Pt100 or Pt1000 probe
No. of inputs	1
Range	-100 to +400 °C -148 to +752 °F
Resolution	Display in °C: 0.1°C Display in °F: 0.1°F
Accuracy	± (0.4 % R + 0.3 °C)
Functions	Min., Max., HOLD, Alarms
Recording	Manual Start / Stop on the product Programmed recording
Alarms	Visual alert on threshold overrun set via Data Logger Transfer Recording can be triggered on alarm threshold
Data storage	More than 1 million points
Power supply	3 x 1.5V LR6 alkaline batteries or NIMH rechargeable battery Mains connection possible with the mains / micro USB adapter (option)
Battery life	800 hours (portable mode) / 3 years for recording (15-minute measurement interval)
Dimensions/weight	150 x 72 x 32 mm / 260 g with batteries
Ingress protection	IP54 casing
Operating temperature / humidity	-10 to +60 °C - 10 to 90 % RH
Standards	IEC 61010-1 for 50 V voltages in Category II - IEC 61326-1



ADDITIONAL INFO

- Shockproof sheath available as an accessory
- Compatible with the Data Logger Transfer module of the Dataview® software for:
 - data display
 - programming of recordings
 - automatic export of the report



CONTENTS

CA 1823 delivered with:

- 1 carrying bag
- 3 x 1.5 V LR6 batteries
- 1 USB cable
- 1 measurement report



ACCESSORIES / REPLACEMENT PARTS

Thermocouples	page 134
Shockproof sheath + MultiFix accessory	P01654252
CK extensions	page 135

See all the accessories on page 136

CA 1246

REF.: PO1654246



★ STRENGTHS

- Hygrometry, temperature and dew point
- Recording up to 1 million points
- Visual alarm on threshold overrun
- MultiFix-compatible magnetized product
- Recording trigger on alarm threshold



⚙️ SPECIFICATIONS

	CA 1246
RH range	3 to 98 % RH
RH accuracy	10 to 90 %RH: $\pm (2 \%RH \pm 1 \text{ ct})$ outside that range: $\pm (4 \%RH \pm 1 \text{ ct})$
Temp. range °C/°F	-10 to +60 °C +14 to +140 °F
Temp. accuracy °C/°F	10 to 40°C: $\pm (0.5^\circ\text{C} \pm 1 \text{ ct})$ outside that range: $\pm (0.032 \times (T-25) \pm 1 \text{ ct})$ / T=temperature in °C
Dew point range	-10 to +60 °Ctd -4 to +140 °Ftd
Dew point accuracy	1.5 °C from 20 % RH to 30 % RH 1 °C above 30 % RH
Functions	Min., Max., HOLD, Alarms
Recording	Manual Start / Stop on the product Programmed recording
Alarms	Visual alert on threshold overrun set via Data Logger Transfer Recording can be triggered on alarm threshold
Data storage	More than 1 million points
Power supply	3 x 1.5V AA / LR6 alkaline batteries or NiMH rechargeable battery Mains connection possible with the mains / micro USB adapter (option)
Battery life	1,000 hrs (portable mode) / 3 years for recording (15-minute measurement interval)
Dimensions / weight	187 x 72 x 32 mm / 260 g with batteries
Ingress protection	IP54 casing
Operating temperature / humidity	-10 to +60 °C / 10 to 90 % HR
Standards	IEC 61010-1 - IEC 61326-1

+ ADDITIONAL INFO

- Compatible with the Data Logger Transfer module of the Dataview® software for:
 - data display
 - programming of recordings
 - automatic export of the report

📦 CONTENTS

CA 1246 delivered with:

- 1 carrying bag
- 3 x 1.5 V LR6 batteries
- 1 USB cable
- 1 measurement report



⚙️ ACCESSORIES / REPLACEMENT PARTS

75 % salt cartridge	P01156401
33 % salt cartridge	P01156402
See all the accessories on page 136	

CA 847

REF.: PO1156302Z



★ STRENGTHS

- Measure the humidity of wood very simply: prick the material and note the value corresponding to the LED which lights up.



⚙️ SPECIFICATIONS

	CA 847
RH range	6 to 100 % HR
RH accuracy	$\pm 1 \text{ LED}$
Dimensions	173 x 60.5 x 38 mm
Weight	160 g

📦 CONTENTS

The CA 847 is delivered with 1 x 9 V 6LR61 battery

CA 1227

REF.: P01654227



★ STRENGTHS

- Temperature, air speed and air flow rate
- Mapping of measured air speeds (MAP mode)
- Min, Max, Average and Hold functions
- Recording up to 1 million points

⚙️ SPECIFICATIONS

CA 1227	
Air speed / flow rate sensor	Rotating vane with optical detection
Air speed range	0.25 m/s to 35.0 m/s (49.0 to 6890.0 fpm)
Air speed accuracy	± 3 % of reading ± 4 cts
Air flow rate range	0 to 2,999 m³/h
Air flow rate accuracy	± 8 % of reading
Temp. range °C/°F	- 20 to +50 °C / - 4 to +122 °F
Temp. accuracy °C	0 to 50 °C: ± 0.8 °C -20 to 0 °C: ± 1.6 °C
Functions	Min., Max., HOLD, Average
Recording	Manual Start / Stop on the product Programmed recording
Data storage	More than 1 million points
Power supply	- 3 x 1.5V LR6 alkaline batteries or NiMH rechargeable battery - Mains connection possible with the mains / micro-USB adapter offered as an accessory
Battery life	200 hrs (portable mode) / 8 days of recording (measurements at 15-minute intervals)
Dimensions	Casing: 150 x 72 x 32 mm Sensor: 160 x 80 x 38 mm Spiral cable: 24 to 120 cm
Weight	Approx. 400 g
Ingress protection	IP40 casing
Operating temperature / humidity	-10 to +60 °C / 10 to 90 % HR
Standards	IEC 61010-1 - IEC 61326-1

⊕ ADDITIONAL INFO

- Compatible with the Data Logger Transfer module of the Dataview® software for:
 - data display
 - programming of recordings
 - automatic export of the report

📦 CONTENTS

- CA 1227 delivered with:
- 1 carrying bag
 - 3 x 1.5 V LR6 batteries
 - 1 USB cable
 - 1 measurement report



⚙️ ACCESSORIES / REPLACEMENT PARTS

Cones kit for flow-rate measurement with rotating vane (circular cross-section Ø 210mm and rectangular cross-section 346x346mm)	P01654250
Vane sensor Ø 80 mm	P01654251

See all the accessories on page 136

CA 850 - CA 1550

REF.: P01184101

REF.: P01654550



★ STRENGTHS

- Accurate and simple to use
- Time/date-stamped monitoring
- Differential measurements

⚙️ SPECIFICATIONS

	CA 850	CA 1550
Measurement range	-6.89 to +6.89 bar	- 2,450 to + 2,450 Pa
Accuracy	0.5 % at full scale	
Unit	psi, bar, mbar, mmH2O, inH2O kbar, cmH2O, FtH2O, mmHg, OZin², kg/cm² Pa, PSI, DaPa, hPa, mbar, mmHg, inHg, mmH2O, inH2O m/s et km/h, fpm et mph m³/s, m³/h, l/s ou cfm	
Functions	Differential measurements, Min., Max., HOLD	
Dimensions	182 x 72 x 30 mm	150 x 72 x 32 mm
Weight	220 g	260 g

📦 CONTENTS

- CA 850 delivered with:
- 1 hard case
 - 2 connection tubes
 - 1 x 9 V 6LR61 battery

- CA 1550 delivered with:
- 1 carrying bag
 - 3 x 1.5 V AA alkaline batteries
 - 2 transparent connection hoses,
 - 1 USB cable
 - 1 test report and Quick Start Guide

⚙️ ACCESSOIRES / RECHANGES

Pitot tube (length 324 mm, Ø 6 mm fitting, Ø at tube mouth 8 mm)	P01654560
Transparent hose (Internal Ø 5 mm, length 2 metres)	P01654561

CA 832

REF.: PO1185501Z

dBa dBc



★ STRENGTHS

- Sound level testing
- Simple to use



⚙️ SPECIFICATIONS

	CA 832
Measurement range	37.0 to 130.0 dB
Frequency range	31.5 Hz to 8 kHz
Accuracy (in reference conditions at 94 dB, 1 kHz)	± 2 dB
Frequency weighting	A / C
Time weighting	FAST: 125 ms / SLOW: 1 second
Function	

Measurement modes MaxL (Maximum sound level)

Leq (equivalent continuous sound level) integration time -

Recording -

Display Digital

Physical specifications

Tripod insert Yes

Dimensions / weight 237 x 60.5 x 38 mm (230 g)

General specifications

Compliance IEC 651 type 2

Warranty 2 year

Software No

📦 CONTENTS

CA 832 delivered with:

- 1 shockproof sheath
- 1 jack socket for analogue output
- 1 universal adapter for mounting on tripod
- 1 x 9 V 6LR61 battery

CA 1310

REF.: PO1651030

dBa dBc



★ STRENGTHS

- Measurement of the equivalent continuous sound level (Leq)
- Recording of up to 64,000 measurement points with data processing software supplied as standard
- Wide backlit screen with digital and bargraph display
- Microphone for remote use (extension accessory)



⚙️ SPECIFICATIONS

	CA1310
Measurement range	30.0 to 130.0 dB
Frequency range	20 Hz to 8 kHz
Accuracy (in reference conditions at 94 dB, 1 kHz)	± 1 dB
Frequency weighting	A / C
Time weighting	FAST:125 ms / SLOW: 1 second
Function	

Measurement modes SPL (Sound Pressure Level)
Leq (Equivalent Continuous Sound Level)
MaxL (Maximum Equivalent Sound Level)
MinL (Minimum Sound Level)

Leq (equivalent continuous sound level) integration time Available values:
10 sec, 1 min, 5 min, 10 min, 15 min, 30 min, 1 h, 8 h, 24 h

Recording 64 000 points

Display Digital and bargraph
Time/date-stamping

Physical specifications

Tripod insert Yes

Dimensions / weight 262 x 75 x 39 mm / 390 g

General specifications

Compliance IEC 61672-1 Class 2

Warranty 2 years

Software SL-Software:
- Values displayed in graph or table format
- Data export
- Real-time mode

📦 CONTENTS

CA 1310 delivered in a hard case with:

- batteries
- foam wind shield
- software on CD-Rom
- 1 male jack socket
- user's manual
- verification certificate

CA 1110

REF.: P01654110



★ STRENGTHS

- Totally compliant lighting measurement in all directions
- Measures up to 200,000 lux
- Mapping of lighting measured for an area or room (MAP mode)
- Metrological compensation on Fluo LEDs.
- Min., Max., Avg. and HOLD
- Recording up to 1 million points

⚙️ SPECIFICATIONS

	CA 1110
Measurement range	0.1 to 200 000 lx 0.01 to 18 580 fc
Accuracy in standard mode	
Incandescent lamp	± 3 % of reading
LED	± 6 % of reading (3,000 K to 6,000 K)
Fluorescent lamp	± 9 % of reading
Accuracy in compensation mode	
LED mode	± 4 % of reading (at 4000 K)
Fluo mode	± 4 % of reading (type F11, 4000 K)
Functions	Min., Max., HOLD, Average
Recording	Manual Start / Stop on the product Programmed recording
MAP mode	The MAP function can be used to map the lighting on a surface or in a room. In this way, the lighting measurements are saved in the same file.
Data storage	More than 1 million points
Power supply	- 3 x 1.5V AA / LR6 alkaline batteries or NIMH rechargeable battery - Mains connection possible with the mains / micro USB adapter (option)
Battery life	500 hours (portable mode) / 3 years of recording (15-minute measurement interval)
Dimensions	Casing: 150 x 72 x 32 mm Sensor: 67 x 64 x 35 mm (with protective cover) Spiral cable: 24 to 120 cm
Weight	345 g with batteries
Ingress protection	Casing IP50
Operating temperature / humidity	-10 to +60 ° C / 10 to 90 % RH
Standards	Class C as per the NF C 42-710 standard

⊕ ADDITIONAL INFO

- Compatible with the Data Logger Transfer module of the Dataview® software for:
 - data display
 - programming of recordings
 - automatic export of the report

⚙️ ACCESSORIES / REPLACEMENT PARTS

Shockproof sheath + MultiFix accessory	P01654252
Mains adapter	P01651023
See all the accessories on page 136	

📦 CONTENTS

- CA 1110 delivered with:
- 1 carrying bag
 - 3 x 1.5 V LR6 batteries
 - 1 USB cable
 - 1 measurement report



CA 1725 - CA 1727

REF.: P01174810

REF.: P01174830



★ STRENGTHS

- Measurements up to 100,000 RPM
- Measurement with and without contact
- Multiple functions available: rotation speed, linear speed, counting, frequency, period
- Possibility of programming and storage capacity

CA 1727

- USB connection to process the recordings on PC with the CA 1727

⚙️ SPECIFICATIONS

	CA 1725	CA 1727
RPM function		
Range	60 to 100,000 rpm	
Accuracy	10 ⁻⁴ of reading ± 6 cts	
m/min function		
Range	60 to 10,000 m/min.	
Accuracy	10 ⁻⁴ of reading ± 1 increment	
Hz function		
Range	1 to 10,000 Hz	
Accuracy	4 x 10 ⁻⁵ of reading ± 4 cts	
ms functions		
Range	0.1 to 1000 ms	
Accuracy	10 ⁻⁴ of reading ± 5 cts	
Duty cycle function		
Range	0.1 to 100 %	
Accuracy	0.1 % to 1 %	
Counting function		
Range	-	0 to 100,000 events
Accuracy	-	± 1 event
Functions	Min., Max., HOLD, Smooth	
	-	High and low alarms
Data storage	-	4,000 points
Dimensions	21 x 72 x 47 mm	
Weight	250 g	

⚙️ ACCESSORIES / REPLACEMENT PARTS

Mechanical accessories kit	P01174902
End-fittings (set of 3)	P01174903

See all the accessories on page 136

📦 CONTENTS

CA 1725 delivered with:

- 1 hard case
- 1 FRB F connector
- 1 x 9 V LR14 battery
- 1 set of 15 strips of reflective tape (0.1 m long)
- 1 CD-ROM containing the user's manual

CA 1727 delivered with:

- 1 hard case
- 1 FRB F connector
- 1 x 9 V LR14 battery
- 1 set of 15 strips of reflective tape (0.1 m long)
- 1 CD-ROM containing the TACHOGRAPH software



CDA 9452

Flashes /min

REF.: P03197704



★ STRENGTHS

- Frequency or speed measurement without contact with rotating parts
- Digital frequency display
- Quartz time base
- White flash lamp, 40 joules

⚙️ SPECIFICATIONS

	CDA 9452
LED display	10,000 counts
Measurement range	100... 1,000 flashes/min 1,000... 10,000 flashes/min
Resolution	1 flash/min
Accuracy	0.05 %
Power supply	220 V – 50/60 Hz
Climatic conditions	0... + 50 °C / RH < 80 %
Dimensions	210 x 120 x 120 mm
Weight	1 kg

+ ADDITIONAL INFO

- When the flashes from the stroboscope are directed at an object moving periodically and have the same frequency as the phenomenon observed, the object appears immobile. All you then need to do is read the frequency expressed in flashes/minute on the CDA 9452. To obtain the frequency in Hz, simply divide the reading by 60.

📦 CONTENTS

CDA 9452 delivered with mains power cable

CA 895

ppm CO

REF.: P01651001Z



★ STRENGTHS

- Measures the level of carbon monoxide present in a room
- Checks the operation of combustion equipment
- Warning buzzer to indicate when there is a risk

⚙️ SPECIFICATIONS

	CA 895
Measurement range	0 to 1,000 ppm
Accuracy	± 5 % + 5 ppm
Measurement mode	Normal or Avg.
Functions	Alarm, Max., HOLD
Dimensions	237 x 60.5 x 38 mm
Weight	190 g

📦 CONTENTS

CA 895 delivered with:

- 1 shockproof protective sheath
- 1 x 9V LR14 battery

⚙️ ACCESSORIES / REPLACEMENT PARTS

Aspiration kit with pump and extension

P01651101

CA 1510

REF.: PO1651011



SPECIFICATIONS

CA 1510	
Specifications for CO₂	
Measurement range	0 to 5,000 ppm
Accuracy	± 50 ppm ± 3% of measured value
Resolution	1 ppm
Temperature measurement	
Measurement range	-10°C to +60°C
Accuracy	± 0.5 °C
Resolution	0.1°C
Humidity	
Measurement range	5 to 95 % RH
Accuracy	± 2% RH
Resolution	0.1% RH
Possibilities of the product	
Portable measurement	Quick measurement and display of the CO ₂ , temperature and relative humidity values
Indicator	1D mode: CO ₂ confinement indication Visual indication (two-colour backlighting and pictograms) and/or audible indication of high confinement when the CO ₂ concentration is between 1,000 ppm and a 1,700 ppm threshold. 3D mode: indication of optimum comfort zone on the basis of hygrothermal criteria and the CO ₂ concentration
Energy saving (ECO)	For fixed use on battery power, the product performs measurements every 10 minutes over a programmable time range for a battery life of up to one year
Logger	Activation of programmed recording (P_REC) The start date, recording rate and end date can be customized with the PC software or the Android application. Possibility of locking the display in this mode (no values displayed). Manual activation (M_REC) Manual start and stop controls on the product. Recording is performed at the rate of the mode currently selected.
Specifications	
Recording rate	Customizable from 1 minute to 2 hours
Data storage	More than 1 million points
Buzzer and units	Yes / °C or °F
Backlighting / Hold / Min Max	Yes
Dimensions / weight	125 x 65.5 x 32 mm / 190 g with batteries
Power supply	Batteries: 2 x 1.5 V AA / LR6 or rechargeable battery Connection to mains possible with mains / micro USB adapter supplied as standard
Interfaces	2 communication modes possible: Bluetooth wireless communication and USB link; the product is then recognized as a USB key for easy file transfer
Mounting	CA 1510 casing equipped with a magnet, a wall-suspension system and a slit for hanging the product. A wall support for use with a padlock (padlock not supplied) is available as an accessory, as is a desktop stand (supplied as standard with the CA 1510W).
Processing software supplied as standard	Representation in graph or table format / Data export - Real-time mode / Report generation

STRENGTHS

- CO₂, temperature and humidity logger (up to 1 million points)
- Compact: for fixed or portable use
- User-friendly: thanks to the comfort-level indicators based on the level of CO₂ and hygrothermal criteria
- Accurate: complies with the latest regulations on air-quality monitoring
- Low gas consumption thanks to its in-situ calibration kit

ADDITIONAL INFO

- CA 1510 also available in black.... P01651010
- Delivered in a metal case

CONTENTS

Delivered in a neutral cardboard box:

- 2 x 1.5 V LR06 batteries
- 1 USB mains adapter
- 1 USB-micro USB cable
- 1 desk stand
- Software
- User's manual (5 languages) on CD-ROM
- 1 verification certificate



ACCESSORIES / REPLACEMENT PARTS

In-situ calibration kit	P01651022
Metal case	P01298071
See all the accessories on page 136	

CA 40

REF.: P01167501



LOW-FREQUENCY FIELDMETER

★ STRENGTHS

- Measurement of low-frequency magnetic fields
- Quick assessment of the radiation from equipment and installations
- Easy-to-handle unidirectional probe

⚙️ SPECIFICATIONS

	CA 40		
Magnetic field measurement	20 μ T	200 μ T	2000 μ T
Accuracy	$\pm(4\%+3\text{ cts})$	$\pm(5\%+3\text{ cts})$	$\pm(10\%+5\text{ cts})$
Frequency range	30 to 300 Hz		
Power density	-		
Output	-		
Probe	Unidirectional		
Alarm	-		
Data storage	-		
Dimensions	163 x 68 x 24 mm		
Weight	285 g		

⚙️ ACCESSORIES / REPLACEMENT PARTS

Soft case P01298036

📦 CONTENTS

- 1 probe
- 1 x 9 V 6LR61 battery

CA 7028

RJ 45

REF.: P01129501



LAN TESTER

★ STRENGTHS

- Graphical screen
- Detects, identifies and locates faults from up to 150 m away.
- Designed for use on UTP, STP, FTP, & SFTP cables equipped with RJ45 connectors and wired in compliance with the TIA 568A/B, USOC or ISDN specifications

⚙️ SPECIFICATIONS

	CA 7028
Connector	RJ 45
Types of cables	UTP, STP, FTP & SFTP
Faults indicated	Short-circuited pair, Wire in open circuit, Short-circuit between pairs, Crossed pairs, Reversed pairs, Shielding continuity
Remote modules	Identifiers nos. 1 to 9
Dimensions	165 x 90 x 37 mm
Weight	350 g

⚙️ ACCESSORIES / REPLACEMENT PARTS

Set of 4 identifiers nos. 2 to 5	P01101994
Set of 4 identifiers nos. 6 to 9	P01101995
See all the accessories on page 150	

📦 CONTENTS

- CA 7028 delivered with:
- 2 x RJ45 cables
 - 1 identifier no. 1
 - 1 soft case
 - 4 x 1.5 V LR06 batteries

DATAVIEW®

Data Logger
Transfer

REF.: PO1102095



ADDITIONAL INFO

- Totally configurable alarms and recordings on alarms
- The Dataview® software automatically recognizes the instrument connected when it is hooked up to the PC and launches the corresponding menu. Users then have direct access to its configuration and to the stored data.

FUNCTIONS

- Configuration of all the functions of instruments connected to a PC or via Bluetooth
- Display of the data in table and graph form
- Export to an Excel spreadsheet or jpeg image
- Programming of recordings (date and rate)
- Automatic export of reports in Word format

REQUIRED CONFIGURATION

- Windows Vista & Windows 7/8/10 (32/64 bit)
- 1 GB RAM for Windows Vista & Windows 7/8 (32 bit)
- 2 GB RAM for Windows Vista & Windows 7/8 (64 bit)
- 80 MB available space on hard disk (200 MB recommended)

DataView® modules	Data Logger Transfer
Related products	CA 1821
	CA 1822
	CA 1823
	CA 1246
	CA 1227
	CA 1110
	CA 1510
	CA 10001
	CA 10101
	CA 10141



Date	Time	Temperature	Relative Humidity	Due point
14/11/2016	17:44:06	23,32 °C	36,90 %	7,77 °C
14/11/2016	17:44:07	23,32 °C	36,90 %	7,77 °C
14/11/2016	17:44:08	23,32 °C	36,90 %	7,77 °C
14/11/2016	17:44:09	23,31 °C	36,88 %	7,75 °C
14/11/2016	17:44:10	23,31 °C	36,88 %	7,75 °C
14/11/2016	17:44:11	23,32 °C	36,88 %	7,76 °C
14/11/2016	17:44:12	23,31 °C	36,90 %	7,75 °C
14/11/2016	17:44:13	23,31 °C	36,90 %	7,75 °C
14/11/2016	17:44:14	23,31 °C	36,88 %	7,75 °C
14/11/2016	17:44:15	23,32 °C	36,90 %	7,77 °C
14/11/2016	17:44:16	23,31 °C	36,88 %	7,75 °C
14/11/2016	17:44:17	23,31 °C	36,90 %	7,76 °C
14/11/2016	17:44:18	23,31 °C	36,88 %	7,75 °C
14/11/2016	17:44:19	23,31 °C	36,88 %	7,75 °C
14/11/2016	17:44:20	23,31 °C	36,88 %	7,75 °C
14/11/2016	17:44:21	23,31 °C	36,88 %	7,75 °C
14/11/2016	17:44:22	23,31 °C	36,88 %	7,75 °C
14/11/2016	17:44:23	23,31 °C	36,88 %	7,75 °C
14/11/2016	17:44:24	23,31 °C	36,88 %	7,75 °C
14/11/2016	17:44:25	23,31 °C	36,88 %	7,75 °C
14/11/2016	17:44:26	23,31 °C	36,88 %	7,75 °C
14/11/2016	17:44:27	23,31 °C	36,88 %	7,75 °C
14/11/2016	17:44:28	23,31 °C	36,91 %	7,77 °C
14/11/2016	17:44:29	23,31 °C	36,91 %	7,77 °C
14/11/2016	17:44:30	23,31 °C	36,88 %	7,75 °C
14/11/2016	17:44:31	23,31 °C	36,91 %	7,77 °C
14/11/2016	17:44:32	23,31 °C	36,91 %	7,77 °C
14/11/2016	17:44:33	23,30 °C	36,91 %	7,76 °C

Session name: []

Session type

- Record now
- Schedule recording
- Alarm triggered recording

Start date: 16/11/2016 Start time: 11:22:00

End date: 16/11/2016 End time: 11:37:00

Storage duration: 000 : 00 : 15 : 00 (D : H : M : S) [Reset date/time]

Sampling period

Demand period: 1 s

Estimated battery autonomy

Not recording: Not
When recording: Not

The battery autonomy is only indicative. It takes into account the voltage level of batteries, which is dependent of temperature and battery quality. This indication assumes that your batteries were fully charged when replaced.

Disk space

10,23% of the memory has been used.
7,15 Mbytes of available memory, 7,96 Mbytes total memory capacity.

0,08% of the memory is needed by the current recording settings.
You should modify the settings of your recording or make space in the memory.

Keyboard locked during recording

Select this option to disable any keyboard action during recording. Once the recording starts with this option, keyboard is locked until the end of recording (end of session reached or with the "Stop recording" command of PhysICA Control Panel)

[Read] [Save] [Load]



ELECTROCHEMISTRY INFO AND ADVICE

pH

The term pH

The concept of pH was introduced in 1909 by S.P.L. Sørensen who described it as the measurement of the degree of acidity or alkalinity (basicity) of an aqueous solution. The pH is defined as the inverse of the decimal logarithm of the hydrogen ion concentration. $pH = -\log[H^+]$

A high concentration of H⁺ protons therefore indicates a very acidic pH and a low concentration of protons indicates a basic pH. The conventional pH range is from 0 to 14.

Potentiometric measurement of pH

The pH measurement involves two electrodes: the indicator electrode, which is pH-sensitive, and the reference electrode. To measure the pH of a solution, you must determine the difference in potential between these two electrodes. These electrodes are often grouped within a single enclosure to obtain a single electrode called a combination electrode.

The response of the indicator electrode depends on the concentration of H⁺ ions and it sends a signal proportional to the solution's degree of acidity/basicity. The reference electrode is not sensitive to the H⁺ ion concentration, so it delivers a constant potential which serves as a reference to measure the potential of the pH (or indicator) electrode.

The difference in potential generated is therefore proportional to the pH of the measurement medium (Nernst's equation).

CONDUCTIVITY

The concept of conductivity

Electrical conductivity is the capacity of a solution, a metal or a gas to allow an electric current to flow. The transmission of electricity through matter requires charged particles. In a solution, it is the anions and cations which carry the current, whereas in metal, it is the electrons. A solution's conductivity depends on 4 factors: concentration of the ions, mobility of the ions, valence of the ions and temperature.

Measurement principle of a conductivity meter

The measurement system is composed of a conductivity cell, a temperature sensor and a conductivity meter. The basic measurement principle is as follows: the conductivity cell comprises a pair of electrodes, known as poles, to which the instrument applies a voltage. The conductivity meter then measures the current flowing and calculates the conductivity value of the medium.

Measurement of TDS (Total Dissolved Solids) and salinity

Some conductivity meters can also be used to measure other parameters, such as TDS (Total Dissolved Solids) and salinity.

The TDS (Total Dissolved Solids) value is used to estimate the amount of solids dissolved in a solution. It corresponds to the mass of all the cations, anions and any other undissociated species present in an aqueous solution. It is expressed in mg/l or ppm.

Salinity measurement assesses salt levels, expressed in PSU (Practical Salinity Units).

pH-meters and conductivity meters are used in a wide range of sectors: agri-food, water analysis and treatment, industrial processes, environmental analysis, education, research, etc.



CA 10001 - CA 10002

REF.: PO1710015

REF.: PO1710016



IP 65 pH °C °F



★ STRENGTHS

- Watertight
- Simple measurement
- Long pH electrode
- Automatic calibration at 1, 2 or 3 points
- Automatic temperature compensation (ATC)

+ ADDITIONAL INFO

- CA 10001: general use, quick pH checks and isolated tests
- CA 10002: specially adapted for the agri-food sector with a pH electrode with a glass tip for measurements in semi-solid, protein-rich samples such as cheese, milk, etc

	CA 10001	CA 10002
Measurement ranges	pH 0.00 to 14.00 pH Temperature 0.0 to 60.0 °C / 32.0 to 140.0 °F	pH 2.00 to 12.00 pH Temperature 0.0 to 80.0 °C / 32.0 to 176.0 °F
Resolution	pH 0.01 pH Temperature 0.1 °C / 0.1 °F	pH 0.01 pH Temperature 0.5 °C / 0.5 °F
Error	pH ± 0.1 pH Temperature ± 1 °C / ± 2 °F	pH ± 0.1 pH Temperature ± 1 °C / ± 2 °F
Calibration	Automatic; 1, 2 or 3 points; buffers memorized	
Interchangeable electrode	No	
Power supply/ battery life	2 x CR2032 3V batteries / >100 hours	
Automatic power off	After 20 minutes without use	
Dimensions/weight	226 x 36 x 20 mm / 65 g	228 x 36 x 20 mm / 65 g
Environment	0 to 50 °C (32 to 122 °F); max. HR 80 %	0 to 80 °C (32 to 176 °F); max. HR 80 %
Warranty	1 year	

📦 CONTENTS

Instrument delivered in a cardboard box with:

- 2 x CR2032 3V batteries,
- 1 storage vial for the electrode,
- 1 multilingual user's manual,
- 1 verification certificate.

🧰 ACCESSORIES / REPLACEMENT PARTS

pH 4.01 buffer solution (DIN-NIST)*, 125 mL	PO1700106
pH 7.00 buffer solution (DIN-NIST)*, 125 mL	PO1700107
pH 10.01 buffer solution (DIN-NIST)*, 125 mL	PO1700109
Set of 3 plastic beakers	PO1710056

* Solution delivered with a quality certificate guaranteeing compliance with the NIST (National Institute of Standards and Technology) and DIN 19266 standards.

CA 10101

REF.: P01710010

IP 67 pH Redox °C °F

Diagnostics & inspection
Education
Energy efficiency
Transport
Tertiary & residential
Industries
Generation, transmission & distribution
Laboratory & metrology



STRENGTHS

- Ergonomic, rugged and 100% watertight
- Extra-wide multi-display LCD screen
- Guided, ultra-simplified pH calibration (up to 3 buffer solutions)
- Immediate or programmable recordings of more than 100,000 time/date-stamped measurements
- Signal stability indicator

ADDITIONAL INFO

- Shockproof sheath supplied as standard
- µUSB port for data transfer onto PC
- Compatible with the Data Logger Transfer module of the Dataview® software for:
 - configuration of the instrument
 - display of the data
 - recovery of the recorded measurements (samples and calibrations)
 - programming of recordings
 - automatic export of the reports

ACCESSORIES / REPLACEMENT PARTS

XRGST1 pH combination electrode with built-in temperature sensor	P01710051
XRPTST1 ORP combination electrode with built-in temperature sensor	P01710052

See all the accessories on page 136

SPECIFICATIONS

Measurement parameters	CA 10101	
pH	-2.00 to 16.00 pH	
Measurement ranges (instrument alone)	Redox	±199.9 mV -1999 to -200 and +200 to +1999 mV
	Temperature	-10.0 to +120.0°C / 14.0 to 248.0°F
	Resolution (R)	pH: 0.01 pH Redox: 0.1 mV 1 mV Temperature: 0.1 °C / 0.1 °F
Intrinsic uncertainty of the instrument (without electrode)	pH	± 0.01 pH ± R
	Redox	± 0.1 mV ± R ± 1 mV ± R
	Temperature	< 0.4°C / < 0.7°F
Calibration	pH	Automatic, up to 3 points, 3 groups of predefined standard reference solutions (modifiable)
	Redox	Automatic, 1 point, two predefined standard reference solution values (modifiable)
Temperature compensation	Automatic (ATC) or manual (MTC), -10°C to +120°C (14°F to 248°F)	
Electrode	pH	XRGST1 (supplied), pH combination electrode with built-in temperature sensor (Pt1000), 8-pin DIN connector and 1 m cable
	Redox	XRPTST1 (option), ORP combination electrode with built-in temperature sensor (Pt1000), 8-pin DIN connector and 1 m cable
Data storage	Date and time	Yes
	Storage	> 100,000 measurements
Connectors	Sensor input	8-pin DIN (adapters for BNC, S7 and Jack available as options)
	Communication interface	Type-B micro USB (USB device)
Batteries	Number - Type	4 x 1.5 V AA or LR06 alkaline batteries
	Battery life	Approximately 300 hours of continuous operation
	Auto power-off	Automatic power-off after 3, 10 or 15 min without use (adjustable)
Ingress protection	IP67	
Environmental conditions	Storage range (excluding batteries, electrodes & buffer solutions)	-20 to + 70°C
	Operating range	-10 to +55 °C
Dimensions (with sheath)	211 x 127 x 54 mm	
Weight (without electrode)	600 g	
Warranty (instrument alone)	2 years	

CONTENTS

CA 10101 delivered in site-proof case with:

- 1 x XRGST1 pH electrode with built-in temperature sensor
- 4 x 1.5 V LR06 batteries
- 1 protective sheath mounted on the instrument
- 2 ready-to-use pH 4.01 and 7.00 buffer solutions (compliant with NIST/DIN)
- 2 plastic beakers
- 1 USB/µUSB cable
- 1 wrist strap



CA 10141

REF.: P01710020

IP 67
Conductivity
TDS
Resistivity
Salinity
°C
°F

Diagnostics & inspection
Education
Energy efficiency
Transport
Tertiary & residential
Industries
Generation, transmission & distribution
Laboratory & metrology



★ STRENGTHS

- Parameters measured: conductivity, TDS (Total Dissolved Solids), resistivity, salinity, temperature (°C or °F)
- Ergonomic, rugged and watertight
- Extra-wide multi-display LCD screen
- Storage of 100,000 time/date-stamped measurements
- Signal stability indicator
- Calibration: 1 point, 6 predefined conductivity reference standards (user-modifiable)

+ ADDITIONAL INFO

Simultaneous display of the conductivity specific to the selected reference temperature (20 or 25 °C) and the actual temperature of the sample

- USB interface for easy data export onto PC
- Compatible with the Data Logger Transfer module of the Dataview software
- Adjustable reference temperature, temperature correction coefficient and TDS factor

⚙️ ACCESSORIES / REPLACEMENT PARTS

147 µS/cm conductivity standard reference solution	P01700117
1408 µS/cm conductivity standard reference solution	P01700118

See all the accessories on page 136

⚙️ SPECIFICATIONS

	CA 10141
Conductivity	
Measurement ranges (instrument alone)	0.050 S/cm to 500.0 mS/cm
Resolution (R)	0.001 to 0.1 (depending on range)
Intrinsic uncertainty (instrument alone)	± 0.5% ± R
TDS	
Measurement ranges (instrument alone)	0.001 mg/l to 499.9 g/l
Resolution (R)	0.001 to 0.1 (depending on range)
Intrinsic uncertainty (instrument alone)	± 0.5% ± R
Resistivity	
Measurement ranges (instrument alone)	2.000 Ω.cm to 19.99 MΩ.cm
Resolution (R)	0.001 to 0.01 (depending on range)
Intrinsic uncertainty (instrument alone)	± 0.5% ± R
Salinity	
Measurement ranges (instrument alone)	2.0 to 42.0 psu
Resolution (R)	0.1
Intrinsic uncertainty (instrument alone)	± 0.5% ± R
Temperature	
Measurement ranges (instrument alone)	- 10 to + 120°C (14 to 248°F)
Resolution (R)	0.1 °C (0.1°F)
Intrinsic uncertainty (instrument alone)	< 0.4°C (< 0.7°F)
Available reference temperature	20/25 °C (68/77°F)
Calibration	1 point, 6 predefined conductivity reference standards (user-modifiable); Possibility of returning to a default calibration
Temperature compensation	
Temperature compensation mode	Automatic (ATC) or manual (MTC), linear or non-linear
Conductivity sensor	
Type	XCP4ST1 (supplied), 4-pole conductivity sensor with built-in temperature sensor (Pt 1000)
Connector	8-pin DIN, 1 m cable
Data storage	
Date and time	Yes
Storage	> 100,000 measurements
Sensor input	8-pin DIN (adapters for BNC, S7 & Jack available as options)
Communication interface	Type B micro-USB (USB device) 12 Mbit/s
Batteries	
Number - Type	4 x 1.5 V AA or LR06 alkaline batteries
Battery life	Approx. 300 hours of continuous operation
Auto power-off	After 3, 10 or 15 min without use (adjustable)
Environmental conditions	
Storage range (without batteries)	-20 to 70 °C
Operating range	-10 to +55 °C
Ingress protection	IP67
Dimensions (with sheath)	211 x 127 x 54 mm
Weight (without sensor)	600 g
Warranty (instrument alone)	2 years

📦 CONTENTS

CA 10141 delivered in site-proof case with:

- 1 x XCP4ST1 4-pole conductivity cell with built-in temperature sensor
- 4 x 1.5 V LR06 batteries
- 1 protective sheath mounted on the instrument
- 1 x 1408 µS/cm conductivity standard reference solution
- 1 plastic beaker
- 1 USB - micro USB cable
- 1 wrist strap



THERMOMETERS

K THERMOCOUPLE SENSORS

Model	Model	Description	Type / Application	Measurement range	Tolerance class	Response time at 63%	Plunger diameter	Plunger length	Ref.	Model
	 SK20	Sheathed sensor as per the NF EN 61615 standard. Hot junction isolated from chassis-earth. Inconel 600 protective sheath	Flexible general-purpose sensor	-40 °C to 450 °C	Cl. 1	1 s	1,5 mm	1 m	P01655010	SK20
	 SK6	"General-purpose" sensor recommended for measurements where access is difficult. Do not use in liquids (tip is not watertight)	Flexible sensor	-50 °C to 285 °C	Cl. 2	1 s by contact	1 mm	1 m	P03652906	SK6
	 SK2	Sensor with stainless-steel sheath which can be bent as required. Radius of curvature > 4 mm	Bendable general-purpose sensor	-50 °C to 1000 °C	Cl. 2	3 s in ambient conditions	2 mm	1 m	P03652902	SK2
	 SK3	Slightly bendable sensor with stainless-steel sheath	Semi-rigid general-purpose sensor	-50 °C to 1000 °C	Cl. 2	2 s	4 mm	50 cm	P03652903	SK3
	 SK13	Sensor with stainless-steel sheath	General-purpose sensor	-50 °C to 1100 °C	Cl. 2	6 s	3 mm	30 cm	P03652918	SK13
	 SK7	In "calm" conditions without air movement, shake the sensor to encourage heat exchange	Air sensor for ambient measurement	-50 °C to 250 °C	Cl. 2	12 s	5 mm	15 cm	P03652907	SK7
	 SK17	In "calm" conditions without air movement, shake the sensor to encourage heat exchange	Air sensor for ambient measurement	-50 °C to 600 °C	Cl. 2	5 s	6 mm	13 cm	P03652921	SK17
	 SK1	Sensor with stainless-steel sheath for penetration (20 mm min.) in pasty, viscous or liquid specimens	Needle sensor for penetration	-50 °C to 800 °C	Cl. 2	1 s	3 mm	15 cm	P03652901	SK1
	 SK11	Sensor with stainless-steel sheath for penetration (20 mm min.) in pasty, viscous or liquid specimens	Needle sensor for penetration	50 °C to 600 °C	Cl. 2	12 s	3 mm	13 cm	P03652917	SK11
	 SK4	Sheathed sensor with stainless-steel sensing element and Teflon base. For small flat surfaces. Contact can be improved by using silicone grease.	Surface sensor	0°C à 250°C	Cl. 2	1 s	5 mm	15 cm	P03652904	SK4
	 SK14	For surface temperatures when access is difficult	Elbowed surface sensor	-50°C to 450°C	Cl. 2	8 s	6 mm	13 cm	P03652919	SK14
	 SK5	For flat surfaces. The spring ensures optimum contact even if the sensor is not positioned perpendicularly. Contact can be improved by using silicone grease.	Surface sensor with spring	-50°C to 500°C	Cl. 2	1 s	5 mm Ø in contact 8.5 mm	15 cm	P03652905	SK5
	 SK15	For flat surfaces. The spring ensures optimum contact even if the sensor is not positioned perpendicularly. Contact can be improved by using silicone grease.	Surface sensor with spring	-50°C to 900°C	Cl. 2	2 s	8 mm	13 cm	P03652920	SK15
	 SK8	For measurements on pipes. The copper sheet is applied to the clean, dry pipe. The two-sided Velcro strip ensures contact by winding.	Pipe sensor	-50°C to 140°C	Cl. 2	10 seconds on stainless-steel pipe with 12 mm diameter	Ø 10-90 mm	32 cm	P03652908	SK8
	 SK19	Sensor with magnet for flat metal surfaces	Magnetic sensor	-50°C to 200°C	Cl. 2	7 s	4 mm	1 m	P03652922	SK19

Accuracy Class I / -40 °C to +375 °C: ± 1.5°C / +375 °C to +1000°C: ± 0.004 x T °C.
Accuracy Class II / -40 °C to +333 °C: ± 2.5°C / +333 °C to +1200°C: ± 0.0075 x T °C.

Standard compensated miniature male 2-pole connector.
Spiral cable from 45 cm to 1m

ACCESSORIES / REPLACEMENT PARTS

EXTENSIONS FOR THERMOCOUPLES

	CK 1	CK 2	CK 3	CK 4
Models	Description		∅	Length
CK 1	Terminated by male plug / female plug		4 mm	1 m
CK 2	Terminated by male plug / 2 bare wires		4 mm	1 m
CK 3	Terminated by 5-pin DIN plug / female socket		4 mm	1 m
CK 4	Terminated by 2 banana plugs / female socket		4 mm	1 m
Temperature withstand of extensions: -40 °C to +100 °C				



CK 3 CK 2 CK 1 CK 4

REFERENCES TO ORDER

- CK 1 P03652909
- CK 2 P03652910
- CK 3..... P03652913
- CK 4..... P03652914





ACCESSORIES / REPLACEMENT PARTS

- PP1 handle for CK extensions P03652912
- Compensated miniature male 2-pole connector P03652925



PT 100 Ω TEMPERATURE SENSORS

- Pt 100 Ω temperature sensors

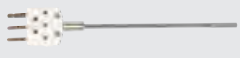
Model	Model	Type / Application	Description	Measurement range	Tolerance class	Response time at 63%	Plunger diameter	Plunger length	Ref.
	SP 10	Surface sensor with spring	For flat surfaces The spring ensures optimum contact, even if the sensor is not set up perpendicularly. Silicone grease can be used to improve contact.	-50 °C to 200 °C	Cl. B	6 s	5 mm	13 cm	P03652712
	SP 11	Needles sensor for penetration	For penetration (20 mm minimum) in pasty, viscous or liquid media.	-100 °C to 600 °C	Cl. B	7 s	3 mm	13 cm	P03652713
	SP 12	Air sensor	In "calm" conditions without air movement, shake the sensor to encourage heat exchange	-100 °C to 600 °C	Cl. B	5 s	5 mm	13 cm	P03652714
	SP 13	Sensor for immersion	Sensor with stainless-steel sheath specially designed for liquids	-100 °C to 600 °C	Cl. B	7 s	3 mm	13 cm	P03652715
	SP 14	General-purpose sensor	316L stainless-steel sensor for general use	-100 °C to 450 °C	Cl. A	7 s	3 mm	20 cm	P01655020

Accuracy Class A / 0.15 °C + 0.002 x T °C

Accuracy Class B / 0.3 °C + 0.005 x T °C

Miniature 3-pole flat-pin connector

Spiral cable from 45 cm to 1m

ACCESSORIES / REPLACEMENT PARTS

CALIBRATORS

CA 1621, CA 1623 and CA 1631

- Mains power supply P01103057
- Bag-MF 120 x 245 x 60 mm P01298075
- Set of 2 red/black crocodile clips P01295457Z
- Set of 2 red/black moulded PVC cables P01295451Z
- Set of 2 x Ø 4 mm moulded test probes P01295458Z

PH-METER

CA 10101

- pH 1.68 NIST* buffer solution, 125 ml P01700105
 - pH 4.01 NIST* buffer solution, 125 ml P01700106
 - pH 7.00 NIST* buffer solution, 125 ml P01700107
 - pH 9.18 NIST* buffer solution, 125 ml P01700108
 - pH 10.01 NIST* buffer solution, 125 ml P01700109
 - 220 mV ORP buffer solution, 125 ml P01700114
 - 468 mV ORP buffer solution, 125 ml P01700115
 - XRPTST1 ORP combination electrode with built-in temperature sensor P01710052
 - XRGST1 pH combination electrode with built-in temperature sensor P01710051
 - Set of 3 plastic beakers P01710056
 - Shockproof sheath P01710050
 - Adapter: 8-pin DIN to BNC & Jack** P01295501
 - Adapter: 8-pin DIN to S7 & Jack** P01295502
- *Solution delivered with a quality certificate guaranteeing compliance with the NIST (National Institute of Standards and Technology) and DIN 19266 standards
- **Connection adapters for Chauvin Arnoux pH/redox and temperature sensors

CONDUCTIVITY METER

CA 10141

- XCP4ST1 conductivity cell with built-in temperature sensor P01710053
- Conductivity standard reference solution 147 µS/cm P01700117
- Conductivity standard reference solution 1408 µS/cm P01700118
- Conductivity standard reference solution 12.85 mS/cm P01700119
- Concentrated standard KCl solution 1mol/l P01700116
- Set of 3 plastic beakers P01710056
- Conductivity adapter: 8-pin DIN to BNC & Jack P01710054
- Conductivity adapter: 8-pin DIN to S7 & Jack P01710055
- Shockproof sheath P01710050

THERMOMETERS

CA 1821, CA 1822 and CA 1823

- Shockproof sheath + Multifix P01654252
- Multifix P01102100Z
- Mains adapter P01651023
- Carrying bag P01298075
- Metal case P01298071
- Dataview® software P01102095
- Bluetooth BLE modem / USB for PC P01654253
- Set of 4 x 1.5 V AA/LR6 rechargeable batteries + charger HX0053

THERMO-HYGROMETER

CA 1246

- 75%RH salt cartridge P01156401
- 33%RH salt cartridge P01156402
- Shockproof sheath + Multifix P01654252
- Multifix P01102100Z
- Mains adapter P01651023
- Carrying bag P01298075
- Metal case P01298071
- Dataview® software P01102095
- Bluetooth BLE modem / USB for PC P01654253

- set of 4 x 1.5 V AA/LR6 rechargeable batteries + charger HX0053

THERMO-ANEMOMETER

CA 1227

- Cones kit for vane flow-rate measurement (circular cross-section Ø 210mm and rectangular cross-section 346x346mm) P01654250
- Vane sensor Ø80mm P01654251
- Shockproof sheath + Multifix P01654252
- Multifix P01102100Z
- Mains adapter P01651023
- Carrying bag P01298075
- Metal case P01298071
- Dataview® software P01102095
- Modem Bluetooth BLE / USB pour PC P01654253
- Set of 4 x 1.5 V AA/LR6 rechargeable batteries + charger HX0053

LUXMETERS

CA 1110

- Shockproof sheath + Multifix P01654252
- Multifix P01102100Z
- Mains adapter P01651023
- Carrying bag P01298075
- Metal case P01298071
- Dataview® software P01102095
- Bluetooth BLE modem / USB for PC P01654253
- Set of 4 x 1.5 V AA/LR6 rechargeable batteries + charger HX0053

SOUND LEVEL METERS

CA 832 and CA 1310

- CA 833 sound level meter calibrator, 94 dB or 114 dB P01185301
- Microphone extension for CA 834 (5 metres) P01102085
- Foam wind shield P01102083
- Jack/USB cable for CA 834 P01295478

TACHOMETERS

CA 1725 and CA 1727

- Mechanical accessories kit P01174902
- End-fittings (set of 3) P01174903
- Reflective tape (15 strips 0.1 m long) P01101797
- FRB F socket P01101785
- TACHOGRAPH software on CD-ROM P01174835
- USB-A to USB-B cable P01295293

CO2 - TEMPERATURE - HUMIDITY LOGGER

CA 1510

- In-situ calibration kit P01651022
- Hard case P01298071
- Desk stand P01651021
- Wall support P01651020
- USB mains adapter P01651023
- USB-Bluetooth adapter P01102112
- Set of 4 x 1.5 V AA/LR6 rechargeable batteries + charger HX0053

CO DETECTOR

CA 895

- Aspiration kit with pump and extension P01651101



For the CA 1246

- 75% RH salt cartridge P01156401



For the CA 1227 -

CA 1110 - CA 1821/22/23 - CA 1246

- Shockproof sheath + Multifix P01654252



For the CA 1227 - CA 1110 - CA 1821/22/23 -

CA 1246 - CA 1510

- Mains adapter P01651023



For the CA 1227

- Cones kit for vane flow-rate measurement P01654250



For the CA 832 - CA 1310

- Sound level meter calibrator P01185301



For the CA 1725 - CA 1727

- Mechanical accessories kit P01174902



For the CA 1510

- In-situ calibration kit P01651022



For the CA 1510

- Desk stand P01651021



For the CA 1510

- Wall-mount P01651020

See all our accessories
on page 150

CURRENT MEASUREMENT

AC CURRENT CLAMPS	139
AC/DC CURRENT CLAMPS	141
FLEXIBLE CURRENT SENSORS	142
ACCESSORIES / REPLACEMENT PARTS	143

CHOOSING YOUR CURRENT CLAMP

There is a wide range of criteria for choosing a current clamp. The approach below is designed to help define your requirements and guide you naturally towards the model which best suits your application. The criteria selected are classified from 1 to 6.

To choose your clamp, we advise you to follow this logic:

- Measurement of direct or alternating current?
 - > AC/DC clamps table or AC clamps table
- High or low currents?
 - > see the "Input" column to define the appropriate families of clamps
- On small wires or large cables?
 - > see the diagrams at the bottom of the next page and only choose families with the shapes and dimensions required

- What instrument will it be connected to?
 - > see "Output / Connection" column to choose to clamp with compatible signal and connection possibilities
- What are your other criteria?
 - > see "Specific features" column to check that the clamp chosen fulfils your requirements perfectly

THE WIDEST RANGE OF IEC 61010-2-032 CLAMPS

Our innovation, technical expertise and determination to manufacture top-quality products that comply with standards have made Chauvin Arnoux the worldwide specialist in current clamps.

On the next few pages, you will find a table presenting the clamps for measuring AC/DC current, followed by a diagram giving the clamp form with dimensions and

then another table grouping a large number of models for AC current.

As a result of their specifications, certain clamps are specialized for specific applications:

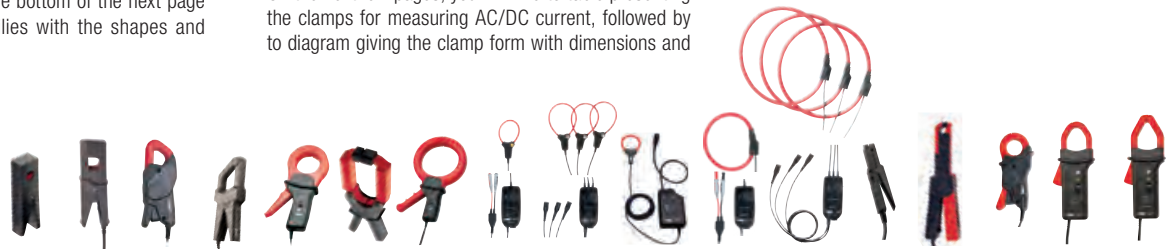

- Clamps for oscilloscopes (BNC output): E27, PAC17, PAC27, MN60, Y7N, C160, D38N and MA200
- Clamps for leakage currents: MN73, C173 and B102
- Clamps for process currents: K1 and K2
- Clamp for measurements on the secondary windings of current transformers: MN71



	MINI 0X page 139	MINI 10x* page 139	MN page 139	YN page 139	C1xx page 140	DN page 140	Bxx page 140	MiniFlex® MA110 Series page 142	MiniFlex® MA130 Series page 142	MiniFlex® MA200 Series page 142	AmpFlex® A110 Series page 142	AmpFlex® A130 Series page 142	K page 141	E2X page 141	MH60 page 141	PAC 1x page 141	PAC 2x page 141	
For currents																		
Clamping Ø (mm)	10	16	20	30	52	64	115	45 70 100	70	45 70 100	140 250 380	250	3,9	8	26	30	39	
AC	■	■	■	■	■	■	■	■	■	■	■	■	■	■	■	■	■	
DC																		
Min	5 mA	5 mA	10 mA	1 A	1 mA	100 mA	500 µA	80 mA	500 mA	500 mA	80 mA	500 mA	100 µA	5 mA	1 mA	500 mA	500 mA	
MAX	150 A	200 A	240 A	600 A	1200 A	3600 A	400 A	3000 A	3000 A	3000 A	30000 A	3000 A	4,5 A	150 A	140 A	600 A	1400 A	
Output																		
in mA _{AC}	■	■	■	■	■	■	■	■	■	■	■	■						
in mV _{AC}	■	■	■	■	■	■	■	■	■	■	■	■						
in mV _{OC}	■		■	■														
in mV _{AC+DC}													■	■	■	■	■	
Connection																		
Insulated Ø 4 mm sockets			■		■	■												
Cable with Ø 4 mm insulated elbow male plugs	■	■	■	■	■	■	■	■			■			■		■	■	
Insulated Ø 4 mm plug box with standard 19 mm spacing													■					
Coaxial cable with insulated male BNC connector			■	■	■	■			■	■		■		■	■	■	■	
Single-calibre	■	■	■	■	■	■	■	■	■	■	■	■	■	■	■	■	■	
Multi-calibre	■	■	■	■	■	■	■	■	■	■	■	■	■	■	■	■	■	
For multimeters	■		■	■	■	■	■	■	■	■	■	■	■	■	■	■	■	
For oscilloscopes			■	■	■	■	■	■	■	■	■	■		■	■	■	■	
For detecting leakage and insulation faults			■		■		■											
For measuring power, harmonics, etc.	■	■	■		■	■		■	■	■	■	■		■		■	■	
For the process and the 4-20/0-20 mA measurement loop													■					
Power supply																		
Stand-alone	■	■	■	■	■	■	■	■	■	■	■	■	■	■	■	■	■	
Batteries(s)								■	■	■	■	■	■	■	■	■	■	
Mains adapter								■	■	■	■	■	■	■	■	■	■	

* for multimeters

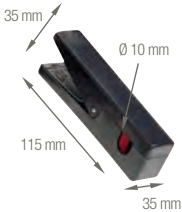
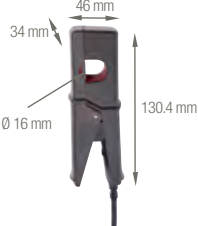
AC CURRENT MEASUREMENT

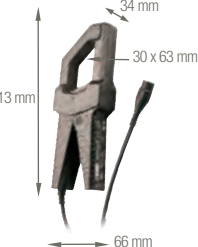
Series	Model	Input					Output - Connection			Specific Features					Reference				
		Very low current	Low current	Medium current	High current	Alternating current	Direct current	Current	Voltage	Cable + \varnothing 4 mm safety plugs	Female \varnothing 4 mm sockets	BNC connector (coaxial)	Transformation ratio (input/output)	Output protected against overvoltages		Automatic DC zero	Power measurement (low phase shift)	Bandwidth (frequency in Hz)	Typical accuracy
	MINI 01		2 to 150 A				0.15 A _{AC}					1000/1				48 Hz...500 Hz	$\leq 2.5\%$	P01105101Z	
	MINI 02	50 mA to 100 A					0.15 A _{AC}					1000/1				48 Hz...10 kHz	$\leq 1\%$	P01105102Z	
	MINI 03		1 to 100 A					0.1 V _{AC}				1 A / 1 mV					$\leq 2\%$	P01105103Z	
	MINI 05	5 mA to 10 A 1 to 100 A						10 V _{AC} 0.1 V _{AC}				1 mA / 1 mV 1 A / 1 mV				48 Hz...500 Hz	$\leq 3\%$ $\leq 2\%$	P01105105Z	
	MINI 09		1 to 150 A					15 V _{DC} (2)				1 A / 100 mV					$\leq 4\%$	P01105109Z	
	MINI102		0.05 A to 200 A				0.2 A _{AC}					1000/1				48 Hz...10 kHz	$\leq 1\%$	P01106102	
	MINI103		0.1 A to 200 A					0.2 V _{AC}				1 A / 1 mV				48 Hz...10 kHz	$\leq 1.5\%$	P01106103	
	MN08		0.5 to 240 A				0.2 A _{AC}					1000/1				40 Hz...10 kHz	$\leq 1\%$	P01120401	
	MN09		0.5 to 240 A				0.2 A _{AC}					1000/1					$\leq 1\%$	P01120402	
	MN10		0.5 to 240 A				0.2 A _{AC}					1000/1					$\leq 2\%$	P01120403	
	MN11		0.5 to 240 A				0.2 A _{AC}					1000/1					$\leq 2\%$	P01120404	
	MN12		0.5 to 240 A					2 V _{AC}				1 A / 10 mV					$\leq 1\%$	P01120405	
	MN13		0.5 to 240 A					2 V _{AC}				1 A / 10 mV					$\leq 1\%$	P01120406	
	MN14		0.5 to 240 A					0.2 V _{AC}				1 A / 1 mV					$\leq 1\%$	P01120416	
	MN15		0.5 to 240 A					0.2 V _{AC}				1 A / 1 mV					$\leq 1\%$	P01120417	
	MN21		0.1 to 240 A				0.2 A _{AC}					1000/1					$\leq 2\%$	P01120418	
	MN23		0.1 to 240 A					2 V _{AC}				1 A / 10 mV					$\leq 1.5\%$	P01120419	
	MN38		0.1 to 24 A 0.5 to 240 A					2 V _{AC} 2 V _{AC}				1 A / 100 mV 1 A / 10 mV					$\leq 1\%$	P01120407	
	MN39		0.1 to 24 A 0.5 to 240 A					2 V _{AC} 2 V _{AC}				1 A / 100 mV 1 A / 10 mV					$\leq 1\%$	P01120408	
	MN60		0.1 A to 60 A _{PEAK} 0.5 A to 600 A _{PEAK}					6 V _{PEAK} 6 V _{PEAK}				1 A / 100 mV 1 A / 10 mV					40 Hz...40 kHz	$\leq 2\%$ $\leq 1.5\%$	P01120409
	MN71		10 mA to 12 A					1 V _{AC}				1 A / 100 mV					$\leq 1\%$	P01120420	
	MN73		10 mA to 2.4 A 100 mA to 240 A					2 V _{AC} 2 V _{AC}				1 mA / 1 mV 1 A / 10 mV					40 Hz...10 kHz	$\leq 1\%$ $\leq 2\%$	P01120421
MN88		0.5 to 240 A					20 V _{DC} (2)				1 A / 100 mV				$\leq 2\%$	P01120410			
MN89		0.5 to 240 A					20 V _{DC} (2)				1 A / 100 mV				$\leq 2\%$	P01120415			
	Y1N		4 A to 500 A				0.5 A _{AC}					1000/1				48 Hz...1 kHz	$\leq 3\%$	P01120001A	
	Y2N		4 A to 500 A				0.5 A _{AC}					1000/1					$\leq 1\%$	P01120028A	
	Y3N		4 A to 500 A				5 A _{AC}					100/1					$\leq 3\%$	P01120029A	
	Y4N		4 A to 500 A					0.5 V _{DC} (2)				500 A / 0.5 V					$\leq 1\%$	P01120005A	
	Y7N		1 A to 1200 A _{PEAK}					1.2 V _{peak}				1 A / 1 mV					5 Hz...10 kHz	$\leq 2\%$	P01120075

(1) The upper value corresponds to 120 % of the max. rated value.. (2) Reshaping of AC signal by diodes



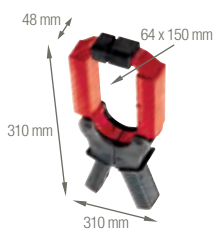

AC CURRENT MEASUREMENT

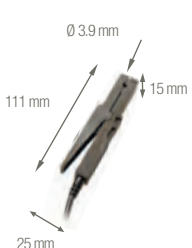

Series	Model	Input					Output - Connection					Specific Features					Reference	
		Very low current	Low current	Medium current	High current	Alternating current	Direct current	Current	Voltage	Cable + ø 4 mm safety plugs	Female ø 4 mm sockets	BNC connector (coaxial)	Transformation ratio (Input/Output)	Output protected against overvoltages	Automatic DC zero	Power measurement (low phase shift)		Bandwidth (frequency in Hz)
	C100	0.1 A to 1200 A					1 AAC					1000/1				30 Hz...10 kHz	≤ 0.5 %	P01120301
	C102	0.1 A to 1200 A					1 AAC					1000/1					≤ 0.5 %	P01120302
	C103	0.1 A to 1200 A					1 AAC					1000/1					≤ 0.5 %	P01120303
	C106	0.1 A to 1200 A						1 VAC				1 A / 1 mV					≤ 0.5 %	P01120304
	C107	0.1 A to 1200 A						1 VAC				1 A / 1 mV					≤ 0.5 %	P01120305
	C112	1 mA to 1200 A					1 AAC					1000/1					≤ 0.3 %	P01120314
	C113	1 mA to 1200 A					1 AAC					1000/1					≤ 0.3 %	P01120315
	C116	1 mA to 1200 A						1 VAC				1 A / 1 mV					≤ 0.3 %	P01120316
	C117	1 mA to 1200 A						1 VAC				1 A / 1 mV					≤ 0.3 %	P01120317
	C122	1 A to 1200 A					5 AAC					1000/5					≤ 1 %	P01120306
	C148	1 A to 300 A 1 A to 600 A 1 A to 1200 A					5 AAC					250/5 500/5 1000/5			48 Hz...1 kHz	≤ 2 % ≤ 1 % ≤ 1 %	P01120307	
	C160	0.1 A to 30 A _{PEAK} 0.1 A to 300 A _{PEAK} 1 A to 2000 A _{PEAK}						3 V _{PEAK} 3 V _{PEAK} 2 V _{PEAK}				10 A / 1 V 100 A / 1 V 1000 A / 1 V			10 Hz...100 kHz	≤ 3 % ≤ 2 % ≤ 1 %	P01120308	
	C173	1 mA to 1.2 A 0.01 A to 12 A 0.1 A to 120 A 1 A to 1200 A						1 VAC				1 A / 1 V 10 A / 1 V 100 A / 1 V 1000 A / 1 V			10 Hz...3 kHz	≤ 0.7 % ≤ 0.5 % ≤ 0.3 % ≤ 0.2 %	P01120309	
	B102	500 µA to 4 A 0.5 A to 400 A						4 VAC 0.4 VAC				1 mA / 1 mV 1 A / 1 mV			10 Hz...1 kHz	≤ 0.5 % ≤ 0.35 %	P01120083	
	D30N			1 A to 3600 A			1 AAC					3000/1			30 Hz...5 kHz	≤ 0.5 %	P01120049A	
	D30CN			1 A to 3600 A			1 AAC					3000/1				≤ 0.5 %	P01120064	
	D31N			1 A to 600 A 1 A to 1200 A 1 A to 1800 A			1 AAC					500/1 1000/1 1500/1			30 Hz...1.5 kHz	≤ 3 % ≤ 1 % ≤ 0.5 %	P01120050A	
	D32N			1 A to 1200 A 1 A to 2400 A 1 A to 3600 A			1 AAC					1000/1 2000/1 3000/1			30 Hz...1 kHz	≤ 1 % ≤ 0.5 % ≤ 0.5 %	P01120051A	
	D33N			1 A to 3600 A			5 AAC					3000/5			30 Hz...5 kHz	≤ 1 %	P01120052A	
	D34N			1 A to 600 A 1 A to 1200 A 1 A to 1800 A			5 AAC					500/5 1000/5 1500/5			30 Hz...1.5 kHz	≤ 3 % ≤ 1 % ≤ 0.5 %	P01120053A	
	D35N			1 A to 1200 A 1 A to 2400 A 1 A to 3600 A			5 AAC					1000/5 2000/5 3000/5				≤ 1 % ≤ 0.5 % ≤ 0.5 %	P01120054A	
	D36N			1 A to 3600 A			3 AAC					3000/3			30 Hz...5 kHz	≤ 0.5 %	P01120055A	
	D37N			0.1 A to 36 A 1 A to 360 A 1 A to 3600 A				3 VAC				30 A/3 V 300 A/3 V 3000 A/3 V			30 Hz...5 kHz	≤ 2 %	P01120056A	
	D38N			1 A to 90 A _{PEAK} 1 A to 900 A _{PEAK} 1 A to 9000 A _{PEAK}				0.9 V _{PEAK}				1 A / 10 mV 1 A / 1 mV 1 A / 0.1 mV			30 Hz...50 kHz	≤ 2 %	P01120057A	

(1) The upper value corresponds to 120 % of the max. rated value.. (2) Reshaping of AC signal by diodes

AC/DC CURRENT MEASUREMENT

Series	Model	Input					Output - Connection			Specific Features					Reference
		Measurement range					Current	Voltage	Cable + Ø 4 mm safety plugs Female Ø 4 mm sockets BNC connector (coaxial)	Transformation ratio (Input/Output)	Output protected against overvoltages Automatic DC zero	Power measurement (low phase shift)	Bandwidth (frequency in Hz)	Typical accuracy	
Very low current	Low current	Medium current	High current	Alternating current	Direct current										
 <p>Ø 3.9 mm 111 mm 15 mm 25 mm</p>	K1	1 mA to 4.5 A _{DC} 1 mA to 3 A RMS 1 mA to 4.5 A _{PEAK}					4.5 V _{AC} 3 V _{RMS} 4.5 V _{PEAK}	(2)		1 mA / 1 mV			DC to 2 kHz	≤ 1 %	P01120067A
	K2	100 µA to 450 mA _{DC} 100 µA to 300 mA _{RMS} 100 µA to 450 mA _{PEAK}					4.5 V _{AC} 3 V _{RMS} 4.5 V _{PEAK}	(2)		1 mA / 10 mV			DC to 1.5 kHz	≤ 1 %	P01120074A
 <p>67 mm 231 mm Ø 11.8 mm 20 mm</p>	E25	5 mA to 2 A _{DC} 5 mA to 1.5 A _{AC} 50 mA to 80 A _{DC} 50 mA to 60 A _{AC}				2 V _{DC} 1.5 V _{AC} 600 mV _{DC} 800 mV _{DC}			1 A / 1 V 1 A / 10 mV			DC to 20 kHz	≤ 2 % ≤ 4 %	P01120025	
	E27	100 mA to 10 A _{PEAK} 500 mA to 100 A _{PEAK}				1 V _{PEAK} 1 V _{PEAK}			1 A / 100 mV 1 A / 10 mV			DC to 100 kHz	≤ 3 % ≤ 4 %	P01120027	
 <p>Ø 26 mm 138 mm 49 mm</p>	MH60	0.01 A to 140 A _{PEAK}				1.4 V _{PEAK}			10 mV/A			DC to 1 MHz	≤ 1.5 %	P01120612	
 <p>Ø 30 mm ou 2 x Ø 24 mm 224 mm 97 mm</p>	PAC15	0.5 A to 400 A _{AC} 0.5 A to 600 A _{DC}				600 mV _{AC/DC}			1 A / 1 mV			DC to 30 kHz	≤ 2 %	P01120115	
	PAC16	0.5 A to 40 A _{AC} 0.5 A to 60 A _{DC} 0.5 A to 400 A _{AC} 0.5 A to 600 A _{DC}				600 mV _{AC/DC} 600 mV _{AC/DC}			1 A / 10 mV 1 A / 1 mV			DC to 30 kHz	≤ 1.5 % ≤ 2 %	P01120116	
	PAC17	0.5 A to 60 A _{PEAK} 0.5 A to 60 A _{DC} 0.5 A to 600 A _{PEAK} 0.5 A to 600 A _{DC}				600 mV _{PEAK} 600 mV _{PEAK}			1 A / 10 mV 1 A / 1 mV			DC to 30 kHz	≤ 1.5 % ≤ 2 %	P01120117	
 <p>Ø 39 mm ou 2 x Ø 25 mm ou 2 x (50 x 5) mm 236.5 mm 97 mm</p>	PAC25	0.5 A to 1000 A _{AC} 0.5 A to 1400 A _{DC}				1.4 V _{AC/DC}			1 A / 1 mV			DC to 30 kHz	≤ 4 %	P01120125	
	PAC26	0.5 A to 100 A _{AC} 0.5 A to 150 A _{DC} 0.5 A to 1000 A _{AC} 0.5 A to 1400 A _{DC}				1.5 V _{AC/DC} 1.4 V _{AC/DC}			1 A / 10 mV 1 A / 1 mV			DC to 30 kHz	≤ 1.5 % ≤ 4 %	P01120126	
	PAC27	0.5 A to 150 A _{PEAK} 0.5 A to 150 A _{DC} 0.5 A to 1400 A _{PEAK} 0.5 A to 1400 A _{DC}				1.5 V _{PEAK} 1.4 V _{PEAK}			1 A / 10 mV 1 A / 1 mV			DC to 30 kHz	≤ 1.5 % ≤ 4 %	P01120127	

(2) Cable + electronic unit with Ø 4 mm safety plugs with 19 mm spacing for the K Series

MA110 - MA130

REF.: P01120660 P01120663
 REF.: P01120661
 REF.: P01120662

600 V CAT IV 1000 V CAT III 80 mA 3 kAac 4 calibres IP 67

MA200

REF.: P01120570
 REF.: P01120571
 REF.: P01120572

600 V CAT IV 1000 V CAT III 1 MHz

A110 - A130

REF.: P01120630 P01120633
 REF.: P01120631
 REF.: P01120632

1000 V CAT IV 80 mA 30 kAac 4 calibres IP 67



★ STRENGTHS

- For multimeters, loggers, oscilloscopes, etc.
- No magnetic saturation constraints: excellent linearity, low phase shift, wide dynamic range for measurement
- Flexibility of the sensors for easier clamping of the conductor to be measured
- Compact instruments which are easy to position in residential or industrial electrical cabinets
- Click system for opening and closing the core even when handling with safety gloves

+ ADDITIONAL INFO

MA110 model & A110 model

- Measures from 80 mA
- Can be connected to the AC voltage input (mVAC / VAC) of any multimeter or measuring instrument equipped with Ø 4 mm female banana plugs
- Can be powered by batteries or via a standard external power supply
- Equipped with an automatic power-off system which can be deactivated at start-up to perform long-duration measurement campaigns
- Possesses 3 LEDs (green, yellow and orange) indicating, respectively, the power-supply status, status of the automatic power-off function and measurement capacity overruns

MA130 three-phase model & A130 three-phase model



- Can be connected to the AC voltage inputs (mVAC / VAC) of any power analyser, logger or measuring instrument equipped with BNC plugs

MA200 model

- Equipped with a BNC output and can be connected to all types of oscilloscopes
- Offers wide bandwidth
- Particularly suitable for viewing transient signals, control signals, the tripping current for thyristors or the output signal from an electronic power supply

📦 CONTENTS

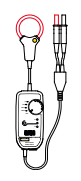
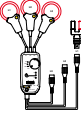
- **MA110 or A110** delivered with 2 x 1.5V LR6 alkaline batteries, 1 safety datasheet, 1 verification certificate
- **MA130 or A130** delivered with 2 x 1.5V LR6 alkaline batteries, 1 safety datasheet, 1 verification certificate, 1 set of coloured rings for foolproofing/identification of the cables, 3 female BNC/Ø 4 mm male plug adapters
- **MA200** delivered with 1 x 9 V battery, 1 verification certificate

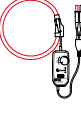
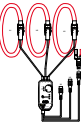
Series	Model	Input					Output - Connection					Specific Features					Reference	
		Very low current	Low current	Medium current	High current	Alternating current	Direct current	Current	Voltage	Cable + ø 4 mm safety plugs	Female ø 4 mm sockets	BNC connector (coaxial)	Transformation ratio (Input/Output)	Output protected against overvoltages	Automatic DC zero	Power measurement (low phase shift)		Bandwidth (frequency in Hz)
	MA110 3-30-300-3000/3 (17 cm / Ø 4.5 cm)		0.08 A...3 A 0.5 A...30 A 0.5 A...300 A 0.5 A...3000 A					3 V _{AC}				1 V/A 100 mV/A 10 mV/A 1 mV/A				10 Hz to 10 kHz 10 Hz to 20 kHz 10 Hz to 20 kHz 10 Hz to 20 kHz	≤ 1%	P01120660
	MA110 3-30-300-3000/3 (25 cm / Ø 7 cm)		0.08 A...3 A 0.5 A...30 A 0.5 A...300 A 0.5 A...3000 A					3 V _{AC}				1 V/A 100 mV/A 10 mV/A 1 mV/A				10 Hz to 10 kHz 10 Hz to 20 kHz 10 Hz to 20 kHz 10 Hz to 20 kHz	≤ 1%	P01120661
	MA110 3-30-300-3000/3 (35 cm / Ø 10 cm)		0.08 A...3 A 0.5 A...30 A 0.5 A...300 A 0.5 A...3000 A					3 V _{AC}					1 V/A 100 mV/A 10 mV/A 1 mV/A				10 Hz to 10 kHz 10 Hz to 20 kHz 10 Hz to 20 kHz 10 Hz to 20 kHz	≤ 1%
	MA130 30-300-3000/3 (25 cm / Ø 7 cm)		0.5 A...30 A 0.5 A...300 A 0.5 A...3000 A					3 V _{AC}				100 mV/A 10 mV/A 1 mV/A				10 Hz to 20 kHz 10 Hz to 20 kHz 10 Hz to 20 kHz	≤ 1%	P01120663
	MA200 30-300/3 (17 cm / Ø 4.5 cm)		0.5 A...45 A _{PEAK} 0.5 A...450 A _{PEAK}					4.5 V _{PEAK}				100 mV/A 10 mV/A					≤ 1% + 0.3 A	P01120570
	MA200 30-300/3 (25 cm / Ø 7 cm)		0.5 A...45 A _{PEAK} 0.5 A...450 A _{PEAK}					4.5 V _{PEAK}				100 mV/A 10 mV/A				5 Hz to 1 MHz	≤ 1% + 0.3 A	P01120571
	MA200 3000 /3 (35 cm / Ø 10 cm)		0.5 A...4500 A _{PEAK}					4.5 V _{PEAK}				1 mV/A					≤ 1% + 0.3 A	P01120572
	A110 3-30-300-3000/3 (45 cm / Ø 14 cm)		0.08 A...3 A 0.5 A...30 A 0.5 A...300 A 0.5 A...3000 A					3 V _{AC}				1 V/A 100 mV/A 10 mV/A 1 mV/A				10 Hz to 10 kHz 10 Hz to 20 kHz 10 Hz to 20 kHz 10 Hz to 20 kHz	≤ 1%	P01120630
	A110 3-30-300-3000/3 (80 cm / Ø 25 cm)		0.08 A...3 A 0.5 A...30 A 0.5 A...300 A 0.5 A...3000 A					3 V _{AC}				1 V/A 100 mV/A 10 mV/A 1 mV/A				10 Hz to 10 kHz 10 Hz to 20 kHz 10 Hz to 20 kHz 10 Hz to 20 kHz	≤ 1%	P01120631
	A110 30-300-3000-30000/3 (120 cm / Ø 38 cm)		0.5 A...30 A 0.5 A...300 A 0.5 A...3000 A 0.5 A...30000 A					3 V _{AC}				100 mV/A 10 mV/A 1 mV/A 0.1 mV/A				10 Hz to 5 kHz 10 Hz to 20 kHz 10 Hz to 20 kHz 10 Hz to 20 kHz	≤ 1%	P01120632
	A130 30-300-3000/3 (80 cm / Ø 25 cm)		0.5 A...30 A 0.5 A...300 A 0.5 A...3000 A					3 V _{AC}				100 mV/A 10 mV/A 1 mV/A				10 Hz to 20 kHz 10 Hz to 20 kHz 10 Hz to 20 kHz	≤ 1%	P01120633

ACCESSORIES / REPLACEMENT PARTS FOR CURRENT SENSORS

MiniFlex® MA110 / MA130

AmpFlex® A110 / A130

E25 / E27

MH60

PAC15/16/17 & PAC25/26/27

- Mains adapter / µUSB-B cable P01651023
 - 110 V-240 V 50/60 Hz mains power pack, USB type A female 5V 1A
 - Charging and connection cable, USB type A male - USB type Micro-B male 1.80 m

MH60

- Spare rechargeable battery P01296049Z

MN73 / C173 / B102

- AN1 artificial neutral box P01197201

E1N / E3N / E6N

- Mains adapter P01101965

K SERIES

- Mains adapter P01101966

PAC10/11/12/20/21/22

- Mains adapter P01101967

AmpFlex® A100

- Mains adapter P01101968

MiniFlex® MA100

- Mains adapter P01102086

MiniFlex MA200

- Mains adapter P01102087

See all the accessories on page 150

LABORATORY & EDUCATIONAL INSTRUMENTATION

INFO AND ADVICE
 TRAINING BENCHES
 TRAINING CASES

144
 146
 147

Electricity, electronics, physics, industrial maintenance & the environment: these are disciplines where **measurement is crucial for identifying and understanding**, theoretical phenomena through practical experience. We offer **simple, educational equipment to help students to learn** about subjects ranging from the study of electrical signals to the maintenance of electrical systems.

STUDYING SIMPLE ELECTRICAL PHENOMENA

In Electronics training, students discover the techniques using electrical signals to capture, transmit, process, store and view data. To help them, **the electrical quantities may be generated by decade boxes or simulation cases**. These quantities are measured by traditional measuring instruments such as voltmeters, ammeters, wattmeters and multimeters. These resistance, capacitance or inductance decade boxes are passive elements for insertion into test or development circuits in order to obtain the required resistance, capacitance or inductance values by combination.

COMPLIANCE WITH THE IEC 61010-1 STANDARD

These decade boxes comply with the IEC 61010-1 safety standard which establishes the safety rules for electrical measuring, control and laboratory instruments. This standard defines the normal environmental conditions of use:

- Indoor use
- Altitude up to 2,000 m
- Temperature from 5 °C to 40 °C
- Maximum relative humidity of 80 % at temperatures up to 31 °C, with a linear decrease down to 50 % relative humidity at 40 °C
- Fluctuations of the network supply voltage not exceeding $\pm 10\%$ of the rated voltage
- Normal presence of transient over voltages on the network power supply



PRACTICAL APPLICATIONS ENCOURAGE SUCCESSFUL LEARNING

Electrical installation cases, power and harmonics cases, microwave test benches and an **infrared thermography bench**, Chauvin Arnoux provides students with **ready-to-use** educational models which are ideal for a large number of experiments.

Their overall design aims to ensure simple use and measurements. **Delivered with a guide containing practical** exercises accompanied by the corresponding theoretical elements, these training cases enable students to boost their knowledge with practical skills likely to prove useful during their careers.

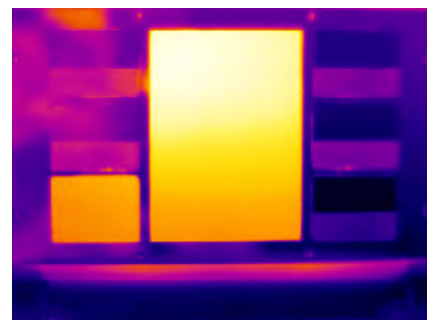

Quantity	Unit
Resistance R	Ω (ohm)
Current I	A (ampere)
Voltage V	V (volt)
Power P	W (watt)
Capacitance C	F (farad)
Inductance L	H (henry)



RESISTOR BOXES



★ STRENGTHS

- Rotary selection switch
- Mechanical stop preventing accidental switching from 10 to 1
- Foolproofed male earth/ground terminal

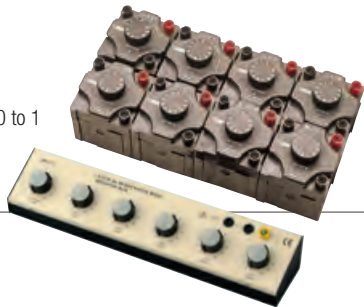

⚙️ SPECIFICATIONS

	References
1 decade	
0.1 to 1 Ω	P03197521A
1 to 10 Ω	P03197522A
10 to 100 Ω	P03197523A
100 to 1000 Ω	P03197524A
1 to 10 kΩ	P03197525A
10 to 100 kΩ	P03197526A
100 to 1000 kΩ	P03197527A
1 to 10 MΩ	P03197528A
BR 04 : 4 decades, 1 Ω to 10 kΩ	P01197401
BR 05 : 5 decades, 1 Ω to 100 kΩ	P01197402
BR 06 : 6 decades, 1 Ω to 1 MΩ	P01197403
BR 07 : 7 decades, 1 Ω to 10 MΩ	P01197404

📦 CONTENTS

- 1-decade box delivered with 1 black male Ø 4 mm safety cable 25 cm long with rear connection
- The BR 04/05/06/07 boxes are delivered with the user's manual only.

⚙️ ACCESSORIES / REPLACEMENT PARTS

1 black male Ø 4 mm safety cable 25 cm long with rear connection	P01295056
Black Ø 4 mm male jumper (x10)	P01101892A

IEC/EN6110-1 - 150 V CAT II - PoI 2 - 50 V CAT III

INDUCTANCE BOXES



⚙️ SPECIFICATIONS

	References
BL 07 : 7 decades from 1 µH to 10 H	P01197451

📦 CONTENTS

BL07 delivered with the user's manual only

CAPACITANCE BOXES



★ STRENGTHS

Elements for mechanical and electrical assemblies

- Selection by rotary switch with contacts
- Typical accuracy: 2%

1-decade boxes

- 3 boxes with 11-position switch (including position 0)
- 2 safety terminals Ø 4mm and one earth/ground terminal
- Dimensions : 72x72x90 mm



⚙️ SPECIFICATIONS

	References
1 decade	
0.01 to 0.1 µF	P03199613A
0.1 to 1 µF	P03199612A
1 to 10 µF	P03199611A

📦 CONTENTS

1-decade box delivered with:

- 1 black male Ø 4 mm safety cable 25 cm long with rear connection

⚙️ ACCESSORIES / REPLACEMENT PARTS

1 black male Ø 4 mm safety cable 25 cm long with rear connection	P01295056
Black Ø 4 mm male jumper (x10)	P01101892A

IEC/EN6110-1 - 150 V CAT II - PoI 2 - 50 V CAT III

100 mV SAFETY SHUNTS IN DOUBLE-INSULATED CASING



★ STRENGTHS

- 4-wire measurement
- Red "current" terminals
- Black "voltage" terminals



⚙️ SPECIFICATIONS

	References
1 A	P01165221
5 A	P01165222
10 A	P01165223
20 A	P01165224
30 A	P01165225

📦 CONTENTS

Shunt delivered with user's manual only.

IEC/EN6110-1 - 150 V CAT II - PoI 2 - 50 V CAT III

CA 1875

TP
GUIDE

REF.: PO1651620



★ STRENGTHS

- Highlighting of the various possible errors in thermography: problems linked to emissivity, spatial resolution, angle of measurement, transmission or reflection
- Simple use and simple measurements
- Delivered with a booklet of practical exercises accompanied by the corresponding theoretical principles

⚙️ SPECIFICATIONS

	CA 1875
Emissivity of materials	The influence of emissivity on temperature measurement is demonstrated using sheets of different materials
Positioning	Visual demonstration of the influence on temperature measurement of camera positioning in relation to the target
Reflection and transmission	Visual demonstration of reflection and transmission phenomena and their influence
Spatial resolution	Detection of minimum areas for temperature measurement according to the distance from the target
Power supply	230 V – 50 / 60Hz

📦 CONTENTS

CA 1875 delivered in a bag with:

- 1 mains power supply
- Test sheets
- 1 booklet presenting the theoretical principles and practical exercises

CA 6710

ELECTRICAL
INSTALLATIONS

REF.: PO1145901



★ STRENGTHS

- Ideal for learning about electrical safety measurements
- Simulation of measurements on electrical installations
- Depressurization valve for air transport

⚙️ SPECIFICATIONS

	CA 6710
Standards illustrated	NF C 15-100, VDE 0100, IEE 16th, IEC 64-8, ÖVE EN-1, RBT MIE, NIN/NIV...
Simulation of earthing systems	TT, TN and IT
Measurement simulations	Earth, resistivity, loops (earth and internal), insulation, RCD tests (30 mA / 300 mA), current / leakage current
Fault simulations	Phase / neutral or earth interruptions, neutral / earth reversal, leakage current
Electrical safety	Cat. II 230 V
Dimensions	490 x 395 x 195 mm
Weight	10 kg

📦 CONTENTS

CA 6710 delivered with:

- 1 x Schuko-type FR-DE mains power cable
- 6 black safety leads 25 cm long with rear connection
- 1 universal adapter for mains power sockets
- 1 FR/DE adapter for mains power sockets

⚙️ ACCESSORIES / REPLACEMENT PARTS

Set of 6 black Ø 4 male safety leads 25 cm long with rear connection	P01295212
1 FR/DE adapter for mains power sockets	P01101981

POWER & HARMONICS

REF.: P0INC5003



POWER & HARMONICS



★ STRENGTHS

- Hazard-free simulation of a network and a three-phase load
- Variable currents, voltages, phase shift and THD

⚙️ SPECIFICATIONS

	POWER & HARMONICS
Network simulations	SINGLE or THREE-PHASE (230 V mains power supply)
Measurement simulations	U, I, W, W/h, var, ϕ , THD,...
Voltage	Mains $\pm 15\%$
Current	1, 2, 5, 10, 20 A $\pm 10\%$
Voltage variation*	+ 8 % ; -10 %
Current phase shift*	30°, 45°, 60° $\pm 5^\circ$ inductive or capacitive
Harmonic distortion on current and voltage*	Network level, 15 %, 25 % and variable
Phase outage	Yes
Power supply	Mains 230 V - 2 P + E socket
Electrical safety	IEC 61010 300 V Cat II pollution 2
Dimensions	490 x 395 x 195 mm
Weight	10 kg

* on phase 1

+ ADDITIONAL INFO

- The current sensors are not delivered with the training case.

📦 CONTENTS

- Case delivered with:
- 1 mains power cable

⚙️ ACCESSORIES / REPLACEMENT PARTS

Measurement leads

page 150

BDH R100

REF.: PO1275101



TP
GUIDE



GUNN ORITEL CF 204
power supply

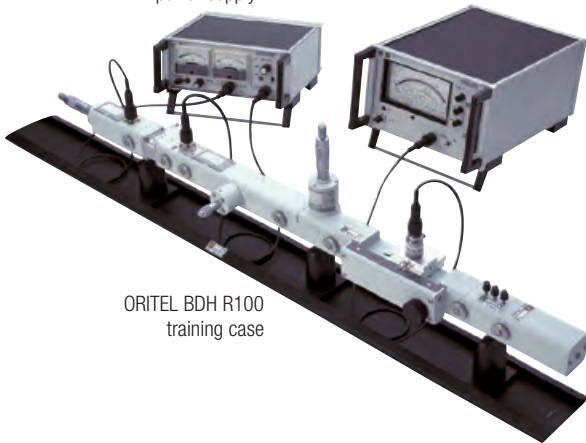

ORITEL BDH R100
training case

ELEMENTS FOR FREE-SPACE PROPAGATION

		Reference
1	20 dB ANC 100/20 horn antenna	P01275326
2	15 dB ANC 100/15 dB horn antenna	P01275304
3	10 dB ANC 100/10 horn antenna	P01275325
4	RRL100 passive radar responder	P01275333
5	DR100 reflector disk	P01275334
6	AND100 dielectric antenna	P01275329
7	ASP100 patch antenna	P01275328
8	ANF100 adjustable slot antenna	P01275332
	ANF100F fixed slot antenna	P01275331
	IANF100 iris for adjustable slot antenna	P01275330
	ANP100 adjustable parabolic reflector	P01275327
9	ANP100F fixed parabolic reflector	P01275335

★ STRENGTHS

- Dedicated to teaching about 8.5 to 9.6 GHz microwaves with guided propagation
- WR90/R100 waveguide equipped with a quick mounting system
- Supplied with detailed course, teaching and lab work material
- Various accessories for setting up a wide range of experiments

⚙️ SPECIFICATIONS

	BDH R100
Main possible experiments	
Study	GUNN oscillator
	Impedance
	Wavelength
Measurements	Frequency
	Standing wave ratio
Readings	Quadratic law of a detector

📦 CONTENTS

BDH R100 delivered in a case with:

- 1 ORITEL OSG 100 GUNN diode oscillator
- 1 ORITEL ISO 100 ferrite isolator
- 1 ORITEL MOD 100 PIN diode modulator
- 1 ORITEL ATM 100 variable attenuator
- 1 ORITEL OND 100 cavity wavemeter with curve
- 1 ORITEL LAF 100 measuring line
- 1 ORITEL ADZ 100/3 impedance adapter
- 1 ORITEL TGN 100 waveguide-to-coaxial transition element
- 1 ORITEL DEN 100 coaxial detector
- 1 ORITEL CHG 100 adapted load
- 1 ORITEL CC 100 short-circuit plate
- 3 ORITEL SUP 100 guide supports



ADDITIONAL COMPONENTS

		Reference
1	ORITEL RD 100 displacement copy (for ORITEL LAF 100 measuring line)	P01275302
2	DPH100 micrometer phase shifter	P01275340
3	JTG100 rotating joint	P01275338
4	CIR100 ferrite circulator	P01275344
5	DEG100 parallel detector on guide	P01275345
6	PEH100 E-H positioner	P01275358
7	GD100/180 180 mm straight waveguide	P01275350
8	COE100/H high plane E bend	P01275346
	COE100/B low plane E bend	P01275347
	COH100 plane H bend	P01275348
9	CCM100 micrometer short-circuit	P01275351
10	Calibrated attenuator	P01275339
11	LAZ100 movable impedance adapter	P01275352
12	KED100 dielectric kit	P01275353
13	CDT100 multi-hole directional coupler	P01275341
	ICDT100/30: 30 dB iris for multi-hole coupler	P01275343
14	CAB100: 1 m coaxial cable	P01275357

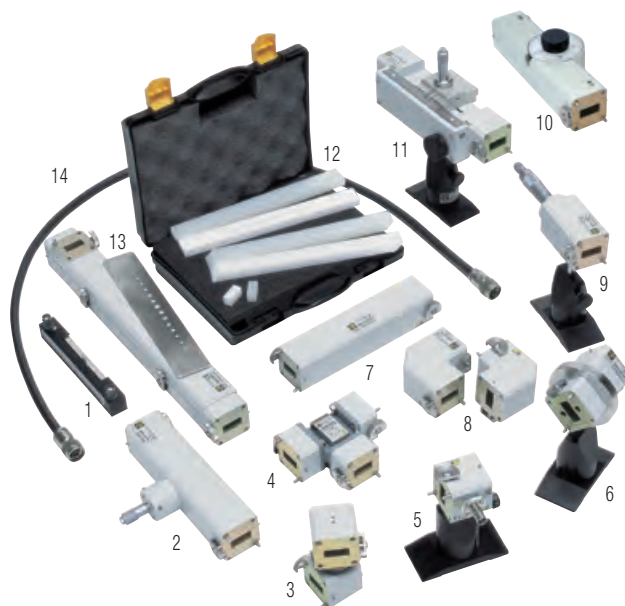

ACCESSORIES / REPLACEMENT PARTS

		Reference
ORITEL OSG 100 GUNN diode oscillator	Voltage: 10 VDC - Power: +17 dBm	P01275307
ORITEL MOD 100 PIN diode modulator	Modulation depth > 50% for I = +10 mA	P01275309
ORITEL OND 100 cavity wavemeter with curve	Reading accuracy: 5 MHz	P01275311
ORITEL LAF 100 measuring line	Residual SWR: < 1.05	P01275312
ORITEL DEN 100 coaxial detector	SWR: < 1.3 - Max. power: +19 dBm	P01275315
ORITEL ISO 100 ferrite isolator	Insulation: > 20 dB	P01275308
ORITEL ATM 100 micrometer attenuator	Attenuation: > 20 dB - Max. power: 1 W average	P01275310
ORITEL ADZ 100/3 impedance adapter	Number of transverse plates: 3	P01275313
ORITEL TGN 100 WAVEGUIDE-TO-COAXIAL TRANSITION ELEMENT	SWR: < 1.25	P01275314
ORITEL CHG 100 adapted load	SWR: < 1.05	P01275316
ORITEL CGX 100/20 dB cross coupler	Coupling: 20 dB - Directivity: 15 dB typ.	P01275305
IRIS 100 coupling iris (for CGX100)	20 and 30 dB coupling	P01275306
ORITEL ANC 100/15 dB horn antenna	Gain: 15 dB Flange: UBR 100/UG 39	P01275304
ORITEL AFR 100	Compatible with UBR 100 / UG 39 flanges	P01275301
ORITEL RD 100 displacement copy	For ORITEL LAF 100 measuring line	P01275302

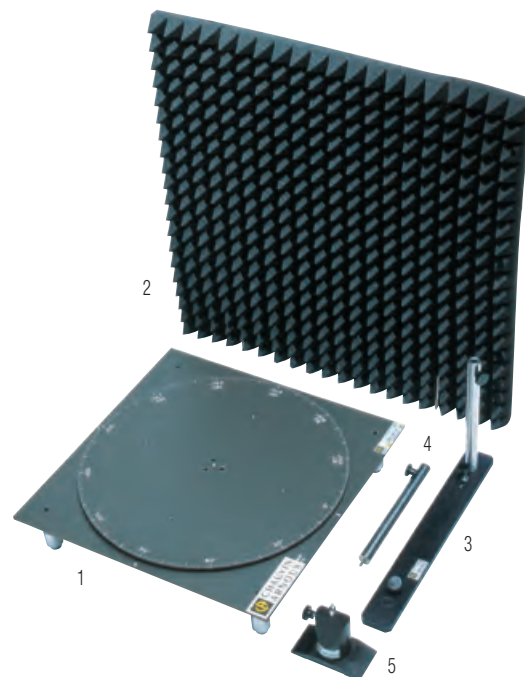

ACCESSORIES / REPLACEMENT PARTS

		Reference
1	Manual rotating platform – PTM100	P01275359
2	Set of 2 absorber panels – ABS100	P01275362
3	Antenna support – SAN100	P01275360
4	Antenna support rod	P01275349
5	Waveguide support – SUP100	P01275318
	Experiment frame	P01275361







* You are advised to use the GUNN CF204 power supply to power your GUNN diode oscillators.

CONNECTORS 150
PRODUCT-SPECIFIC ACCESSORIES 152

ADAPTERS AND SENSORS 153
PROTECTION, STORAGE AND TRANSPORT 154
FUSES 156

Ø 4 MM BANANA CONNECTORS

MEASUREMENT LEADS



Model	Description
MOULDED	
	<p>Set of 2 red/black moulded PVC leads P01295450Z</p> <p>Insulated straight male plug Ø 4 mm – Insulated straight male plug Ø 4 mm</p> <ul style="list-style-type: none"> • 15 A • 1.5 m • 1000 V CAT IV
	<p>Set of 2 red/black moulded silicone leads P01295452Z</p> <p>Insulated straight male plug Ø 4 mm – Insulated straight male plug Ø 4 mm</p> <ul style="list-style-type: none"> • 15 A • 1.5 m • 1000 V CAT IV
	<p>Set of 2 red/black moulded PVC leads P01295451Z</p> <p>Insulated straight male plug Ø 4 mm – Insulated elbowed male plug Ø 4 mm</p> <ul style="list-style-type: none"> • 15 A • 1.5 m • 1000 V CAT IV
	<p>Set of 2 red/black moulded silicone leads P01295453Z</p> <p>Insulated straight male plug Ø 4 mm – Insulated elbowed male plug Ø 4 mm</p> <ul style="list-style-type: none"> • 15 A • 1.5 m • 1000 V CAT IV
STANDARD	
	<p>Set of 2 red/black PVC leads P01295288Z</p> <p>Insulated straight male plug Ø 4 mm – Insulated straight male plug Ø 4 mm</p> <ul style="list-style-type: none"> • 15 A • 1.5 m • 600 V CAT IV / 1000 V CAT III
	<p>Set of 2 red/black PVC leads P01295289Z</p> <p>Insulated straight male plug Ø 4 mm – Insulated elbowed male plug Ø 4 mm</p> <ul style="list-style-type: none"> • 15 A • 1.5 m • 600 V CAT IV / 1000 V CAT III
	<p>Set of 2 red/black PVC leads P01295290Z</p> <p>Insulated straight male plug Ø 4 mm with rear connection Insulated straight male plug Ø 4 mm with rear connection</p> <ul style="list-style-type: none"> • 20 A • 2 m • 600 V CAT III

LEADS WITH TEST PROBES





Model	Description
FOR CAT IV & CAT III INSTALLATIONS	
	<p>Set of 2 red/black PVC test-probe leads P01295455Z</p> <p>Insulated straight male plug Ø 4 mm</p> <ul style="list-style-type: none"> • 15 A • 1.5 m • 600 V CAT IV / 1000 V CAT III
	<p>Set of 2 red/black PVC test-probe leads P01295456Z</p> <p>Insulated elbowed male plug Ø 4 mm</p> <ul style="list-style-type: none"> • 15 A • 1.5 m • 600 V CAT IV / 1000 V CAT III
	<p>Set of 2 IP2X PVC leads for multimeters P01295461Z</p> <p>Complies with NF C 18-510 and IEC 61010-031+A1:2008</p> <ul style="list-style-type: none"> • IP2X test probe • Insulated elbowed male plug Ø 4 mm • 15 A • 1.5 m • 600 V CAT IV / 1000 V CAT III

Ø 4 MM BANANA CONNECTORS

LEADS WITH TEST PROBES

Model	Description
FOR CAT II & LOWER INSTALLATIONS	
	<p>Measurement leads + test probes kit P01295475Z</p> <p>comprising:</p> <p>Set of 2 red/black PVC leads Insulated straight male plug Ø 4 mm – Insulated elbowed male plug Ø 4 mm</p> <ul style="list-style-type: none"> • 15 A • 1,5 m • 600 V CAT IV / 1000 V CAT III <p>+ Set of 2 moulded test probes Ø 4 mm</p> <ul style="list-style-type: none"> • Female plug Ø 4 mm • CAT II 300 V
	<p>Measurement leads + test probes kit P01295474Z</p> <p>comprising:</p> <p>Set of 2 red/black PVC leads Insulated straight male plug Ø 4 mm – Insulated elbowed male plug Ø 4 mm</p> <ul style="list-style-type: none"> • 15 A • 1,5 m • 600 V CAT IV / 1000 V CAT III <p>+ Set of 2 moulded test probes Ø 2 mm</p> <ul style="list-style-type: none"> • Female plug Ø 4 mm • CAT II 300 V

REMOVABLE TEST PROBES

Model	Description
FOR CAT IV & CAT III INSTALLATIONS	
	<p>Set of 2 red/black moulded test probes P01295454Z</p> <ul style="list-style-type: none"> • Female plug Ø 4 mm • 15 A • CAT IV / CAT III 1000 V
	<p>Set of 2 red / black moulded Ø 2 test probes P01295491Z</p> <ul style="list-style-type: none"> • Adapted to the measurement of modular systems on DIN rail • Female plug Ø 4 mm • 10 A • CAT IV 1000 V
FOR CAT II & LOWER INSTALLATIONS	
	<p>Set of 2 moulded test probes Ø 4 mm P01295458Z</p> <ul style="list-style-type: none"> • Female plug Ø 4 mm • 15 A • CAT II 300 V
	<p>Set of 2 moulded test probes Ø 2 mm P01295460Z</p> <ul style="list-style-type: none"> • Female plug Ø 4 mm • 15 A • CAT II 300 V

PRODUCT-SPECIFIC ACCESSORIES

Model	Description
FOR MULTIMETERS OR TESTERS WITH + TERMINAL ON TOP	

Red test probe Ø 4 mm



P01103060Z
removable for tester or DMM
Use as "hands-free" test probe
• Male plug Ø 4 mm
• 600 V CAT IV

FOR CA 745 TESTER OR REMOTE CONTROL PROBE	
--	--

Red test probe Ø 4 mm



P01103061Z
removable with locking pin
For tester or remote-control probe
• Male plug Ø 4 mm
• 600 V CAT IV

FOR CA 745N, CA 755 AND CA 757	
---------------------------------------	--

Set of red/black test probes



P01102152Z
• CAT III/IV

Set of red/black test probes



P01102153Z
• Ø 2 mm
• CAT II

Set of red/black test probes



P01102154Z
• Ø 4 mm
• CAT II

FOR CA 704, CA 740 AND CA 760 VOLTAGE ABSENCE TESTERS	
--	--



Removable red test probe
P01103059Z
• Female plug Ø 4 mm
• 600 V CAT IV

Black test-probe lead
P01295464Z
Insulated elbowed female plug Ø 4 mm
Length 0.85 m
• 600 V CAT IV

Model	Description
FOR ALL VOLTAGE ABSENCE TESTERS, CA 74X/XN SERIES / CA 76X/XN SERIES	

Set of 2 PVC IP2X leads



P01295463Z
for CA 760 and CA 704 VATs
Complies with NF C 18-510 and IEC 61010-031+A1:2008
• IP2X test probe Ø 2 mm
• Elbowed female plug Ø 4 mm
• 15 A
• 1.5 m
• 600 V CAT IV



Red removable test probe
P01102008Z
• Female plug Ø 4 mm
• CEI 61243-3

Set of 2 IP2X leads for CA 740N and CA 760N VATs



P01295462Z
• IP2X test probe Ø 4 mm
• Elbowed female plug Ø 4 mm
• 15 A
• NF C 18-510 / CEI 61243-3 1000 V
• 1.5 m

Also available:
P01295285Z
- 0.25 m lead (red)
- 0.85 m lead (black)

Set of IP2X accessories for VAT



P01102121Z
• 2 x IP2X Ø 4 mm test probes
• 1 point-point cable, L = 1.10 m

CA 751 measurement adapter



P01101997Z
• For 2P+E sockets

Model	Description
FOR CA 771 & CA 773 VOLTAGE ABSENCE TESTERS	

Set of 2 red/black IP2X test probes Ø 4 mm



P01102128Z
Female plug Ø 4 mm
CEI 61423-3 1000 V

Set of 2 red/black IP2X test probes



P01102127Z
Female plug Ø 4 mm
1000 V CAT IV

Set of 2 red/black test probes



P01102123Z
Female plug Ø 4 mm
1000 V CAT IV

Set of 2 red/black test probes Ø 2 mm with crystal



P01102124Z
Female plug Ø 4 mm
CEI 61423-3 1000 V

Set of 2 red/black test probes Ø 4 mm











P01102125Z
Female plug Ø 4 mm
CEI 61423-3 1000 V

Protective cap for test probe









P01102126Z

OTHER ACCESSORIES

Model	Description
FOR CAT IV & CAT III INSTALLATIONS	
Set of 2 red/black crocodile clips	
	P01295457Z • 15 A • 1000 V CAT IV
Set of leads and measuring accessories for electricians	
	P01295459Z • 2 x 1000 V CAT IV moulded test probes • 2 x 1.5 m 1000 V CAT IV red/black moulded leads with straight male plug – elbowed male plug • 2 x red/black 1000 V CAT IV crocodile clips • 2 x 300 V CAT II moulded test probes Ø 4 mm
Set of 2 red/black magnetized test probes	
	P01103058Z For voltage measurement only Ø test probe: 6.6 mm – Elbowed female plug Ø 4 mm • 1000 V CAT III / 600 V CAT IV
Set of 2 red/black crocodile wire grips	
	P01102053Z • 20 A • 1000 V CAT III
Set of 2 adapters	
	P01102101Z Insulated female BNC plug - Red/black - insulated male plugs Ø 4 mm with 19 mm spacing • 600 V CAT III
Set of 2 adapters	
	HX0107 Insulated BNC male plug - Insulated red/black female plugs Ø 4 mm spacing 19 mm • 600 V CAT III
BNC coaxial connection cable	
	HX0106 Insulated BNC male plug - Insulated BNC male plug Impedance 50 Ω 1 m • 600 V CAT III
PVC lead	
	AG1066-Z Insulated male BNC plug - Insulated straight male banana plugs Ø 4 mm (red/black) with rear connection • 1 m • 500 V CAT III

Model	Description
FOR CAT II & LOWER INSTALLATIONS	
Set of 3 measurement adapters for housing	
	P01102114Z 2 red/black insulated straight male plugs Ø 4 mm • E27 screw socket • B22 bayonet socket • 2-pole mains socket (P/N) • 250 V CAT II
CA 753: Measurement adapter for 2P+E socket	
	P01191748Z • Suitable for European and Schuko sockets • Can be used for measurements on the P (Phase), N (Neutral) and PE (Earth) conductors in total safety • Guarantees mechanical and electrical contact with all test probes (Ø2, Ø4, IP2x, etc.) • Shows the presence of a P-N voltage (> 200 V) and indicates the phase position • IEC 61010 230 V CAT II
Current lead equipped with a French 2P+E mains socket	
	P03295509 • For inserting an ammeter in series in total safety • For measuring the current with a current clamp without having to remove the outer sheath of the power supply cable
Measurement lead for French and German 2P+E mains sockets	
	P06239307 For direct measurement on a mains socket Quick implementation and reliable connections
Set of 2 red/black insulation-piercing clips	
	P01102055Z • 30 V AC, 60 V DC
CMS clamp	
	HX0064 Copper-gold-plated beryllium contacts Output via male plugs Ø 4 mm • 1.2 m • SELV
Set of 2 adapters	
	P01101846 Red/black insulated male BNC – female sockets Ø 4 mm with 19 mm spacing • 500 V CAT I, 150 V CAT III
Set of 2 adapters	
	P01101847 Red/black insulated BNC male – male sockets Ø 4 mm with 19 mm spacing • 500 V CAT I, 150 V CAT III
SHT40KV high-voltage probe for multimeters	
	P01102097 Maximum rated voltage: 40 kVDC, 28 kVRMS or 40 kVPEAK (50/60 Hz) Input/output ratio: 1 kV / 1 V For multimeters with 10 MΩ input impedance • CAT I

Model	Description
EXTERNAL POWER SUPPLY & MAINS POWER PACK	
Set of 4 x 1.5 V LR06 rechargeable batteries with low self-discharge and charger	
	HX0053
Set of 4 x 1.5 V LR06 rechargeable batteries with low self-discharge	
	HX0051B
230 V / µUSB – B mains adapter	
	P01651023 • 110 – 240 V 50/60 Hz • Female USB type A, 5 V 1 A Charging and connection cable • Male USB type A – Male USB type µ-B • 1.8 m
ADAPTERS FOR TEMPERATURE MEASUREMENT SENSORS	
Set of 2 safety thermocouple adapters for multimeters	
	P01102106Z Female thermocouple plug – insulated red/black male plugs Ø 4 mm with 19 mm spacing
Safety adapter and K-sensor temperature probe	
	P01102107Z For multimeters and multimeter clamps equipped with a temperature measurement calibre with 19 mm-spaced banana inputs - Measurement range from -50 °C to +350 °C - Sensor length: approx. 100 cm
Pt100/Pt1000 sensor adapter for multimeters	
	HX0091 Female Pt100/Pt1000 plug – Red/black insulated male plugs Ø 4 mm

PROTECTION, STORAGE & TRANSPORT

SOFT CASES

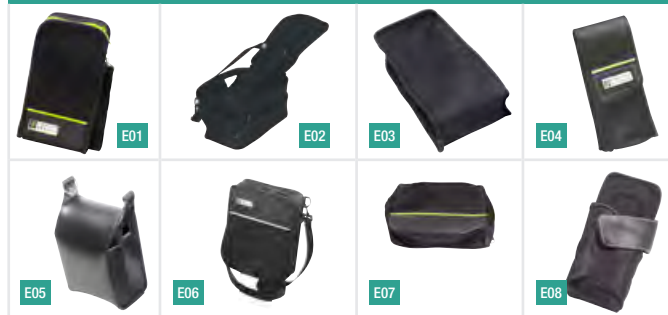

SHOULDER BAGS

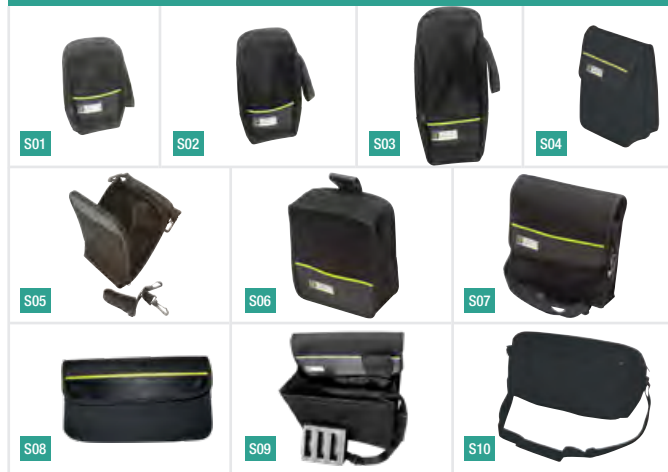

BAGS

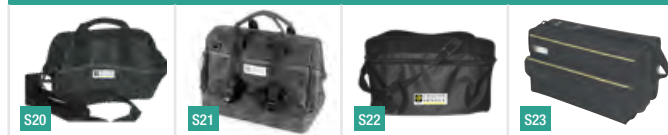

HARD CASES



MOUNTING SUPPORT



WATERPROOF SITE CASES



STORAGE ACCESSORY

STORAGE ACCESSORY REELING BOX REF.: P01102149

To make sure that your cables are never tangled. Can be used to store up to 3 m of cable (1 x 3 m / 2 x 1.5 m). Built-in magnet for easy mounting on any metal surface.



Photo	L x H x P	Reference	Additional information
SOFT CASES			
E01	110 x 220 x 45 mm	P01298065Z	
E02	125 x 210 x 120 mm	P01298049	Specific to one instrument or product range. See page 155
E03	125 x 265 x 60 mm	P01298043Z	
E04	180 x 75 x 45 mm	P01298012	
E06	190 x 250 x 60 mm	P01298055	
E07	250 x 190 x 80 mm	P01298051	
E08	70 x 185 x 30 mm	P01298007	
SHOULDER BAGS			
S01	120 x 200 x 60 mm	P01298074	Compatible with MultiFix
S02	120 x 245 x 60 mm	P01298075	Compatible with MultiFix
S03	120 x 320 x 60 mm	P01298076	Compatible with MultiFix
S04	150 x 230 x (40+40) mm	P01298032	
S05	165 x 250 x 60 mm	P06239502	
S06	180 x 220 x 75 mm	P01298036	
S07	225 x 270 x 70 mm	P01298033	
S08	240 x 140 x 130 mm	P01298006	
S09	355 x 255 x 235 mm	P01298056	
S10	360 x 200 x 140 + 360 x 160 x 35 mm	P01298061A	
BAGS			
S20	330 x 240 x 240 mm	P01298078	
S21	380 x 280 x 200 mm	P01298066	All-terrain waterproof bottom. 2 compartments and space for documents. Supplied with shoulder strap
S22	575 x 320 x 200 mm	P01298067	
S23	475 x 180 x 250 mm	P01298031	
HARD CASES			
M01	270 x 195 x 65 mm	P01298071	Equipped with foam inserts. Delivered with strap and keys
M02	285 x 210 x 80 mm	P01298037	Specific to one instrument or product range. See page 155
M03	285 x 210 x 80 mm	P01298037A	Specific to one instrument or product range. See page 155
M04	320 x 255 x 75 mm	P01298004	Equipped with foam inserts. Delivered with strap and keys
M05	320 x 255 x 75 mm	P01298011	Specific to one instrument or product range. See page 155
M07	440 x 310 x 135 mm	P01298072	Equipped with foam inserts. Delivered with strap and keys
WATERPROOF SITE CASES			
B01	272 x 248 x 130 mm	P01298068	Equipped with foam inserts
B02	272 x 248 x 182 mm	P01298069	Equipped with foam inserts

MULTIFIX MOUNTING ACCESSORY RÉF.: P01102100Z

When used with the compatible soft cases and bags, this helps you to transport and mount the measuring instruments for greater user comfort..



FUSES

Product	Standardized dimensions (mm)	Amperage	Reference
CA 10	6 x 32	8 A	P01297013
CA 1621	5 x 20	0.125 A	P01297099
CA 1631	5 x 20	0.125 A	P01297099
CA 4010	6 x 32	0.315 A	P03297509
CA 4010	6 x 32	16 A	P03297505
CA 4020	6 x 32	0.315 A	P03297509
CA 4020	6 x 32	16 A	P03297505
CA 403	6 x 32	0.315 A	P03297509
CA 404	6 x 32	1.25 A	P01297015
CA 405	6 x 32	6.3 A	P01297016
CA 5001	6 x 32	5 A	P01297035
CA 5001	6 x 32	0.5 A	P01297028
CA 5003	10 x 38	16 A	P01297037
CA 5003	6 x 32	1.6 A	P01297036
CA 5005	6 x 32	1 A	P01297039
CA 5005	6 x 32	10 A	P01297038
CA 5011	6 x 32	1 A	P01297039
CA 5011	6 x 32	10 A	P01297038
CA 5210	10 x 38	12 A	P01297021
CA 5210	6 x 32	0.4 A	P01297020
CA 5210G	10 x 38	12 A	P01297021
CA 5210G	6 x 32	0.4 A	P01297020
CA 5220	10 x 38	12 A	P01297021
CA 5220	6 x 32	0.4 A	P01297020
CA 5220G	10 x 38	12 A	P01297021
CA 5220G	6 x 32	0.4 A	P01297020
CA 5230G	10 x 38	12 A	P01297021
CA 5230G	6 x 32	0.5 A	P01297028
CA 5233	6 x 32	10A	AT0070
CA 5240G	10 x 38	12 A	P01297021
CA 5240G	6 x 32	0.5 A	P01297028
CA 5260G	6 x 32	0.1 A	P01297012
CA 5271	10 x 38	10 A	P01297096
CA 5273	10 x 38	10 A	P01297096
CA 5275	10 x 38	10 A	P01297096
CA 5275	6 x 32	0.63 A	P01297098
CA 5277	10 x 38	10 A	P01297096
CA 5277	6 x 32	0.63 A	P01297098
CA 5287	10 x 38	11 A	P01297092
CA 5287	10 x 38	0.44 A	P01297094
CA 5289	10 x 38	11 A	P01297092
CA 5289	10 x 38	0.44 A	P01297094
CA 5292	10x38	11A	P01297092
CA 6114 / 15N	6 x 32	3.15 A	P01297080
CA 6115N	5 x 20	2 A	P01297026
CA 6115N	6 x 32	3.15 A	P01297080
CA 6121	5 x 20	1 A	P01297031
CA 6121	5 x 20	4 A	P01297032
CA 6121	6 x 32	0.2 A	P01297033
CA 6240	6 x 32	12.5 A	P01297091
CA 6250	5 x 20	2 A	P01297090

Product	Standardized dimensions (mm)	Amperage	Reference
CA 6250	6 x 32	16 A	P01297089
CA 6421	6 x 32	0.1 A	P01297012
CA 6423	6 x 32	0.1 A	P01297012
CA 6425	6 x 32	0.1 A	P01297012
CA 6460	6 x 32	0.1 A	P01297012
CA 6462	6 x 32	0.1 A	P01297012
CA 6470	5 x 20	0.63 A	AT0094
CA 6471	5 x 20	0.63 A	AT0094
CA 6472	5 x 20	0.63 A	AT0094
CA 6501	6 x 32	0.2 A	P01297095
CA 6503	6 x 32	0.2 A	P01297095
CA 6511	6 x 32	1.6 A	P01297022
CA 65113	6 x 32	1.6 A	P01297022
CA 6521	6 x 32	0.63 A	P01297078
CA 6522	6 x 32	0.63 A	P01297078
CA 6523	6 x 32	0.63 A	P01297078
CA 6524	6 x 32	0.63 A	P01297078
CA 6525	6 x 32	0.63 A	P01297078
CA 6526	6 x 32	0.63 A	P01297078
CA 6528	6 x 32	0.200 A	P01297104
CA 6531	6 x 32	0.63 A	P01297078
CA 6532	6 x 32	0.63 A	P01297078
CA 6534	6 x 32	0.63 A	P01297078
CA 6536	6 x 32	0.63 A	P01297078
CA 6541	6 x 32	0.1 A	P01297072
CA 6541	8 x 50	2.5 A	P01297071
CA 6543	6 x 32	0.1 A	P01297072
CA 6543	8 x 50	2.5 A	P01297071
CA 6545	5 x 20	0.1 A	P03297514
CA 6547	5 x 20	0.1 A	P03297514
CA 6549	5 x 20	0.1 A	P03297514
CA5293	10 x 38	11A	P01297092
CdA 778N	6 x 32	2 A	P03297513
CdA 778N	6 x 32	10 A	P03297502
CdA100-A	6 x 32	0.4 A	P01297020
DETEC 220	5 x 20	0.315 A	P01297014
IMEG 500	5 x 20	0.2 A	P02297302
IMEG 500N	5 x 20	0.2 A	P02297302
LOCAT 110	5 x 20	0.1 A	P03297514
LOCAT 220	5 x 20	0.1 A	P03297514
MANIP W1	6 x 32	1.25 A	P01297015
MAN'X 500	6 x 32	2 A	P03297513
MAN'X 500	6 x 32	16 A	P03297505
MAN'X 520A	6 x 32	0.315 A	P03297509
MAN'X 520A	6 x 32	16 A	P03297505
MAN'X TOP	6 x 32	0.315 A	P03297509
MAN'X TOP	6 x 32	16 A	P03297505
MAN'X TOP PLUS	6 x 32	0.315 A	P03297509
MAN'X TOP PLUS	6 x 32	16 A	P03297505
Tellurohm CA 2	6 x 32	0.1 A	P01297012

ANALOGUE TESTERS 1 MULTIMETERS	160
ON-SITE MULTIMETERS	164
DIGITAL MULTIMETERS	170
POCKET CLAMP MULTIMETERS	174
ON-SITE ELECTRICAL SAFETY TESTER	178
BENCHTOP OSCILLOSCOPES	181

PORTABLE DIGITAL OSCILLOSCOPES	187
SPECTRUM ANALYSER	198
GENERATORS	200
POWER SUPPLIES	206
MULTIFUNCTION CALIBRATORS	208
TRAINING CASES AND SHUNTS	210
ACCESSORIES FOR OSCILLOSCOPES	211

TECHNOLOGICAL BREAKTHROUGHS AND PATENTED DISCOVERIES

A French brand known nationwide by generations of electricians and electronic engineers, Metrix® is Chauvin Arnoux's flagship brand in electronics for multimeters, oscilloscopes, power supplies and generators.

The Engineering Department and R&D teams are still based on the site at Annecy-le-Vieux, but they can now take full advantage of the high-performance industrialization tools on the Group's production sites in Normandy.

A little history...

PRODUCTS

METRIX: FROM THE LAMP METER, THE ELECTRO-CLAMP AND OSCILLOSCOPES TO ... THE MULTIMETER

1936 saw the founding of a small company named CARTEX. This company enjoyed considerable growth during the years of economic expansion following the Second World War.

Its main business was manufacturing portable "lampmeters" for checking the valves used in the radioelectricity sector, which was growing fast at the time. With the rising demand for electrical and electronic measurement equipment, CARTEX quickly became a major player in this sector, with products such as the lampmeter, testers and frequency generators. In 1946, it changed its name to "Compagnie Générale de Métrologie" (General Metrology Company) and began marketing its products under the Metrix brand.

The launch of the "electro-clamp", allowing users to check voltages without disconnecting and measure high currents

with one hand, and the production of oscilloscopes from 1948 onwards helped to quickly expand the company's offering. However, the products that really made the brand's reputation were the MX 460, launched in 1950, and more particularly, the MX 462 multimeter, which was so successful that it helped the company to grow very quickly



1950: launch of the MX 460...



...and the MX 400 electro-clamp



ASYC IV 100-kc-count colour graphical multimeter

HEALTHY RIVALRY

COMPANIES

Based in Annecy, the company continued to expand, boosting the local economy, but Metrix's success and expertise in the measurement field quickly drew the attention of large industrial companies and, in 1964, ITT International (International Telegraph and Telephone) took over the company and incorporated it into its instrumentation division to develop analogue and digital multimeters.

With the development of the instrumentation market, the spread of information technology offering new possibilities, the increasingly international competition and the changes in the technological and standardization requirements, Metrix joined the Chauvin Arnoux Group in 1997.

This was followed by several years of good-natured competition between Chauvin Arnoux's teams and the Metrix R&D Department. In this catalogue, you will find all the Chauvin Arnoux Group's products under the Metrix brand.



CHAUVIN ARNOUX IS AN INDUSTRIAL GROUP WITH A COMPREHENSIVE OFFERING FOR THE MEASUREMENT SECTOR

Three French companies, **Chauvin Arnoux**, **Pyrocontrole** and **CA Energy**, offer expertise in portable instrumentation, thermal processes, and electrical equipment and energy efficiency solutions, respectively.

90 % of the products are designed and manufactured entirely in one of Group's six **Research and Development centres**. Chauvin Arnoux benefits from production sites mainly based in Normandy, France. Every year, it proposes a palette of more than **5,000 product references** to meet the needs of contractors, government authorities and major customers in industry.

INTEGRATED SERVICE!

Alongside this extensive, comprehensive offering, 12 agencies under the Manumasure brand provide high-quality, nationwide metrology and regulatory testing services (repairs, metrological verification, pollution measurement, etc.). This expertise is also provided internationally via the ten local subsidiaries.



DESIGN AND PRODUCTION IN-HOUSE

Every year, the Group invests nearly 10 % of its sales revenues in Research and Development to maintain its technological leadership and its reputation for design and constant innovation. Designed in its R&D centres in France, Austria and the USA, the Group's measuring instruments are manufactured in Chauvin Arnoux's factories. The plastic and metal mechanical parts are made in Vire while the printed circuits are etched in Villedieu. Assembly, conditioning, storage and shipment worldwide are all handled on the Reux (Pont-l'Évêque) site in Normandy.

INTERNATIONAL PRESENCE

10 subsidiaries in Europe, the USA, China and the Middle East, backed by export sales teams, support the Chauvin Arnoux Group's international development and promote its Chauvin Arnoux, Metrix, Multimatrix, CA Energy, Pyrocontrole, AEMC and AMRA brands on all five continents.

ECO-DESIGN

For several years now, the Group has been implementing an ecologically-responsible approach intended to reconcile protection of the environment and the economic imperatives. The Chauvin Arnoux Group's EcoConception (eco-design) label highlights the company's commitment to recycling and recovery of products from the design phase onwards.



EDUCATION

FROM MIDDLE SCHOOLS... TO HIGHER EDUCATION

When studying Science and Technology, measurement is essential for assessing and understanding the theoretical phenomena through practical experiments. In both initial and higher education, it is important to determine the characteristics of a component or system, its behaviour in its environment and its evolution over time, using our measuring instruments.

Our offering covers everything from easy-to-use instruments for initial training through to the more complex tools encountered by students when they start their working life.

➔ See examples in the magazine "Les Cahiers de l'Instrumentation" (in French) which deals with measurement in all its forms: news, practical exercises for high schools, reports, etc.



INITIAL TRAINING & ELECTRONICS

In middle schools, one of the first tasks for students involves measuring the electrical quantities and then viewing the waveform of a signal.

Multimeters or oscilloscopes with a multimeter function are ideal for this initial familiarization and identification of the fundamental characteristics: amplitude, frequency, etc.

➔ View the case studies available on our website: <https://www.chauvin-arnoux.com/fr/notes-dapplication>



ELECTRICAL ENGINEERING CLASSES

In these classes, the subjects examined include converters, motors, generators and transformers. This training includes a large number of measurement operations characterized by the presence of significantly higher voltages and currents. Understanding and mastering electrical safety are crucial themes.

From Voltage Absence testing with a voltage detector through to the multimeters and clamp multimeters used for TRMS measurements (AC/ DC/ AC+DC), the measuring instruments used for recurrent measurements are equipped with functions ranging from the simplest (resistance, continuity, capacitance, etc.) to the most complex (differential and relative measurements, etc.).

➔ Professional training. As a certified training organization since 1993, CHAUVIN ARNOUX proposes specific training courses. <http://www.group.chauvin-arnoux.com/en/formations>



The Chauvin Arnoux Group is certified ISO 9001 and ISO 14001 on all its sites.

VISIT OUR WEBSITE
WWW.CHAUVIN-ARNOUX.COM

CHOOSE YOUR TESTER OR ANALOGUE MULTIMETER



TYPES	SMD TESTER	VOLTAGE TESTER	ANALOGUE MULTIMETERS	FIELD TESTERS	
QUICK SELECTION	TCX 01	TX 01	MX 1	VX 0003	VX 0100
Specifications					
Voltage measurement		AC and DC	AC and DC		
Resistance measurement	•	•	•		
Capacitance measurement	•				
Diode test	•		•		
Continuity test	•	•	•		
Phase identification		•			
Current measurement			AC and DC		
Current measurement with clamp					
LF electric field measurement (V/m)				10 Hz - 3 kHz	10 Hz - 100 kHz
LED – Analogue display		•	•	•	
Digital display	•				•
Power supply: battery / type	2 x 1.5 V / LR44	1 x 9 V / 6F22	1 x 1.5 V / LR6	1 x 9 V / 6F22	
Pages	162	161	161	162	

TX 01



An essential tool for electrical testing and diagnostics.

STRENGTHS

- AC and DC voltage testing
- Electrical continuity testing with audible and visual indication
- Phase identification
- Autotest function to check the status of the instrument and the battery
- Extra-bright LEDs
- Removable test probe with standard Ø4 mm banana connection
- Built-in system for stowing the lead

SPECIFICATIONS

	TX 01
Voltage test	12 V to 690 V (7 diodes)
Audible alarm	U > 50 V
Phase identification	Flashing "Ph" diode for U > 100 V
Operating frequency	DC ... 400 Hz
Diode polarity test	"+" and "-"
Audible continuity	Yes
Resistance	2 kΩ to 300 kΩ (3 diodes)
Power supply	1 x 9 V 6F22
Electrical safety	600 V CAT III
Dimensions / weight	193 x 47 x 36 mm / 170 g
Other	Built-in 1.2 m lead with Ø2 mm test probe + Ø2 mm removable test probe

CONTENTS

TX0001-Z : delivered with a removable test probe, a 9 V battery and a user's manual

MX1



With its needle and dial display, the MX 1 is easy to read and quickly displays the measurement results.



STRENGTHS

- IP65 shockproof and leakproof casing
- Audible continuity
- Protection of the ohmmeter function by an audible alarm
- Parallax mirror for precise measurements
- Faulty fuse indicator

SPECIFICATIONS

	MX1
Display	Analogue with parallax mirror / Scale length 80 mm
DC voltage	10 mV to 600 V
Calibres	150 mV / 0.5 V / 1.5 V / 5 V / 15 V / 50 V / 150 V / 500 V / 1.5 kV(1)
Accuracy class	2
AC voltage	10 mV to 600 V
Calibres	5 V / 15 V / 50 V / 150 V / 500 V / 1.5 kV(1)
Accuracy class	2.5
DC current	2 µA to 10 A
Calibres	50 µA / 500 µA / 5 mA / 150 mA / 500 mA / 1.5 A / 10 A
Accuracy class	2
AC current	20 µA to 10 A
Calibres	50 µA / 500 µA / 5 mA / 150 mA / 500 mA / 1.5 A / 10 A
Accuracy class	2.5
Resistance	Audible alarm if voltage present
Calibres	x 1 / x 10 / x 100
Middle point	200 Ω / 2 kΩ / 20 kΩ
Accuracy class	2.5
Audible continuity	< 150 Ω
Other measurements	
Diode test	Yes
dB	Yes
Ingress protection	IP 65
Power supply	1 x 1.5 V AA / LR6
Electrical safety	600 V CAT III as per IEC / EN 61010-1 Edition 2
Dimensions / weight	40 x 98 x 150 mm / 420 g

(1) Use limited to 600 Vmax



	MINI 01	MN 09
Clamping diameter	10 mm	20 mm
Measurement range	2 A to 150 A _{ac}	0.5 A to 200 A _{ac}
Transformation ratio	1,000/1	1,000/1

CONTENTS

MX 1 with 1 set of measurement leads with test probes, 1 x 1.5 V battery and user's manual in 5 languages.

TO ORDER

1 MX 1	MX1
1 MX 1 delivered with TX1 voltage tester and a carrying case	MX0001-T
1 MINI01 current clamp	P01105101Z
1 MN09 current clamp	P01120402

ACCESSORIES

See pages 211

TCX 01



Ergonomic, simple and quick for instant SMD identification.

STRENGTHS

- Automatic recognition of the SMD
- Wide dynamic range for measurement (6,000 counts for accurate testing of the highest and lowest values)
- Immediate implementation
- Test probes protected by a rigid cap

SPECIFICATIONS

		TX 01		
Display	6,000 counts			
Range selection	Automatic or Manual			
Resistance	Range	Resolution	Accuracy	
	600 Ω	0,1 Ω	±(1.2 % of reading + 2 digits)	
	6 kΩ	1 Ω		
	60 kΩ	10 Ω		
	600 kΩ	100 Ω		
	6 MΩ	1 kΩ		
60 MΩ	10 kΩ			
Capacitance	6 nF	1 pF	±(5.0 % of reading + 5 digits)	
	60 nF	10 pF	±(3.0 % of reading + 3 digits)	
	600 nF	100 pF		
	6 μF	1 nF		
	60 μF	10 nF	±(5.0 % of reading + 5 digits)	
	600 μF	100 nF		
6 mF	1 μF			
60 mF	10 μF	-		
Diode and semiconductor junction test	2 V	$I_{test} : \sim 1 \text{ mA} / V_{test} : \sim 2.8 \text{ V}$		
Continuity test	R < 30 Ω			
Automatic power-off	10 min			
Power supply	2 x 1.5 V AG13 / LR44 / 357A			
Dimensions / weight	181 x 35 x 20 mm / 65 g			

CONTENTS

TCX001-Z : 1 TCX delivered with soft case for storage, 2 x 1.5 V button cells and operating manual

ACCESSORIES

Set of 2 x 1.5 V LR44 batteries

P01296036

VX 0003 & VX 0100



The VX 0003 and VX 0100 BioTest field testers/meters instantaneously indicate the level of the low-frequency electric field. Ideal for the residential and tertiary sectors, they can be used by both professionals and DIY enthusiasts.

Measure your exposure to electromagnetic pollution in your home or office.

The VX 0003 and VX 0100 testers are easy-to-use, economical and trustworthy! They are used mainly when testing new or renovated electrical installations and in technical and vocational training.

STRENGTHS

- Test of the pollution generated by electrical power distribution (0-3 kHz) (VX 0003/VX 0100)
- Test of the pollution generated by the equipment connected (3-100 kHz) (VX 0100)
- 2 complementary methods for more effective measurements
 - Representative method: field measurement while taking the individual's presence into account
 - Traditional method: fields referenced to earth
- External antenna for field measurement and cable detection (VX 0100)
- Audible alarm for immediate identification of the field levels
- Testing in accordance with the current and future standards and directives



CONTENTS

VX0003 delivered in blister pack with a bag, earth cable, socket tester and 9 V battery

VX0100 delivered in a hard case with a bag, earth cable, socket tester and 9 V battery



ACCESSORIES

Bag for VX testers HX0104 Continuity rod P01102084A



SPECIFICATIONS

	VX 0003	VX 0100
Display & Buzzer		
Display on 2 scales of 7 LEDs each	•	
2,000-count backlit LCD display		•
Direct display in Volt/m (compatible with standards)	•	•
Buzzer proportional to E field level	•	•
Indication of measurement frequency range		•
"Low battery" & "Hold" indicators	•	•
Commands		
On / Off (with automatic shutdown after 30 min)	•	•
Measurement Hold	•	•
Buzzer On/Off	•	•
Measurement range selection	Manual	Automatic
3 kHz filter selection (<, >, full band)		•
Antenna & Reference		
Built-in "Field" antenna	•	
Removable "Field" antenna, diameter 62 mm + "cable detection" function		• •
"Individual" field measurement reference + continuity rod	•	• Optional accessory
"Earth" field measurement reference	•	•
Measurements		
RMS electric field intensity in V/m	•	•
Sensitivity & Accuracy		
2 sensitivity ranges (compatible with standards)	5 to 100 V/m - 100 to 2,000 V/m	1.0 to 200.0 V/m - 200 to 2,000 V/m
Measurement accuracy (in laboratory conditions)	±10 % on LED thresholds	±3 % ± 20 D @ 50/60 Hz
Frequency range		
Analysis of electrical equipment 10 Hz to 3 kHz	•	•
Analysis of equipment connected to the mains	10 Hz to 3 kHz	10 Hz to 3 kHz (3 kHz low-pass filter) 3 kHz to 100 kHz (3 kHz high-pass filter) 10 Hz to 100 kHz (no 3 kHz filter)
General specifications		
Power supply	1 x 9 V battery (supplied) - Battery life 60 to 80 hours - Automatic power-off function (30 min)	
Mechanical specifications	IP65 watertight casing- Dimensions 63.6 x 163 x 40 mm – Weight approx. 200 g with battery	
Warranty	2 years	

ACCESSORIES

For VX 0100	
Continuity rod	P01102084A
Continuity rod adapter	P01102034
Bag	HX0104
For VX 0003	
Hard case	HX0009

THE STANDARDS

- WHO / ICNIRP recommendations (World Health Organization / International Commission on Non-Ionizing Radiation Protection)
- IEEE C95.6-2002 (international standard - Public, 0-3 kHz range)
- European Directive 1999/519/CE (Public, 0-100 kHz range and beyond)
- European Directive 2004/40/CE (Workers, 0-100 kHz range and beyond)
- 2010 draft standard, EN IEC 62493 (lighting systems)
- EN50366 standard and IEC 62233 in 2012 (domestic electrical equipment)



**Digital for
"difficult environments"**

Industry



Quick selection	MTX 3290 MTX 3291
Technology	Digital
Display resolution (counts)	6,000 or 60,000*
TRMS / AVG measurement	TRMS AC & AC+DC
Simultaneous display(s)	2
Fast bargraph	•
Graph of measurements over time	
Backlighting / Automatic power-off	•*/•
DC basic accuracy	0.08 %*
Bandwidth	20 kHz // 100 kHz*
Auto / Manual ranges	•/•
AutoPeak for Crest Factor	•
Ingress protection	IP67
Available measurements	
AC/DC voltage	1,000 V* or 600 V
AC/DC current	20 A (30 s)
Single A terminal / Simultaneous U & I	•/•
Resistance / audible continuity / diode test	60 MΩ /•/•
Frequency / period / duty cycle	600 kHz /•/•
Pulse width / pulse count	•/•
Capacitance	60 mF
Temperature Pt100-Pt1000 / J-K thermocouple	•/-
dBm / resistive power	•/•
U & I peak / Crest Factor	250 μs /•
Filter for digital variable speed drives	300 Hz
Direct measurements with clamp	Ratio V/A
Low impedance AC voltage measurement	300 kΩ
Measurement processing	
Hold / Auto-Hold display functions	•/•
Min / Max / Avg monitoring	•/•/•*
Relative measurements / dB ratio / %	•/•/•
Storage capacity + measurement graphs	-
Time/date-stamping (SURV & MEM)	Relative Surv
RS232 / USB / Bluetooth interface	/•/-*
Safety & reliability	
EN61010 CAT IV / III	600 / 1,000 *
Electronic switch	•
Protected access to battery/fuses	•/•
"Closed casing" software calibration	
Catalogue page	168-169



"General-purpose" digital			"Benchtop" digital
Electrical			Laboratory
MTX 202	MTX 203	MTX 204	MX 5006 MX 5060
	Digital		Digital
4,000		6,000	6,000 or 60,000
	TRMS AC	TRMS AC+DC	TRMS AC & AC+DC
	1		2
	-		•
	•/-		•/•
	0.5 % or 0.2 %		0.05 %
	1 kHz		20 kHz to 100 kHz
	•/•		•/•
			•
	IP54		
	750 V / 1,000 V		1,000 V or 600 V
	10 A		20 A (30 s)
	-		•/•
40 MΩ /•/•		60 MΩ /•/•	60 MΩ /•/•
		1 kHz /•/•	600 kHz /•/•
No			
	100 mF		60 mF
-/•	-/•	-/-	-/•
	-/-		-/•
	-/-		250 μs /•
	-		300 Hz
	-		
	500 kΩ		300 kΩ
	•/-		•/•
		•/•/-	•/•/•
		•/-/-	•/•/•
	-		-
	-		Relative Surv
	-		/•/-
	- / 600		600 / 1,000
	-		•
	-		•/•
	166-167		170

* MTX 3291

MTX 202, MTX 203 & MTX 204



A range of 2 simple, basic TRMS AC multimeters with digital display for measuring on electrical networks and installations up to 600 V CAT III. These multimeters are general-purpose professional measuring instruments. They are the best tools for day-to-day use requiring the TRMS measurements, accuracy, rugged design and reliability of an on-site instrument.

★ STRENGTHS

- Automatic TRMS AC measurements on all the calibres for most of the customary electrical signals:
 - AC/DC voltage;
 - VLowZ low-impedance voltage;
 - temperature in °C and °F via K thermocouple (MTX202 & MTX203);
 - resistance and audible continuity, diode threshold voltage test;
 - capacitance measurement and AC/DC current measurement from 1 µA to 10A (depending on model) plus manual RANGE
- No-contact voltage (NCV) indication, useful for detecting live cables at 230 V
- A compact casing with a multipurpose sheath which fits in one hand: stowing of the leads, magnetized for mounting on metal cabinets and shockproof protection with the MULTIFIX system
- Blue backlighting with torch for optimized display in dark environments
- Automatic power-off after 30 minutes without activity which can be inhibited (permanent mode) to optimize the 500-hour battery life and the lifespan of the batteries
- Easy access to the 2 x 1.5 V batteries and fuse(s) by loosening 2 screws on the rear
- Compliant with the latest IEC61010-2-033 – 600 V CAT III safety standards
- The TRMS AC/AC+DC MTX 204 measures distorted signals stably and accurately and identifies faults. The frequency and the duty cycle are measured. This model is also equipped with Min/Max and Rel functions.



📦 CONTENTS

- 1 multimeter with batteries and fuses installed, 1 elastomer sheath with stand (MTX204 only), 1 set of 2 safety leads,
- 1 wire K thermocouple (MTX202 & 203 only), user's manual.

🛒 TO ORDER

MTX202 delivered in blister pack	MTX202-Z
MTX203 delivered in blister pack	MTX203-Z
MTX204 delivered in blister pack	MTX204-Z

⚙️ ACCESSORIES

See pages 211



SPECIFICATIONS

	MTX 202	MTX 203	MTX 204
Quick selection			
Display resolution	4,000 counts		6,000 counts
Auto power-off		30 min / Permanent mode	
Basic accuracy(Vdc)		0.2 %	
Bandwidth		1 kHz	
Available measurements			
Measurement range	10mV to 750 V _{AC} / 1,000 V _{DC}		
AC/DC voltage (ranges)	400 mV to 600 V / 600 V		600 mV to 750 V / 1,000 V
AC/DC current (ranges)	20 mA to 10 A		10 μ A to 10 A
Resistance (ranges)	1 Ω to 40 M Ω		1 Ω to 60 M Ω
Audible continuity		Yes	
Frequency and duty cycle			2 Hz to 1 kHz
Diode test		Yes	
Capacitance (ranges)		1 nF to 100 mF	
NCV		230 V / 50 Hz	
Temperature	-55 $^{\circ}$ C to 1,200 $^{\circ}$ C		No
Measurement processing			
Other measurements	Mode HOLD		HOLD, Min/MAX, Δ REL
General specifications			
Power supply / Battery life		2 x 1.5 V batteries / 500 h	
Dimensions / weight		170 x 80 x 50 mm / 320 g	
Safety and reliability			
Electrical safety	EN61010-02-33 - 600 V CAT III		
High-resistance casing		IP 54	
Warranty	2 years		



Bag: HX0052B



SHT 40kV probe: P01102097



K thermocouple: P01102107Z

MTX 3290 & MTX 3291



The multimeter designed for the field: a single, comprehensive, high-performance diagnostic instrument which nevertheless remains particularly easy to use!

★ STRENGTHS

- An innovative design with ergonomics suited to work in the field: fingertip function selection on the numeric keypad and comfortable grip, a large backlit LCD screen (3 positions) for viewing 2 simultaneous measurements (segments 14 mm high)
- Unrivalled user-friendliness:
 - "Virtual" one key / one function
 - Automatic V/A selection by cable positions and 8 backlit function keys
- Up to 2 x 60,000-count digital displays + bargraph: central zero, V_{OC} and I_{OC}
- 3 connection terminals, so a single fuse from 1 μA to 10 A
- Reminder of the measurement connections for each function
- Extra-versatile: V, A, Ohms, Hz, diode, capacitance, dB, °C, etc.
- Low-impedance measurement, time/date-stamped MIN, MAX and AVG monitoring, etc.
- CLAMP function for direct measurement of the current by integrating the transformation ratio: 1/1, 1/10, 1/100 and 1/1,000 mV/A
- Secondary measurements for electronics: DBm, resistive power, counting, pulse width, gain measurement, resistive power
- Communication for MTX 3291: isolated USB; "real-time" data transfer onto PC, drivers and SCPI commands

MULTIMETERS THAT GIVE YOU FINGERTIP CONTROL

Unique on the market, the electronic switch replaces the traditional mechanical switch, which is the major source of faults on handheld multimeters, while also improving performance and safety. At the same time, the possibility of direct access using the keypad avoids the intermediate positions typical of mechanical switches.

Each main measurement is instantaneously accessible with one of the 6 dedicated keys, without having to choose between the 4 or 5 positions of a mechanical switch for a simple voltage or current measurement.

🔧 ACCESSORIES

Optical/USB cable - MTX328X and MTX329X	HX0056-Z
External NiMH battery charger - MTX328X and MTX329X	HX0053
60,000-count MTX329X transport kit	HX0052B

🛒 TO ORDER

DMM 6 kcts TRMS 20 kHz	MTX3290
DMM 60 kcts TRMS 100 kHz USB	MTX3291

📦 CONTENTS

Multimeter delivered with 4 x 1.5 V alkaline batteries, red straight/straight lead 1.5 m long, black straight/straight lead 1.5 m long, red CAT IV 1 kV test probe, black CAT IV 1 kV test probe, User's manual on CD and Quick Start Guide on paper, USB cable and remote programming manual for communicating version (MTX 3291 + SX-DMM software)



 SPECIFICATIONS

	MTX 3291*				MTX 3290		
Display	Double, 60,000 counts				Double, 60,000 counts, TRMS		
Bargraph	with Central Zero for V _{DC} and I _{DC}						
Measurement rate	5 measurements per second						
Ranges	60 mV*	600 mV	6 V	60 V	600 V	1,000 V*	
Resolution*	0.001 mV	0.01 mV	0.0001 V	0.001 V	0.01 V	0.1 V	
DC accuracy	0.05 %				0.3 %		
AC and AC+DC bandwidth	100 kHz				20 kHz		
AC and AC+DC basic accuracy	0.5 %				0.8 %		
V _{LowZ} AC	300 kΩ						
DC, AC and AC+DC current							
Ranges	600 μA	6 mA	60 mA	600 mA	6 A	10 A / 20 A (30 s max)	
Resolution*	0.01 μA	0.1 μA	0.001 mA	0.01 mA	0.1 mA	0.1 mA	
DC accuracy	0.08 %				1.2 %		
AC and AC+DC bandwidth	20 kHz				20 kHz		
AC and AC+DC accuracy	1 %				1.5 %		
Frequency							
Frequency ranges	60 Hz		600 Hz	6 kHz	60 kHz	600 kHz	
Resolution*	0.01 Hz		0.1 Hz	1 Hz	10 Hz	100 Hz	
Resistance and continuity							
Ranges	600 Ω	6 kΩ	60 kΩ	600 kΩ	6 MΩ	60 MΩ	
Resolution*	0.01 Ω	0.1 Ω	1 Ω	10 Ω	100 Ω	1 kΩ	
Basic accuracy	0.2 %				0.5 %		
Protection	Electronic protection						
Audible continuity detection	600 Ω SIGNAL < 30 Ω +/- 5 Ω < 5 V						
Diode test							
Voltage measurement	3 V resolution 1 mV						
Capacitance							
Ranges	6 nF	60 nF	600 nF	6 μF	60 μF	600 μF	
Resolution*	0.001 nF	0.01 nF	0.1 nF	0.001 μF	0.01 μF	0.1 μF	
Temperature with Pt100/1000							
Operating range	-200 °C to +800 °C						
Accuracy	0.1 %						
Other functions							
MAX / MIN / AVG or PEAK +/-	On all the main measured parameters						
ΔREL*	REL relative value + secondary display with measured reference value						
PWM filter*	300 Hz, 4th order low-pass filter for measurements on variable speed drives of asynchronous motors						
Clamp function with direct reading on V output	Integration of ratio: 1/1, 1/10, 1/100, 1/1,000 mV/A						
Secondary functions*	dBm and resistive power VA, duty cycle +/-, and pulse width						
Central zero	Selectable or automatic for V _{DC} and I _{DC}						
USB communication	With SX-DMM – SCPI commands				-		

GENERAL SPECIFICATIONS

Type of display	Transflective LCD with backlighting *, digit height 14 mm
PC interfaces	Optical USB socket –SX-DMM software
Power supply	4 AA batteries (or NiMH rechargeable batteries)
Safety / EMC	Safety as per IEC 61010-2-033 – 1000 V CAT III* / 600 V CAT IV – EMC as per EN61326-1
Environment	Storage -20 °C to +70 °C – Operation -10 °C to +50 °C
Mechanical specifications	Dimensions (L x D x H): 196 x 90 x 47.1 mm / weight: 570 g
Warranty	3 years

(*) MTX3291 only

MX 5006 & MX 5060



A tried and tested casing. Simple and effective.

★ STRENGTHS

- A compact, lightweight casing
- A particularly easy-to-read display with widened viewing angle and digits 16 mm high
- Current measurement with a single current terminal up to 10 A
- MX5060: USB communication and programming with the SCPI protocol

LIGHTWEIGHT AND COMPACT

Multidirectional handle for positioning as you wish.
A casing which is can be stacked on your lab bench to save space.
The mains lead can be wound round the "feet" for easy storage.

A DISPLAY (890 X 450 mm)

Optimized over the whole height of the casing to offer comfortable reading with 16 mm digits on the main display above a second simultaneous display.

The transfective LCD screen with backlighting provides a wider viewing angle making it visible whatever the conditions.

A double 60,000-count display plus an analogue view by means of a bargraph.

TOP PERFORMANCE

0.05 % accuracy and AC, DC or AC+DC TRMS measurements, as required, as well as AUTO or manual ranges to optimize your measurements

EXTENDED FUNCTIONS

Equipped with all the traditional functions (voltage, current, resistance, continuity, diode test), these multimeters also offer extended functions: measurement of capacitance, frequency, period and REL relative. Values expressed as values and in %.

Measurements in total safety for electrical engineering applications with 1,000 V CAT III protection: a vLowZ low input impedance mode for stable measurements by eliminating "stray" voltages plus a PWM filter selectable for your measurements on variable speed drives (asynchronous motors).

Monitoring of your measurements with MIN / MAX (100 ms) / PEAK (1 ms) recordings to capture any faults.

The 3 terminals limit handling errors with complete current autoranging from 50 μ to 20 A. The MX 5060 is equipped with a USB interface for remote programming and processing of the data by our SX-DMM software for multimeters.

A simple, precise mechanical switch for selecting the main quantity and a secondary function key marked in colour.

CONTENTS

1 MX: 1 mains power cable, 1 set of 2 measurement leads,
1 user's manual + USB cable and SX-DMM software for MX 5060

TO ORDER

6,000-count TRMS benchtop multimeter	MX5006
60,000-count USB TRMS benchtop multimeter	MX5060

SPECIFICATIONS

	MX 5006	MX 5060
Resolution	6,000 counts	60,000 counts
Display	Transfective LCD Backlighting Widened viewing angle	
DC, AC and AC+DC TRMS voltage		
Ranges	600 mV to 1,000 V	60 mV to 1,000 V
DC	0.09 %	0.05 %
Useful bandwidth	100 kHz	
DC, AC and AC+DC current		
Ranges	6,000 μ A to 10 A (20 A / 30 s)	
AC and AC+DC basic accuracy	1 %	
DC basic accuracy	0.80 %	
Frequency measurements		
Ranges	60 Hz to 60 kHz	
Other measurements	Period PWM filter	
Resistance and continuity		
Ranges	600 Ω to 60 M Ω	
basic accuracy	0.40 %	0.20 %
Audible continuity test	600 Ω range – threshold < 30 Ω	
Diode test	0 to 3 V	
Capacitance	6 nF to 60 mF	
Temperature with K thermocouple	-200 to +1,200 $^{\circ}$ C	
Communication	USB	
Other measurements	SURV (MIN/MAX) and Peak +/- / Δ REL	
Complementary functions	HOLD and AUTO 300 Hz filter	
IEC61010-1 safety	1,000 V CAT III	
Dimensions (H x L x D) / Masse	295 x 270 x 95 mm / 1.85 kg	
Warranty	3 years	

SX-DMM

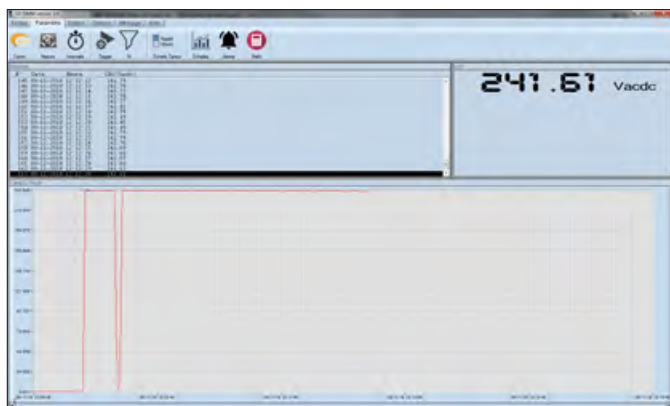

This data acquisition software can be used to link up to 4 controllable multimeters, whether they are on-site or benchtop models.

★ STRENGTHS

List of controllable multimeters

- MX26, M53, MX54, MX56, MX57, MX58, MX59
- MX554, MX556, MX5060
- MTX3250
- MTX3281, MTX3282, MTX3283
- MTX3291, MTX3292B, MTX3293B

This software can be used to communicate with our multimeters via an RS232, USB or BLUETOOTH link, depending on the model:



Choosing the type of DMM

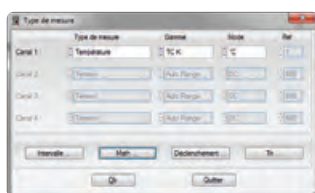

Type of measurement

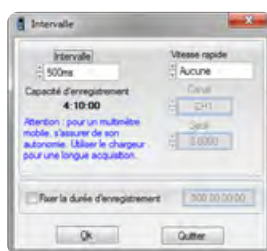

Acquisition, minimum interval 0.2 s on MTX 3292B / MTX 3293B



COMPLEMENTARY ANDROID APPLICATION FOR ASVC IV MULTIMETERS

- All the measurements on your Android mobile phone or tablet in real time.



TO ORDER

Software for multimeters

SX-DMM2

DATA DISPLAY

- Graphical trace
Each channel must be assigned to a COM or USB serial port for connection to be possible. Several SX-DMM sessions can be opened at the same time on a PC. The trigger mode and acquisition intervals can be set from 100 ms upwards and the clock can be managed automatically, depending on the model.
- Post-acquisition processing: sorting, simple or complex Math function on the channel, zoom, addition of cursors, XY functions, addition, subtraction, multiplication and division. This software transforms your multimeter into a power monitor with up to 4 channels for your one-off tests.
- The Math functions: XY, differential, integral, curve smoothing
- Data export into EXCEL for processing in a spreadsheet
- Screenshots



COMMUNICATION ACCESSORIES

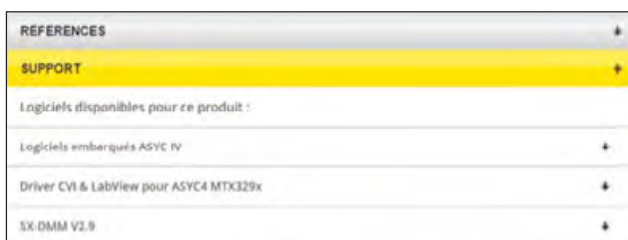

HX0056-Z, USB cable for MTX 328X and MTX 329X Series multimeters

	Description	References to order
MULTIMETERS		
MTX 3281, MTX 3282, MTX 3283, MTX 329X	MTX 328X calibration software Optical / USB cables Bluetooth USB modem	HX0059 HX0056-Z P01102112
MX 5060	USB A-USB B cable	P01295293
MTX 3292B, MTX 3293B	ASVC4 100K calibration software	HX0059B
MTX 3291, MX 5060	"Open-casing" calibration software	P01196770
All models	USB/RS232 adapter for PC	HX0055B

★ STRENGTHS

- The common software for all Metrix multimeters: SX-DMM2
- The LabView and LabWindows CVI instrument drivers and the USB drivers for our HX0055 and HX0056 accessories are available from the "Support" area on our website.



ADDITIONAL INFO

The remote programming guides describing the SCPI commands are delivered with the multimeters and are also available from the multimeter's Product Documentation area on our website.

CALIBRATION SOFTWARE



The various versions of this software help you to perform periodic testing and/or calibration of your instruments with the "casing closed" via their RS or USB serial communication interface (depending on the model), simply and effectively.

Without needing to research the technical details of the instrument, users can execute "manufacturer" procedures or develop their own procedures, in compliance with the Quality monitoring standards, while ensuring in particular the reverse traceability of their processes, saving their data and printing out reports.

LIST OF MULTIMETERS SUPPORTED WITH THE ASSOCIATED SOFTWARE

- MTX3292B and MTX3293B HX0059B

CALIBRATION KIT

- MTX3291, MX5060 P01196770
Calibration kit

The software can be used to generate adjustment and verification report files as well as a verification certificate.

List of adjustment points with possibility of memorization, including product traceability data

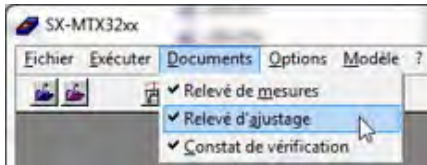

Step-by-step indications are provided for the connections and settings to ensure that the various adjustment phases are performed in the right order

The program is useful for checking the basic measurements and the verification results are available in a file.

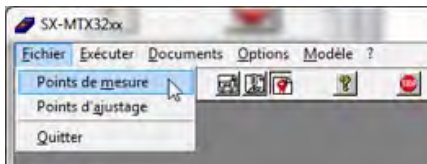
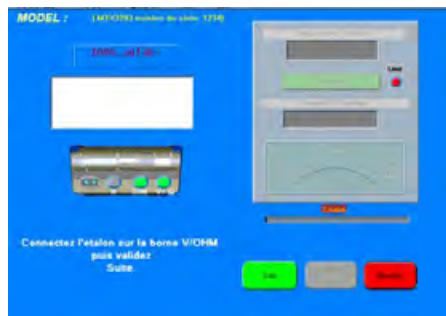

Example: extract from the file test.txt

Ranges	Setting	Max. dev.	Meas. dev.	Tolerance (%)
Offset V...	0.0000	not set		
100... mVdc	+ 90.000	not set		
100... mVdc	-90.000	not set		
1000...mVdc	+ 900.00	0.7202	-0.0300	4.16
1000...mVdc	- -900.00	0.7202	0.0000	0.00

Error (tolerance (%)) indicates the error on the general tolerance of the MTX. Here, the adjustment error is 4.16 % of the max. tolerance.

CLAMPS FOR DIGITAL MULTIMETERS

To measure a current > 10A, you are advised to use one of accessory clamps listed below with their measurement ranges.

To avoid powering down the circuit, you are advised to measure the current with a current clamp with A or V output. The direct measurement function is implemented on the ASYC multimeters (Ax function).

As the clamp function integrates a precise ratio xxxx.XA/xxxx.XV or XA, it is possible to connect a wide range of current clamps which you can find in the CHAUVIN ARNOUX Catalogue and on pages 96 to 101 of this document; however, you should check the input/output range of the clamp to ensure that it is compatible with the calibres offered by the multimeter.

The accuracy of this "clamp" function depends on the accuracy of the clamp and of the calibre or range used on the multimeter.



AC CURRENT	GENERAL USE						
	MINIO2	MINIO3	MINIO5	MINIO9	MN08/09	MN89	C106/C107
References	P01105102Z	P01105103Z	P01105105Z	P01105109Z	P01120401/02	P01120415	P01120304/05
Useful measurement range according to the multimeter (for use of 5 % to 100 % of the multimeter's ranges)							
MTX 202	1 A to 100 A	1 A to 100 A	500 mA to 100 A	1 A to 150 A	10 A to 240 A	0.5 A to 240 A	0.5 A to 1,200 A
MTX 203	200 mA to 100 A	1 A to 100 A	500 mA to 100 A	1 A to 150 A	1 A to 240 A	0.5 A to 240 A	0.5 A to 1,200 A
MTX 204	50 mA to 100 A	1 A to 100 A	5 mA to 100 A	1 A to 150 A	0.5 to 240 A	0.5 A to 240 A	0.5 A to 1,200 A
MTX 3290	200 mA to 100 A	1 A to 100 A	5 mA to 100 A	1 A to 150 A	0.5 to 240 A	0.5 A to 240 A	0.5 A to 1,200 A
MTX 3291	200 mA to 100 A	1 A to 100 A	5 mA to 100 A	1 A to 150 A	0.5 to 240 A	0.5 A to 240 A	0.5 A to 1,200 A
Clamp performance features							
Bande passante	10 kHz	500 Hz	500 Hz	500 Hz	10 kHz	10 kHz	10 kHz
Précision typique	1%	2%	3 % - 2 %	4%	1%	2%	0,50%
Diam. enserrage	10 mm	10 mm	10 mm	10 mm	20 mm	20 mm	52 mm
Output							
Connection	Lead	Lead	Lead	Lead	Sockets/Lead	Lead	Sockets/Lead

AC CURRENT	GENERAL USE		
	MINIFLEX MA110	MINIFLEX MA110	AMPFLEX A110
References	P01120660	P01120661	P01120630
Useful measurement range according to the multimeter (for use of 5 % to 100 % of the multimeter's ranges)			
MTX 202	1 A to 3,000 A	1 A to 3,000 A	1 A to 3,000 A
MTX 203	1 A to 3,000 A	1 A to 3,000 A	1 A to 3,000 A
MTX 204	1 A to 3,000 A	1 A to 3,000 A	1 A to 3,000 A
MTX 3290	0.08 to 3,000 A	0.08 to 3,000 A	0.08 to 3,000 A
MTX 3291	0.08 to 3,000 A	0.08 to 3,000 A	0.08 to 3,000 A
Clamp performance features			
Bandwidth	20 kHz	20 kHz	20 kHz
Typical accuracy	1%	1%	1%
Clamping diam.	45 mm	70 mm	140 mm
Output			
Connection	Lead	Lead	Lead



A110 (AmpFlex®)

MA110 (MiniFlex®)

On the ASYC IV MULTIMETERS, the CLAMP function integrates the transformation ratio in mV or mA/A according to the coupling selected. The measurement range of clamp will be adapted to match the measurement range of the multimeter. MTX3290 and MTX3291 fixed ratios: 1/1-1/10-1/100-1/1,000 mV/A

The clamps are also compatible with other multimeter models.

For example : - the clamps for the MTX 3290 are compatible with the MX 5006, - the clamps for the MTX 3291 are compatible with the MX 5060.



AC/DC CURRENT	GENERAL USE			LEAKAGE CURRENT	PROCESS	CURRENT TRANSFORMER
	E25	PAC16	PAC25	MN73	K2	MN71
References	P01120025	P01120116	P01120125	P01120421	P01120074A	P01120420
Useful measurement range according to the multimeter (for use of 5 % to 100 % of the multimeter's ranges)						
MTX 202	100 mA to 80 A	1 A to 600 A _{DC} 1 A to 400 A _{AC}	1 A to 1,400 A _{DC} 1 A to 1,000 A _{AC}	50 mA to 240 A	10 mA to 450 mA _{DC} 10 mA to 3.3 mA _{AC}	100 mA to 12 A
MTX 203	100 mA to 80 A	1 A to 600 A _{DC} 1 A to 400 A _{AC}	1 A to 1,400 A _{DC} 1 A to 1,000 A _{AC}	50 mA to 240 A	10 mA to 450 mA _{DC} 10 mA to 3.3 mA _{AC}	100 mA to 12 A
MTX 204	100 mA to 80 A	1 A to 600 A _{DC} 1 A to 400 A _{AC}	1 A to 1,400 A _{DC} 1 A to 1,000 A _{AC}	50 mA to 240 A	10 mA to 450 mA _{DC} 10 mA to 3.3 mA _{AC}	100 mA to 12 A
MTX 3290	5 mA to 80 A	500 mA to 600 A _{DC} 500 mA to 400 A _{AC}	500 mA to 1,400 A _{DC} 500 mA to 1,000 A _{AC}	50 mA to 240 A	5 mA to 450 mA _{DC} 5 mA to 3.3 mA _{AC}	60 mA to 12 A
MTX 3291	5 mA to 80 A	500 mA to 600 A _{DC} 500 mA to 400 A _{AC}	500 mA to 1,400 A _{DC} 500 mA to 1,000 A _{AC}	50 mA to 240 A	5 mA to 450 mA _{DC} 5 mA to 3.3 mA _{AC}	60 mA to 12 A
Clamp performance features						
Bandwidth	20 kHz	30 kHz	30 kHz	10 kHz	1,5 kHz	10 kHz
Typical accuracy	4 %	1.5% - 3 %	1.5% - 5 %	1 % - 2 %	1 %	1 %
Clamping diam.	11.8 mm	30 mm	39 mm	20 mm	3.9 mm	20 mm
Output						
Connection	Lead	Lead	Lead	Lead	Casing, 19 mm spacing	Lead



	MX 350	MX 355	MX 650	MX 655	MX 670	MX 675
AC current	•	•	•	•	•	•
DC current		•		•		•
RMS/TRMS measurement	•	•		•	•	•
Clamping diam. 26 mm	•					
Clamping diam. 30 mm		•				
Clamping diam. 36 mm			•			
Clamping diam. 40 mm				•		•
Clamping diam. 42 mm					•	
4,000-count display			•	•		
6,000-count display	•	•				
10,000-count display					2	2
Backlighting					•	•
Bargraph			•	•		
AC current	400 A	400 A	1,000 A	1,000 A	1,000 A	1,000 A
DC current		400 A		1,000 A		1,400 A
AC voltage	600 V	600 V	750 V	750 V	1,000 V	1,000 V
DC voltage	600 V	600 V	1,000 V	1,000 V	1,400 V	1,400 V
Resistance	•	•	•	•	•	•
Audible continuity	•	•	•	•	•	•
Diode and semi-conductor tests			•	•		
Frequency	•		•	•	•	•
Temperature					•	•
Hold	•	•	•	•	•	•
Zero or REL		•	•	•		•
Min / Max / Peak		- / - / •	• / • / •	• / • / •	• / • / •	• / • / •
Ranges			•			
Automatic power-off	•	•	•	•	•	•
600 V CAT III	•	•	•	•		
1000 V CAT III					•	•
600 V CAT IV					•	•
Pages	175	175	176	176	177	177

MX 350 & MX 355



Comprehensive: all the functions needed by electricians in one hand.

★ STRENGTHS

- Compact, ergonomic clamp multimeters
- Current measurement up to 400 A_{AC} (MX 350) or 1,000 A_{AC} and 1,000 A_{AC&DC} (MX 355)
- AC & DC voltage measurement up to 600 V
- Resistance and continuity measurement
- Frequency measurement (MX 350)
- Automatic DC Zero (MX 355)
- TRMS measurements
- Peak function (1 ms) (MX 355)

⚙️ SPECIFICATIONS

	MX 350	MX 355
Designation	400A _{AC} TRMS clamp multimeter	400A _{AC/DC} TRMS clamp multimeter
Display	6,000 counts	
Bargraph	-	
Clamping diam.	26 mm	30 mm
Type of acquisition	TRMS	
Range selection	Automatic	
AC current	0.05 A to 400.0 A	
Basic accuracy	1.9 % of reading + 5 D	
Bandwidth	48 to 400 Hz	
DC current	-	0.1 A to 400.0 A
Basic accuracy	-	2.5 % of reading + 10 D
AC voltage	0.05 V to 600.0 V	
Basic accuracy	1.9 % of reading + 5 D	
Bandwidth	48 to 400 Hz	
DC voltage	0.03 V to 600.0 V	
Basic accuracy	1 % of reading + 3 D	
Resistance	0.2 Ω to 600.0 Ω	
Basic accuracy	1 % of reading + 2 D	
Audible continuity	≤ 40 Ω	
Frequency	For I: 20 Hz to 10.00 kHz For V: 10 Hz to 100.0 kHz	-
Functions	Hold	Hold ΔZero Peak (1 ms)
Automatic power-off	20 min., deactivatable	
Power supply	2 x 1,5 AAA / LR03	
Electrical safety	IEC 61010-1, IEC 61010-2-032 / 600V CAT III	
Dimensions / weight	199 x 75 x 36 mm / 243 g (with batteries)	

🛒 TO ORDER

1 MX 350 clamp	MX0350Z
1 MX 355 clamp	MX0355Z

⚙️ ACCESSORIES

See pages 211

📦 CONTENTS

1 MX 35x clamp multimeter delivered with 1 set of measurement leads with test probes, 1 soft case, 2 x 1.5 V AAA alkaline batteries and 1 user's manual in 5 languages.

MX 650 & MX 655

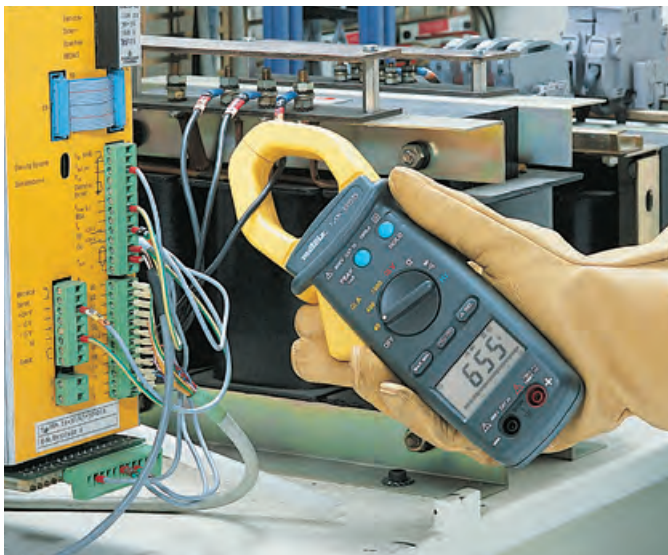

Ideal for maintenance of electrical or electrotechnical machines.

★ STRENGTHS

- Clamps for measuring high current and voltages
- Current measurement up to 1,000 A_{AC} (MX 650) and 1,000 A_{AC} and 1,000 A_{AC&DC} (MX 655)
- AC & DC voltage measurement up to 1,000 V
- Resistance, continuity and frequency measurements
- RMS measurements (MX 655)
- Min-Max et Peak 1 ms analysis functions
- Differential measurement of current, voltage and resistance

⚙️ SPECIFICATIONS

	MX 650	MX 655
Display	4,000 counts	
Bargraph	42 segments	
Clamping diameter	36 mm	40 mm
Type of acquisition	AVG	RMS
Range selection	Automatic or manual	Automatic
AC current	0.05 A to 1,000 A	
Basic accuracy	1.9 %R + 5 D	
Bandwidth	50 Hz to 1 kHz	
DC current	-	0.10 A to 1,000 A
Basic accuracy	-	2.5 %R + 10 D
AC voltage	0.5 V to 750 V	
Basic accuracy	2.5 %R + 10 D	
Bandwidth	50 Hz to 1 kHz	
DC voltage	0.2 V to 1,000 V	
Basic accuracy	0.75 %R + 2 D	1 %R + 2 D
Resistance	0.2 to 4,000 Ω	
Basic accuracy	1 %R + 2 D	
Audible continuity	≤ 100 Ω	
Diode and semi-conductor junction tests	I _{test} ≤ 0.6 mA / V _{test} ≤ 3.3 V _{DC}	I _{test} ≤ 1.7 mA / V _{test} ≤ 6 V _{DC}
Frequency	For current: 20 Hz to 10 kHz For voltage: 10 Hz to 10 kHz	
Basic accuracy	0.1 %R + 1 D	
Functions	Hold, Peak (1 ms), Max-Min, Hold, Peak (1 ms), Max-Min, ΔREL, Range	
Automatic power-off	30 min, deactivatable	
Power supply	1 x 9 V 6LF22	
Electrical safety	IEC 61010-1, IEC 61010-2-032, IEC 61010-2-033 - 600 V CAT III	
Dimensions / weight	246 x 93 x 43 mm / 400 g	

🛒 TO ORDER

1 MX 650	MX0650-Z
1 MX 655	MX0655-Z

⚙️ ACCESSORIES

See page 211

📦 CONTENTS

1 MX 65x clamp multimeter delivered with 1 set of measuring leads with test probes, 1 flexible carrying bag, 1 x 9 V alkaline battery and 1 user's manual in 5 languages

MX 670 & MX 675



Extra protection for industry and electrical power distribution.

★ STRENGTHS

- 2 simultaneous TRMS measurement channels
- Dual 10,000-count backlit display
- CAT IV 600 V
- Voltage up to 1,400 V
- Temperature measurement

⚙️ SPECIFICATIONS

	MX 670	MX 675
Clamping diam.	42 mm	40 mm
Display	2 x 10,000 counts / backlit	
Type of acquisition	TRMS AC/DC	
Range selection	Automatic	
AC current	0.05 A to 1,000 A	
Basic accuracy	1.5 % of reading + 5 D	
Bandwidth	50 Hz to 3 kHz	
DC current	-	0.10 A to 1 400 A
Basic accuracy	-	1.2 % of reading + 5 D
AC voltage	0.5 V to 1,000 V	
Basic accuracy	1 % of reading + 5 D	
Bandwidth	50 Hz to 3 kHz	
DC voltage	0.2 V to 1,400 V	
Basic accuracy	1 % of reading + 2 D	
Resistance	0.2 to 9999 Ω	
Basic accuracy	1 % of reading + 2 D	
Audible continuity	≤ 35 Ω	
Temperature	-40.0 °C to +1,200 °C / -40 °F to +2,192 °F	
Basic accuracy	1 % of reading + 2 °C / 1 % of reading + 4 °F	
Frequency	Current: 0.2 Hz to 9999 Hz Voltage: 10 Hz to 9999 Hz	
Basic accuracy	1 % of reading + 2 counts	
Functions	Hold Peak (1 ms) Min (500 ms) Max (500 ms)	Hold Peak (1 ms) Min (500 ms) Max (500 ms) ΔZero
Automatic power-off	10 min, deactivatable	
Power supply	1 x 9 V 6LF22	
Electrical safety	IEC 61010-1, IEC 61010-2-032, IEC 61010-2-033 600 V CAT IV / 1 000 V CAT III	
Dimensions / weight	272 x 80 x 43 mm / 480 g	257 x 80 x 43 mm / 440 g

📦 CONTENTS

- 1 MX 67x clamp multimeter delivered with 1 x 9 V alkaline battery,
- 1 user's manual in 5 languages, 1 soft case,
- 1 set of leads with Ø 4 mm test probes and K-thermocouple sensor

🛒 TO ORDER

1 MX 670	MX0670-Z
1 MX 675	MX0675-Z

⚙️ ACCESSORIES

See pages 69 to 78



MX 531

V

Ω

Rotating head



Practical, simple measuring instrument for TT neutral systems. MX5 "3 in 1":

1- Measures the voltage and displays the connection configuration

2- Automatic earth measurement

3- 30mA trip test by pressing the TEST button

★ STRENGTHS

- A simple, reliable and accurate earth tester with a maximum resolution of 0.1 Ω.
- A 30mA RCD tester
- Totally autonomous (no battery needed) with immediate display without adjustments or selection of a position
- A tester suitable for any socket configuration with its rotating head and compact size
- Use on 2P+E sockets with verification of the connection of the line, neutral and earth conductors.
- Instantaneous display on the two-colour LCD screen facilitating interpretation of the measures according to the conformity of the installation
- Measures the earth without tripping any RCDs : test current < 12 mA.
- A test button to trip the 30 mA_{AC} RCD with the display held for 7 s.

⚙️ SPECIFICATIONS

	MX531
Display	2,000 counts
Acquisition	RMS AC+DC
Autorange	Yes
RE error / earth fault	Red screen displayed if RE >100 Ω or OL >2,000 Ω
RE earth range	0 to 1,999 Ω
Autorange	0 to 199.9 Ω and 180 Ω to 1,999 Ω
Resolution	0.1, 1 Ω
Accuracy	± (3% of reading+5D)
Protection / admissible overload	300V CAT III
RMS voltage (AC+DC)	90 to 400 V
Line-neutral voltage	0 to 420 V 50/60 Hz - Indication of L/N reversal - If <195 V and >253 V: fault
Resolution	1 V
Accuracy	± (2%+1D)
Indication of position	Line, neutral and earth
RCD 30mA type AC	If RE correct
Rated value	230V between line and neutral, current 30mA -0%+6%
Conditions	Time 200ms ± 4ms
General specifications	
Display	Two-colour blue/red 46x50 mm backlit LCD
Type of socket	2P +E 10/16A -Types E and F
Safety	EN61010-2-030, pollution degree 2, CATIII-300V
Operating temperature	-10 to +45°C
Standards	Test as per IEC/EN 61557-1 -3 and -6 – EMC as per IEC61236-1 IEC61010-1 CAT III 300V
Dimensions/weight/IP/IK	Dimensions 185X65X53 mm Weight: 230g ± 50g / IP40/IK07

🛒 TO ORDER

EARTH RCD30MA

MX0531

📦 CONTENTS

MX0531 EARTH RCD30mA

Equipped with a wrist-strap, bag and user's manual on paper.

MX 406B



Analogue insulation tester

★ STRENGTHS

- Insulation measurement at 50, 250 and 500 V_{DC}
- Voltage measurement up to 440 V_{AC/DC}
- Continuity (200 mA)
- Quick and easy readings with the colour-scale dial
- Hands-free use with remote control probe



⚙️ SPECIFICATIONS

	MX 406B
Insulation	10 kΩ to 200 MΩ at 50 / 250 and 500 V _{DC} (3 ranges)
Continuity + audible beep	0 to 10 Ω (i > 200 mA _{DC})
Voltage	0 to 440 V _{AC/DC}
Electrical safety	IEC 61010 – 300 V CAT III
Power supply	3 x 1.5 V batteries for a battery life of 1,000 x 5 s measurements
Dimensions / weight	155 x 98 x 40 mm / 410 g

📦 CONTENTS

MX406B: 1 MX 406B tester delivered with 1 remote-control probe, 1 black safety lead, 1 black crocodile clip, 3 x 1.5 V batteries and 1 user's manual

🛒 TO ORDER

1 MX 406B tester

MX0406B

MX 604



Lightning arrester tester.

★ STRENGTHS

- Lightning-arrester support module for measurements on unmounted lightning arresters
- Probe with remote-control button for in-situ measurements
- Measures insulation resistance at 50, 100 and 500 V_{DC}
- Quick and easy readings with the colour-scale dial



⚙️ SPECIFICATIONS

	MX 604
Lightning arrester test	0 to 600 V _{DC}
Insulation	100 kΩ to 2 000 MΩ at 50 / 100 and 500 V _{DC} (3 ranges)
Battery test	Yes
Electrical safety	IEC 61010 – 300 V CAT III
Power supply	3 x 1.5 V batteries for a battery life of 1,500 x 5 s measurements
Dimensions / weight	155 x 98 x 40 mm / 350 g

📦 CONTENTS

- 1 MX 604 delivered in a hard case with 1 detachable lightning-arrester support module, 1 remote-control probe, 1 red test probe, 1 black straight-straight lead 1.5 m long with built-in test probe, 1 black crocodile clip, 1 lightning-arrester support clamp, 1 strap mounted on the instrument, 3 batteries, 1 user's manual in 5 languages



🛒 TO ORDER

1 MX 604 tester

MX0604

⚙️ ACCESSORIES

See page 211

INTRODUCTION

The first step for choosing an oscilloscope involves taking a bit of time to think about how and where you want to use it. Here are some of the typical questions which you need to answer:

- Where is the oscilloscope going to be used (in a lab, for education, in an electrical cabinet)?
- How many signals do you want to measure simultaneously? 2 or 4?
- What voltage ranges do you want to measure or record?
- What is the maximum frequency to be measured?
- Are the signals repetitive or unique?
- Do you need to view the signals in the frequency domain as well as in the time domain?

When these aspects have been clarified, you can start looking for the most suitable oscilloscope for your specific applications, but we are going to define the specifications to ensure the best choice.

Unlike with analogue oscilloscopes, the signal to be viewed is first digitized by an ADC (analogue-digital converter). The instrument's ability to display high-frequency signals without distortion depends on the quality of this interface.

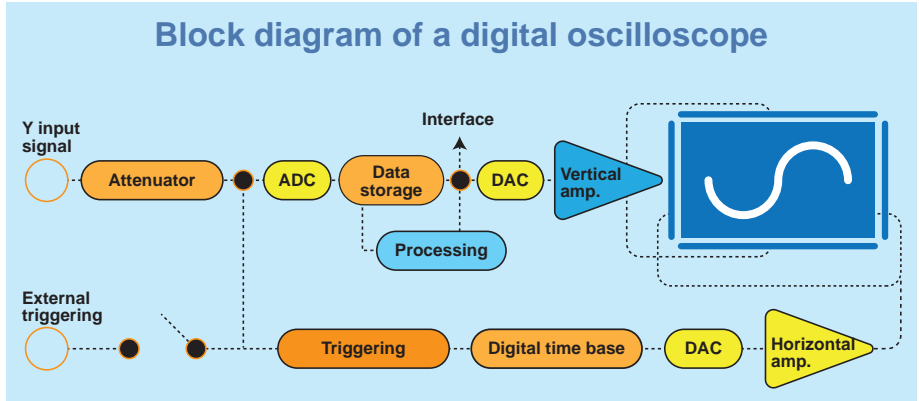

The DSO (Digital Storage Oscilloscope) samples and then plots the samples as a function of time; there are 2 families of digital oscilloscopes available:

- **benchtop oscilloscopes** or DSOs dedicated to use in electronics: compact, large bandwidth, on-screen measurements, large storage capacity, communication and printing;
- **portable oscilloscopes** dedicated to electrical use: battery life, number and type of channels, screen and analytical tools.

MAIN SPECIFICATIONS TO BE TAKEN INTO ACCOUNT:

• **The input ranges.** Our oscilloscopes offer several selectable input ranges from $\pm 1\text{mV}$ to $\pm 200\text{V/div}$ and our benchtop oscilloscopes have a common earth connection between channels and in relation to the earth, whereas our portable oscilloscopes propose channels which are isolated from one another and in relation to the earth up to 600 V.

An oscilloscope with isolated channels will ensure safety and measurement flexibility in all situations, from 1 mV to 600 V.

As high voltages may be measured using 10:1 and 100:1 attenuation probes or single/double differential probes, it is important to check that the oscilloscope is equipped with a sufficiently small voltage range for the signals that we want to measure. If you regularly have to measure weak signals (under 50 mV), you may have to look into buying an oscilloscope with 12-bit resolution.

Check that the oscilloscope probes or accessories that you plan to use are of an equivalent or higher level or category (cf. IEC61010) than the oscilloscope's bandwidth.

• **Bandwidth:** the first specification to consider. In fact, this is the maximum signal frequency which can pass through the input amplifiers. As a result, the analogue bandwidth of the oscilloscope must be higher than the maximum frequency that you want to measure (real time).

Most oscilloscope manufacturers define the bandwidth as the frequency at which the input signal is reduced to 71 % of its real amplitude (the -3 dB point). In other words, the permitted error is 29 %. We indicate the bandwidth of our oscilloscopes at -3 dB.

• **The resolution** of the analogue-digital converter (vertical resolution 8/9/10/12 bits): 1/256 or 0.4 % for an 8-bit ADC, while SCOPIX (depending on models) proposes a vertical resolution of 12 bits because it is high-resolution precision oscilloscope for audio, noise and vibration applications.

Dans l'électronique numérique, un changement In digital electronics, a 1% change in the signal is not usually a problem, but in audio electronics, a 0.1% distortion or noise may cause dysfunctions. Most modern DSOs are optimized to function with fast digital signals and only offer 8-bit resolution (8-bit analogue-digital converter). This means they can detect any signal change from 0.4 % upwards.

• **The sampling frequency** ... in MS/s (mega-samples per second) or GS/s (giga-samples per second) or real-time sampling mode or ETS equivalent-time mode:

According to Nyquist's theorem, the sampling rate must be equivalent to at least twice the maximum frequency that you want to measure: for

a spectrum analyser, this may be insufficient, but for an oscilloscope, you need at least 5 samples to accurately reconstitute the waveform.

Most oscilloscopes have two different sampling rates (modes) depending on the signal measured: real-time mode and ETS (Equivalent Time Sample) mode, also called repetitive sampling. ETS only functions if the signal measured is stable and repetitive, since this mode operates by building a waveform from successive acquisitions.

• **The memory depth**

DSOs record samples in a buffer memory so, for a given sampling rate, the size of the buffer memory determines the maximum acquisition duration before it becomes full.

The relation between the sampling rate and the memory capacity is important: an oscilloscope with a high sampling rate but a small memory capacity will only be able to use its maximum sampling rate on a few of the fastest time bases.

Our SCOPIX portable oscilloscope samples at 2.5 GS/s in real time with a memory capacity of 100 kpts. The benchtop DOX3304 model offers 2 GS/s with a memory capacity of 28 Mpts.

• **An oscilloscope can be used to view the waveforms and signal processing tools** are often useful: FFT, harmonic analysis or even recording functions which are integrated in our oscilloscopes.

Furthermore, the result is increasingly displayed on a TFT LCD screen, making these instruments easy to move and significantly less energy-hungry.

Our digital oscilloscopes are all equipped with a communication interface to extend the analysis (USB host or device, Ethernet or Wifi) and data processing software on PC or tablet.

PC software or Android applications are available for each oscilloscope.

The firmware is regularly upgraded. Keep up to date with our versions by using the firmware loader on our support website.

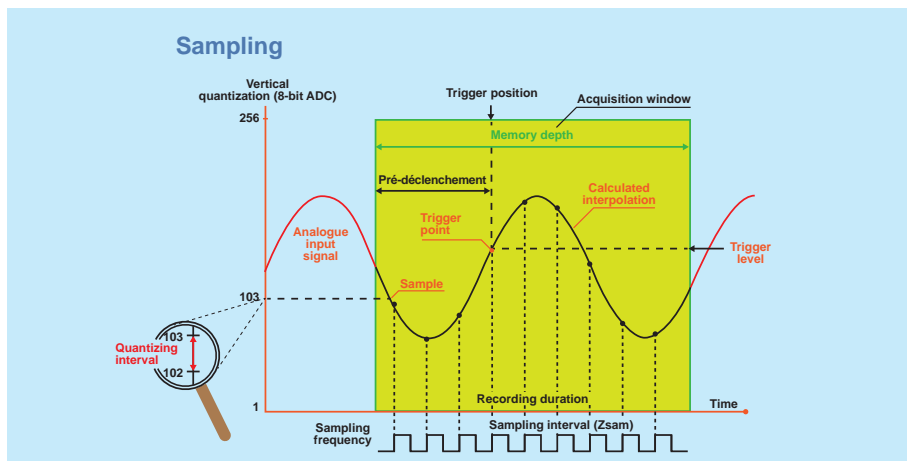

CHOOSE YOUR OSCILLOSCOPE



SELECTION FAMILIES	"ADVANCED" LAB	
	CLASSIC	ELECTRONICS EXPERT
	DOX2025B DOX2070B DOX2100B	DOX3104 DOX3304
Bandwidth	25 to 100 MHz	100 to 300 MHz
Channels (number/type)	2 / Class 1	4 / Class 1
IEC61010 safety	CAT II 300 V	CAT I 300 V
One-shot digital sampling	500 MS/s to 1 GS/s	1 GS/s
ETS repetitive mode	5 GS/s	-
Vertical resolution	8 bits	8 bits
Integrated modes	OX	OX+GX+DECODE
"Oscilloscope" specifications		
Max. input sensitivity	2 mV/div	2 mV/div
Max. input amplitude	10 V/div	10 V/div
Analogue filters	Digital filters	-
Time base (per division)	2.5 ns - 50 s	1 ns - 50 s/div
Memory depth	32 k/channel	-
Acquisition memory	Up to 2 MB	28 MB
No. of reference curves or math curves on screen	2	4
Envelope/Averaging modes	-/•	•/•
SPO (Smart Persistence Oscilloscope)	-	•
Automatic measurements/cursors	32/•	32
Pulse trigger on width/number	•/•	•/•
Video trigger (line counter)	•	•
Adjustable Hold-Off / Delay	•/•	•/•
Calculation functions + - / x / : / Advanced		•/•/•/FFT-
Other functions		
Lin & Log FFT spectral analysis	8 bits	8 bits
General specifications		
Colour LCD / B&W / Tube screen	7"/•/-	8"
Communication		USB and Ethernet
PC software / ANDROID app.		Easywave for PC
Pages	182	184

DOX2000B FAMILY



★ STRENGTHS

- 7" panoramic colour LCD screen, resolution 800 x 480 pixels
- Multiple communication interfaces
- High performance and numerous functions for acquisition and analysis

TOP-CLASS ERGONOMICS: EXTRA-BRIGHT 7" COLOUR TFT SCREEN, RESOLUTION 800 X 480 PIXELS

- Customization of the display to suit your needs: normal or persistent display, YT or XY format, screen types with adjustable colours, graticule, brightness, contrast, etc.
- Simple front panel: traditional front-panel controls (rotary knobs and keys)
- 5 language choices selectable per menu (English, French, Spanish, Italian, German)
- Quick power-up and power-down in less than 10 s
- Easy to transport due to its shape, its built-in handle and its 9-inch depth

HIGH PERFORMANCE AND MULTIPLE FUNCTIONS FOR ACQUISITION AND ANALYSIS

- Maximum sampling rate of up to 1 GS/s in one-shot mode and 50 GS/s for periodic signals
- Acquisition memory depth from 32 kpoints to 2 Mpoints, depending on the model, to optimize your analyses
- 5 complete trigger types: edge, pulse, video, slope and alternate
- 32 simultaneous automatic measurements on screen and manual cursor measurements
- Recording of up to 7 Mpoints by slow acquisition

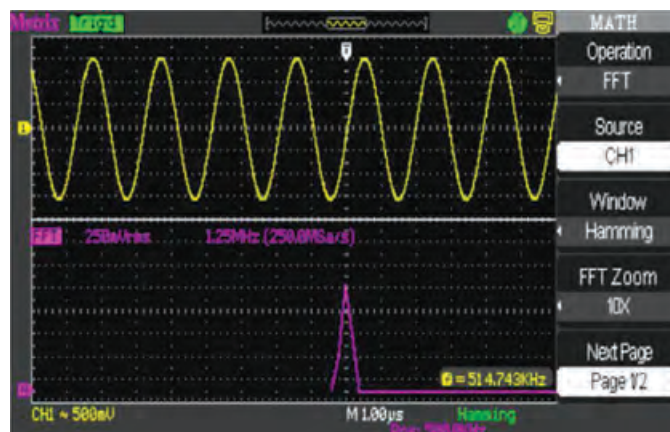

Simple MATH functions +/-'/' and "real-time" FFT function with simultaneous display of trace

PRACTICAL INTERFACES AND PRINTING

- Usual communication: USB host and device (PC, USB key)
- Multiple storage: 20 configurations and 5 types of recordings: parameters, curves, images, .csv and factory settings internally or on USB key, etc.
- Comprehensive EASYSCOPE software for all your analyses

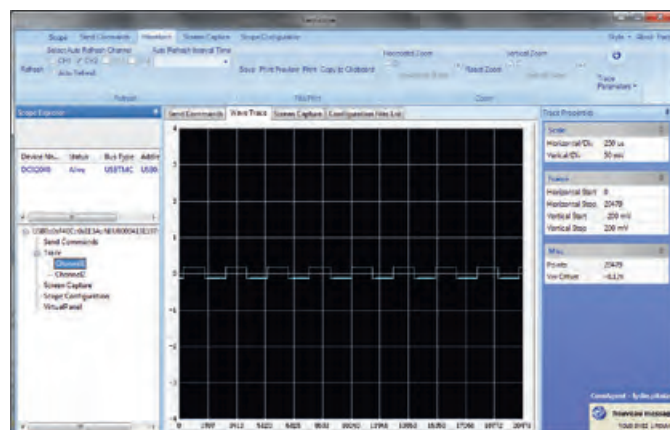

Easyscope software for data processing (csv), transmission of SCPI commands, screenshots (bmp), configuration, virtual panel.

 SPECIFICATIONS

	DOX 2025B	DOX 2070B / DOX 2100B
Human-machine interface		
Type of display	7" colour TFT LCD screen (resolution 800x480 px) / Brightness and contrast adjustment	
Display of curves on screen	8 x 16 divisions trace area / 2 curves + reference + Math function – Complete graticule or borders Display mode: Samples or Vectors with interpolation or Persistence Mode	
Commands	Usual direct commands via buttons on front panel / System with menus on right-hand side of screen with selection using 5 buttons opposite – "Menus On/Off" and print commands	
Choice of language	By menu, 5 languages (FR/EN/DE/IT/ES), online help in English	
Vertical deflection		
Bandwidth	25 MHz	0 MHz / 100 MHz 20 MHz bandwidth limiter
Number of channels	2 channels, common chassis-earths	
Impedance	1 MΩ / 18 pF and External Trig channel	
Display of traces	Channel number, earth reference indicator and trace in the colour of the channel	
Maximum input voltage	±300 Vp-p (without probe)	
Vertical sensitivity	12 calibres from 2 mV to 10 V/div - Basic accuracy ±3 %	
Rise time	< 7 ns	< 5 ns (DOX 2070B) < 3.5 ns (DOX 2100B)
Compensated probe factors	x 0.1 / 0.2 / 1 / 5 / 10 / 50 / 100 / 500 / 1,000 / 2,000 / 5,000 / 10,000	
Horizontal deflection		
Sweep speed	5 ns/div. to 50 s/div. (Oscilloscope mode)	2.5 ns/div. to 50 s/div. (Oscilloscope mode)
Scan or ROLL mode	100 ms/div. to 50 s/div. (Recorder – Scan mode)	
Horizontal zoom	Yes	
Triggering		
Sources / Modes	CH1, CH2, Ext, Ext/5, mains / automatic, triggered, one-shot - XY	
Roll mode	100 ms/div. to 50 s/div.	
Type	Edge, pulse width (20 ns-10 s), video (Pal, Secam, NTSC), slope, alternate, HOLD OFF from 10 ns to 1.5 s	
Coupling	AC, DC, HFR (HF rejection), LFR (LF rejection)	
Digital memory		
Maximum sampling rate	One-shot = 250 MS/s (2 channels), 500 MS/s (one channel) Repetitive = 50 GS/s	One-shot = 500 MS/s (2 channels), 1 GS/s (1 channel) Repetitive = 50 GS/s
Vertical resolution	8 bits (vertical resolution 0.4 %)	
Memory depth	Max. depth = 32 kpoints "Unlimited" storage capacity (USB key)	Max. depth = 2 Mpoints (long MEM) "Unlimited" storage capacity (USB key)
File management	Trace files (proprietary format and ".CSV" format compatible with spreadsheets) for the signals / Complete instrument configuration files / Screenshot files (Windows-compatible ".bmp" files)	
PEAK DETECT mode (capture of transients)	Minimum event duration = 10 ns	
Display modes	Points or vectors Modes: Persistence (1 s, 2 s, 5 s, 10 s, 20 s or infinite) or Averaging (factor from 4 to 256)	
XY mode	Yes	
Other functions		
AUTOSET	AUTO adjustment of amplitude, time base and trigger position	
MATH functions on the channels	Trace calculated in "real time": CH1 and CH2 : addition, subtraction, multiplication, division	
FFT analyser	FFT calculated on 1,024 points / Simultaneous display of trace + FFT / 4 window types (rectangle, Hamming, Hanning, Blackmann)	
Manual measurement cursors	Manual, tracking and automatic modes	
PASS / FAIL	Pass / Fail on the basis of a limit envelope or a template	
Recorder	Slow recording mode for signals > 100 ms (ROLL 6 Mpoints)	
Automatic measurements	32 time or level measurements	
Probe calibration signal	Yes	
Warranty	2 years	

 CONTENTS

1 DOX digital analyser-oscilloscope, European mains power cable, 2 switchable voltage probes (1/1 and 1/10), USB A/B cable, CD-ROM containing PC software and user's manual

DOX 2070B version:
delivered with demonstration board for practical exercises: HX0074

 TO ORDER

2 x 25 MHz digital oscilloscope	DOX2025B
2 x 70 MHz digital oscilloscope	DOX2070B
2 x 100 MHz digital oscilloscope	DOX2100B

 ACCESSORIES

See page 212

DOX3000 FAMILY

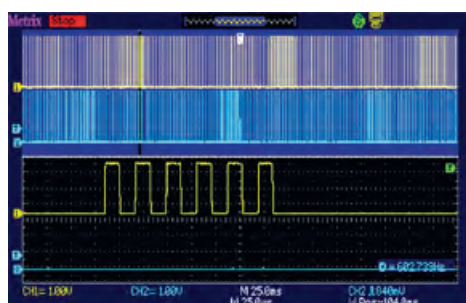
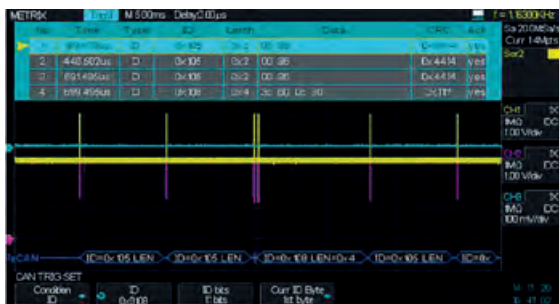

COMPREHENSIVE WITH HIGH PERFORMANCE

100 and 300 MHz bandwidth with built-in 25 MHz generator and serial bus decoding

4-channel oscilloscopes with TFT screen 8 inches wide offering 256 levels of colour intensity.

Display using **Sensitive Phosphor Oscilloscope** technology for optimized waveform capture: 110,000 wfs/s, exceptional acquisition and display functions for precisely reconstructing a signal.

Maximum acquisition memory depth: **28 Mpoints**.

Practical, intuitive HMI with traditional front-panel commands (rotary knobs with lighting), 5 languages selectable by menu (English, French, Spanish, Italian and German) plus help in French and English.

High-performance oscilloscope with maximum sampling rate of up to 2 GS/s in real time, vertical sensitivity from 2 mV/div. to 10 V/div. and from 1 ns to 50 s/div with complex and complete triggers (Pattern, windows, interval, Dropout, runt).

A built-in **25 MHz arbitrary signal generator** with programming software is included.

Serial bus decoding function with integrated triggers: I2C, SPI, UART, CAN, LIN and MSO **8-channel digital logic analyser** for analysing digital transmissions (DOX-MSO3LA option).



Easy analysis with 32 automatic measurements and statistical chart, manual cursor measurements and advanced math functions: simultaneous display of trace + 4-channel FFT.

Communication: USB host, USB key and device (PC, Pictbridge printers) and Ethernet.

CONTENTS

1 DOX digital oscilloscope, European mains power cable, 4 x 1/10 voltage probes, 1 USB cable, USB key containing software, user's manual and practical training exercises

Demonstration board available for practical exercises: HX0074





SPECIFICATIONS

	DOX 3104	DOX 3304
Interface		
Screen	Colour 8" TFT LCD screen, 800 x 480 pixels, 24 bits	
On-screen display	On 8x14 div with 4 channels + reference + Math functions and statistics table – full screen Vector or point modes with interpolation, permanent SPO mode: normal or colour	
Language	English, French, German, Italian and Spanish	
Vertical deflection		
Bandwidth	100 MHz - Bandwidth limiter: 20 MHz	300 MHz - Bandwidth limiter: 20 MHz
No. of channels	4 channels + 1 external channel	
Max. input voltage	300 V (DC+AC Pk)	
Vertical sensitivity	12 calibres from 2 mV to 10 V/div – Accuracy ±3% – 8-bit resolution	
Rise time	< 3.5 ns	< 1.2 ns
Probe compensation factors	x 0.1 / 0.2 / 0.5 / 1 / 2 / 5 / 10 / 20 / 50 / 100 / 200 / 500 / 1,000 / 2,000 / 5,000 / 10,000	
Horizontal deflection		
Time base speed	1 ns/div to 50 s/div (oscilloscope)	
Max. no. of traces captured per second	110,000 traces/s	
Horizontal zoom	Compression, expansion	
Auto ROLL mode	100 ms/div to 50 s/div (1-2-5 step)	
Trigger system		
Sources/Mode	CH1, CH2 or CH3. CH4 Ext, Ext/5, AC line / Auto, Normal triggered, One-shot Edge, Pulse (20 ns to 10 s), Slope (rising, falling), Video (NTSC, PAL, SECAM), Windows, Interval, Dropout, Runt, Pattern	
Type	I2C, SPI, UART/RS232, CAN, LIN	
Trigger on serial bus and decoding	Option : 8 channels + clock for TTL/CMOS/LVCOM/CUSTOM signals	
MSO logic analyser input	Option : 8 channels + clock for TTL/CMOS/LVCOM/CUSTOM signals	
Acquisition		
Real-time sampling frequency	2 GS/s	
Vertical resolution	8 bits (vertical resolution 0.4 %)	
Acquisition depth	Up to 28 M: 14 Mpts per channel, adjustable: 7 k / 14 k / 70 k / 140 k / 700 k / 1.4 M / 7 Mpts	
File manager	Trace files (DAV proprietary format and Excel-compatible ".CSV" format) ".set" configuration files – ".bmp" screenshot files	
Acquisition	Normal, Peak detect, Average, High res	
Peak detection	Minimum event duration = 10 ns	
"Statistics" mode	Event measurement	
Other functions		
AUTOSET	AUTO adjustment: amplitude, time base and trigger	
MATH function	Trace calculated in real time: CH1, CH2, CH3 CH4 +, -, x, /, (d/dt), integral (∫dt) and square root (√)	
FFT analyser	FFT calculated on 1,024 points - simultaneously with the waveform for the 4 channels Adjustable windowing: rectangular, Hamming, Hanning, Blackmann	
Cursors	Manuel, Track and Auto modes	
PASS/FAIL	Pass/Fail mode with specific terminal for envelope adjustment	
Automatic measurements	32 measurements and statistical table	
Built-in 25 MHz function generator	25 MHz- 125 MS/s - 14 bits - arbitrary function generation with EasyWave	
General specifications		
Recording	Internal memory or USB flash memory on front panel	
Printing	Via USB Host (PictBridge)	
Communication on PC	Via USB device or Ethernet link for EASYSCOPE (OX) and EASYWAVE (GX) software	
Power supply	Universal 100-240 V / 45-440 Hz/ 50 VA max. with removable cable	
Safety / EMC / Locking	Compliant with the IEC 6101-1 standard, 300V CAT I - EMC as per EN61326-1 - Kensington lock	
Temperature	Operation: 0 °C to +40 °C - Storage: -20 °C to +60 °C	
Mechanical specifications	352 x 111 x 224 mm – 3.6 kg (4 channels) – IP 20 3-year warranty	

TO ORDER

Oscilloscope (300 MHz, 4 channels) + arbitrary generator + serial bus decoding	DOX3304
Oscilloscope (100 MHz, 4 channels) + arbitrary generator + serial bus decoding	DOX3104
MSO 8-channel logic probe	DOX-MS03LA

ACCESSORIES

See pages 212

SOFTWARE FOR DOX FAMILY OF BENCHTOP OSCILLOSCOPES

EASYSCOPEX is the PC data processing software for the oscilloscopes in the DOX family.

It can be used to extend the oscilloscope's functions via USB (without drivers) or Ethernet (DOX 3000), depending on the models, for:

- Recovery of the .csv trace files
- Transmission of programming commands (SCPI format)
- Remote command test via VIRTUAL PANEL
- Recovery of screenshots in .bmp format

Available at the rear of the instrument:

- Input channel for the Pass/Fail mask test, ideal for quickly identifying problems on a signal
- Input channel for external triggering
- PC/device communication interfaces: USB or Ethernet
- Slot for KENSINGTON lock for greater security



EASYWAVE is PC software which allows users to:

- Recover the curves from the oscilloscope mode and then modify the waveforms using drawing tools
- Transfer or import waveforms into the ARbitrary function (4 memory locations)
- Consult the file library (sine, square, ramp, pulse, noise, cardiac, exponential, etc.) in the memory of the oscilloscope's generator mode

These software products are available from the DOX Support section on our website.

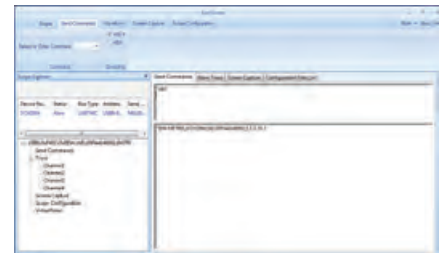

Transmission of SCPI commands

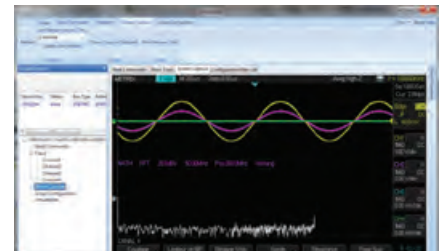

Screenshots

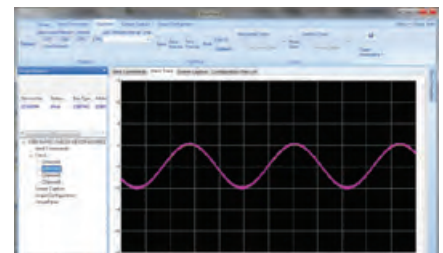

Recovery of traces

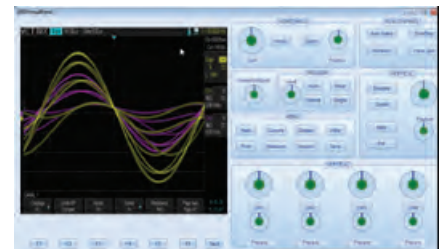

Virtual panel

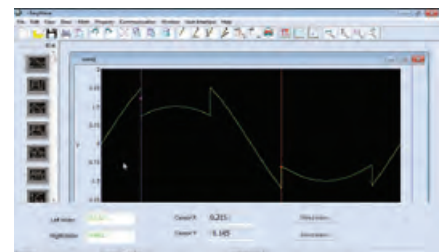

Creation of waveforms



SELECTION FAMILIES	MULTIFUNCTION "STAND-ALONE"				
	SCOPIX IV				HANDSCOPE
	FIELDBUS	ELECTRONICS	ELECTRICAL	INDUSTRIAL	MAINTENANCE
	OX9302 BUS	OX9304	OX9104 OX9102	OX9062	OX5022B OX5042B
Bandwidth	300 MHz	300 MHz	100 MHz	60 MHz	20 and 40 MHz
Channels (number/type)	2 isolated	4 isolated	2 or 4 / isolated	2 isolated	2 isolated
IEC61010 safety	CAT-II 1000V/CAT-III 600V				
One-shot digital sampling	2.5 GS/s	2.5 GS/s	2.5 GS/s	2.5 GS/s	50 MS/s
Repetitive mode with max. scale	100 GS/s	100 GS/s	100 GS/s	100 GS/s	2 GS/s
Vertical resolution	12 bits	12 bits	12 bits	12 bits	9 bits
Scaling/physical unit	•/•	•/•	•/•	•/•	•/•
Ethernet/Wifi PC communication	•/•	•/•	•/•	•/•	
ScopeNet PC web server	•	•	•	•	
Ni-MH/LI-ION battery	-/•	-/•	-/•	-/•	•/-
"Oscilloscope" specifications					
Min. input sensitivity	156 µV/div in zoom mode – 2.5 mV/div				5 mV/div
Max. input amplitude	200 V/div				200 V/div
Analogue filters	15 MHz, 1.5 MHz, 5 kHz	15 MHz, 1.5 MHz, 5 kHz	15 MHz, 1.5 MHz, 5 kHz	15 MHz, 1.5 MHz, 5 kHz	1.5 MHz, 5 kHz
Time base (per division)	1 ns-200 s	1 ns-200 s	1 ns-200 s	1 ns-200 s	25 ns-200 s
Roll mode / XY mode	•/•	•/•	•/•	•/•	•/•
Memory depth	100 k/channel > 2 GB on SD card (all formats)	100 k/channel > 2 GB on SD card (all formats)	100 k/channel > 2 GB on SD card (all formats)	100 k/channel > 2 GB on SD card (all formats)	2.5 k/channel - 2 MB memory
Acquisition memory					
No. of reference or math curves on screen	4	4	4	2	2
Automatic measurements/cursors	20/•				
Pulse trigger width/number	•/•	•/•	•/•	•/•	-
Adjustable Hold-Off / delay	•/•	•/•	•/•	•/•	-
Calculation functions: + - / x / : / advanced	•/•/•/•	•/•/•/•	•/•/•/•	•/•/•/•	•/•/•
Autoset with channel selection	•	•	•	•	•
Other functions					
FFT Lin & Log spectral analysis	12 bits / 72 dB+ waveform	12 bits / 72 dB+ waveform	12 bits / 72 dB+ waveform	12 bits / 72 dB+ waveform	-
TRMS multimeters	200 kHz	200 kHz	200 kHz	200 kHz	50 kHz
Logger	Recording in MULTIMETER mode, 100 kpts file				
Harmonic analysis	63 orders	63 orders	63 orders	63 orders	31 orders
Threshold recorders (no. of channels)	2	4	2 ou 4	2	2
Power / Power Harmonics measurement	•/-	•/-	•/-	•/-	•
General specifications					
7/3.5"colour LCD screen	7"	7"	7"	7"	3.5"
100% "closed casing" software calibration	•	•	•	•	•

SCOPIX IV, A RANGE OF 5 REFERENCES



The 14th generation of SCOPIX oscilloscopes: a range of 4 general-purpose references and one product reference specialized in BUS testing.

From the laboratory to the field, whether placed flat, suspended or carried, a single multifunction diagnostic instrument with isolated channels is all you need: sober, rugged and complete, the alliance of technology and field expertise in one oscilloscope.

OSCILLOSCOPES WITH ISOLATED CHANNELS FOR HIGH-PERFORMANCE MEASUREMENT OF ELECTRICAL QUANTITIES

- Practical and easy to use, this generation of on-site oscilloscopes with software organized by tablet/smartphone icons developed on a LINUX operating system
- Optimized display with a backlit 7-inch WVGA colour touch screen organized into areas: upper display area for zoom and FFT, lower area for the measurement parameters.

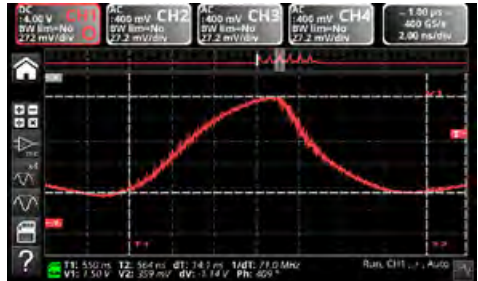

- New mechanical technologies, with a 30-key silicone keypad for direct commands, casing optimized for comfortable handling for work in industrial environments: IP54, resistant to dust, humidity and water droplets, as well as temperature variations. Noiseless because there is no fan. Supplied with stand and carrying strap
- Simplification of input terminals with Probix "plug&play" smart sensors: safety, power supply via Scopix, automatic recognition, automatic scaling
- All types of communication interfaces are available: USB and Wifi or wired Ethernet + μ SD + calibration signal grouped on the right-hand side of the product
- μ SD large capacity storage above 32 GB: SD, SDHC and SDXC cards, 1 GB internal storage
- Data processing tools: ScopeNet software for controlling "100 % of the functions", recovering the data, exchanging files on PC or SX-METRO software for data analysis on PC, as well as .png screenshots on network printers
- Battery life of one working day in the field with Li-ion battery > 8h (battery life indicator) or mains: removable battery without hatch to open, fast charging inside the instrument

HIGH PERFORMANCE: 5 COMPLEMENTARY TOOLS IN A SINGLE INSTRUMENT, WITHOUT CHANGING THE CONNECTIONS

- Oscilloscope + multimeter + FFT analyser + harmonic analyser and logger with simplified use
- OX: Bandwidth up to 300 MHz, on 2 or 4 isolated channels, 600 V Cat III – 1000 V with voltage probe
- Sampling rate 2.5 GS/s in one-shot mode and max. 100 GS/s in ETS zoom mode
- 100 K memory depth per channel (oscilloscope & logger). Standard "real-time" FFT analysis and "functions for simple" and complex calculations on the channels
- 2 or 4 multimeters + independent TRMS digital loggers, bandwidth 200 kHz
- Powerful, with a latest-generation high-speed microprocessor offering 12-bit resolution

MEASUREMENT OF ALL SIGNALS

- Digital isolation of the channels between one another and in relation to the earth, 600 V CAT III



INTEGRATED MODES OF THE ANALYTICAL TOOLS FOR USE WITHOUT CHANGING THE MEASUREMENT INPUT

OSCILLOSCOPE MODE: 2 OR 4 CHANNELS, 60 TO 300 MHZ

Complete automatic measurements for precise analysis display all the 20 parameters of a signal all together or for each of the four channels, as well as the 2 markers allowing you to view the portion of the signal where the first automatic measurement was made. A specific measurement area can then be selected by framing it with manual cursors for more reliable and accurate results.

It is possible to compare two traces directly by checking "deviation from reference memory" so that the signal's 20 parameters are shown as deviations.

The MATH functions (1, 2, 3 and 4) can be used to define, for each of the traces, a mathematical function and vertical scaling with the definition of the actual physical unit. The screen of the mathematical editor can display up to 4 traces in real time. Automatic or cursor measurements remain available. This means it is possible to examine waveforms such as the power, for example (U x I), and perform all the related measurements. Many operators are available, such as +, -, x, /, but more complex functions such as sine, cosine, exponential, logarithm, square root and even derivative and integral, etc., at last opening the way for specific applications.

The real-time Fast Fourier Transform (FFT) for frequency decomposition of your signals.

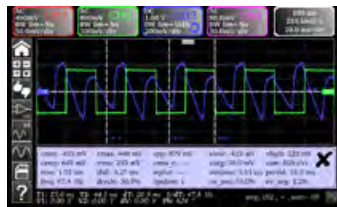

The FFT function is used to calculate, on the basis of 2,500 points, the discrete representation of a signal in the frequency domain alongside its simultaneous representation in the time domain. It is often crucial for developing an effective diagnosis during qualitative analysis of the signals measurement of the different harmonics.

Several weighting windows are available, as well as 2 representation modes (linear or logarithmic, scale in dB). The 2 cursors can then be used for precise measurement of the frequency lines, the levels and the attenuations, taking advantage of the 80 dB dynamic range permitted by the 12 bits / 2.5 GS/s conversion.

The Autoset function makes it easier to obtain an optimum spectral representation on which a graphical zoom can be applied to analyse all the details of the spectrum.

MULTIMETER MODE

By simply selecting the dedicated pictogram, you can access the multimeter without changing the input channel:

- amplitude (DC or AC voltage and current, power, temperature, etc.)
- resistance, continuity, capacitance
- SMD tests, etc.

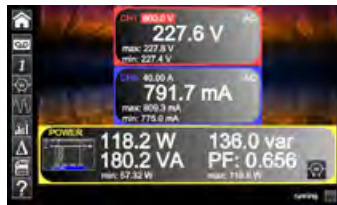

Temperature can be measured with PROBIX Pt 100 sensors or K thermocouples for direct measurements in °C.

The Logger mode is associated with Multimeter mode so that you can view the trends.

POWER

Power measurements are proposed with a choice of three configurations:

- single-phase power
- three-phase power on balanced network without neutral
- three-phase power on balanced network with neutral

LOGGER MODE WITH AUTOMATIC RECORDING

Since version 1.05 of the firmware, it is possible to analyse the events in the Logger mode's Viewer by means of search criteria and a duration; if it is possible to select an event, the cursors are displayed.



Logger mode: recording of the trends from the Multimeter mode, simple switching between the two modes.

For monitoring the variations of physical or mechanical phenomena over time, a genuine fast graphical digital logger is integrated into the instrument to replace paper recorders. The recordings have a fixed duration of 20,000 s with a sampling interval of 0.2 seconds and are automatically saved in N files of 100 kpts.

HARMONICS MODE

Harmonic analysis is performed up to the 63rd order to meet the requirements of the EN 50160 standard (THD on 50 orders minimum), with a fundamental frequency between 40 and 450 Hz. It is possible to preselect the frequency of the fundamental for the standards (50 Hz, 60 Hz and 400 Hz). This function helps to improve analytical performance and above all allows measurement when the level of a harmonic order is greater than the level of the fundamental. It is possible to view harmonic analyses on two or four channels simultaneously.

"BUS ANALYSIS" MODE YOU CAN SELECT "BUS ANALYSIS" MODE BY PRESSING AN IMAGE; ALL THE TESTS ARE AUTOMATIC ONCE YOU HAVE CHOSEN THE BUS.

- 1 - Choice of the bus among ASI-DALI-CAN-KNX-ETHERNET-MIL STD1553-ARINC159-USBFLEXRAY-LIN-PROFIBUS-RS232/RS485 in a list with different speeds,
- 2 - Measurement limits or tolerances of the bus chosen,
- 3 - Diagnosis,
- 4 - Indication of diagnosis with elements to be checked.

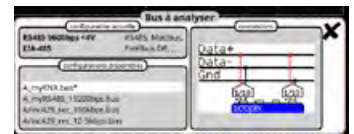

- Choice of the bus by means of the BUS configuration icon

Display of all the definition files for bus tests according to the different speeds.

- Selection of one of the files before starting analysis; for each bus: reminder of the configuration: standard and speed, limits and type of protocol.

On the right, a "connection" area shows details of the probe connections for each channel.

- Analogue analysis of the bus chosen beforehand.

Display during automatic diagnosis
Display of the measurement tolerances

• TOLERANCES

To analyse the current bus, you need to view the tolerances assigned to each measurement.

These tolerances may be modified by the user; the bus will then be displayed with an asterisk (*) beside the filename.

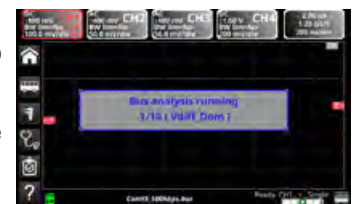

• RESULTS

Display of the results from the last analysis available.

These results can be saved in a ".htm" file in the internal memory or on the SD card and can be reopened in a text editor.

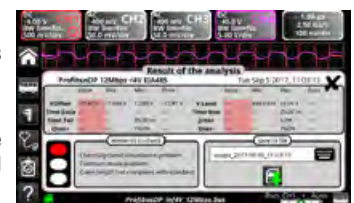

Order	Frequency (Hz)	Amplitude (V)	Phase (deg)
1	50	227.6	0
2	100	15.2	120
3	150	8.5	240
4	200	5.1	360
5	250	3.2	180
6	300	2.1	0
7	350	1.5	120
8	400	1.0	240
9	450	0.7	360
10	500	0.5	180
11	550	0.4	0
12	600	0.3	120
13	650	0.2	240
14	700	0.15	360
15	750	0.1	180
16	800	0.08	0
17	850	0.06	120
18	900	0.05	240
19	950	0.04	360
20	1000	0.03	180

OX 9302-BUS



A genuine SCOPIX IV oscilloscope with all its modes and tools - plus the BUS function!

STRENGTHS

- 1 key to start analysing
- 4 steps to qualify a data bus
- Intuitive, upgradable Human-Machine Interface
- Multi-interface communication
- Customization of your fieldbus with the SX-BUS software delivered with the product
- Verification of the transmission quality of signals using fieldbus protocols: KNX, DALI, CAN, LIN, FlexRay™, AS-i, Profibus®, RS-485, RS-232, Ethernet, etc.

SPECIFICATIONS

OX9302-BUS	
Type of display	7" TFT WVGA LCD colour touch screen, 800 x 480 pixels LED backlighting (adjustable automatic standby)
Bandwidth	300 MHz
Number of channels	2 isolated channels



The **SCOPIX IV BUS** function can be used to perform the electrical measurements needed to assess the integrity of the fieldbuses, or in other words the operation of the physical layer (electrical specifications, synchronization, etc.), according to the applicable standards.

Once diagnosis of the bus has begun, it proceeds step by step, with the possibility of viewing the calculation of the various parameters imposed by the standard.

Efficiency: if the diagnosis stops before the measurements have ended, it means that the minimum level and amplitude criteria are not satisfied, so the other parameters cannot be calculated.

- 1- Choice of the bus to be analysed from a list.
- 2- Display of the measurement tolerances.
- 3- Analysis of the bus according to the associated standard.
- 4- Result of the analysis with assistance for interpretation.

SCOPIX BUS proposes help with connection according to the bus to be checked, along with the corresponding wiring diagram.

The five **HX0190** and **HX0191** boards delivered help you with the connections: these boards are equipped with SUBD9, RJ45 or M12 connectors or 8-wire screw connectors which are the main technologies used for connection to fieldbuses.



TO ORDER

1 oscilloscope 2 x 300 MHz BUS

OX9302-BUS

The functions and performance of the SCOPIX IV models have been improved. For example, their bandwidth has been increased, as have their recording possibilities, their storage capacity, etc., and this evolution will continue to facilitate your measurements.

Selection families	Scopix IV		
	Electronics	Electrical	Industrial
	OX9304	OX9104 OX9102	OX9062
Bandwidth	300 MHz	100 MHz	60 MHz
Channels (number/type)	4 isolated	2 or 4 / isolated	2 / isolated
Analogue filters	15 MHz, 1.5 MHz, 5 kHz		
One-shot digital sampling	2.5 GS/s		
Max. scale repetitive mode	100 GS/s		
Vertical resolution	12 bits		
Safety as per IEC61010	600 V Cat III		
Display mode	Vector, envelope, entire acquisition		
Type of signals	Automatic ROLL (> 100 ms), repetitive, min/max		
Averaging	2/6/16/64		
"Oscilloscope" specifications			
Min. input sensitivity	156 µV/div (zoom) – 2.5 mV		
Max. input amplitude	200 V/div		
Time base (per division)	1 ns - 200 s		
FFT+signal mode	2,500 pts, logarithmic and linear scale, weighting window		
XY mode	Depending on time base X(T) + waveform		
Memory depth	100 kpts / channel		
Acquisition memory	> 2 GB on SD card (all formats, µSDHC/XC cards)		
Automatic measurements/cursors	20 automatic measurements + cursors		
Edge trigger	Rising or falling on 2 or 4 channels		
Pulse trigger	< T1 ; >T2 ; or between T1 and T2: [16 ns, 20 s]		
Delay trigger	48 ns to 20 s and trigger on 2 or 4 channels		
Counting trigger	3 to 16,384 events and trigger on 2 or 4 channels		
Adjustable Hold-Off / Delay	Adjustable from 64 ns to 15 sec		
Calculation functions	Simple + - / x / : / and advanced: complex functions, integral, derivative		
Autoset	With channel selection		
Other functions			
TRMS multimeters	200 kHz	200 kHz	200 kHz
Logger	REC in Multimeter mode / 100 kpt file / period 0.2s		
Harmonic analysis	63 orders, V _{rms} , global THD and per order		
No. of channels / Viewer	4	4 or 2	2
Power measurements	Single-phase, three-phase, display – Active, reactive and apparent power, PF + t MIN/MAX		
General specifications			
Colour screen	7" wide - Resolution 800 x 480 pixels		
LI-ION battery	Battery life: 8 hours		
Recording conditions	1 GB internal data storage, 2 GB to 2 TB µSD card		
Communication – RJ45/Wifi	ScopeNet IV for PC and SX-METRO/P software (option)		

CONTENTS

1 SCOPIX IV oscilloscope delivered with a carrying bag, 1 PA40W-2 mains power pack/charger and 1 2P EURO mains power cable, 1 Li-Ion battery pack, 1 stylus, 1 Ethernet cable, 1 USB cable, 2 safety leads (red, black), 2 x Ø 4 mm test probes (red, black), 2 or 4 voltage probes depending on model, 1 µSD card (8 GB), 1 USB / µSD adapter, 1 wrist strap, 1 PROBIX BANANA connector, 1 USB installation procedure for use of the ScopeNet data export software on CD-ROM, 1 PDF user's manual on CD (more than 5 languages), 1 Quick Start Guide on paper and 1 safety datasheet in 20 languages.

ACCESSORIES

SX-METRO/P	p53
See PROBIX accessories	p50

TO ORDER

1 oscilloscope 2 x 60 MHz	OX9062
1 oscilloscope 2 x 100 MHz	OX9102
1 oscilloscope 4 x 100 MHz	OX9104
1 oscilloscope 4 x 300 MHz	OX9304

ADVANTAGES OF THE PATENTED PROBIX SYSTEM

ProbiX

Scopix portable oscilloscopes benefit from ProbiX smart accessories which offer users a host of innovative functions guaranteeing simplicity, effectiveness, versatility and safety.

The ProbiX system, with its smart probes, accessories and adapters, ensures quick, error-free implementation of your instrument.

With this "plug and play" measurement system, the probes and adapters are recognized immediately as

soon as they are connected. The instrument does not just identify them, however. It also gives information on their specifications.

Active safety is built-in, notably in the form of safety information and recommendations for users based on their specific configuration.

The coefficients, scales, units and channel configurations are managed automatically.

This system also allows users to power the accessories directly from an oscilloscope, without a battery or additional mains adapter.

Some ProbiX accessories include three control buttons directly accessible on the probe. For example, the first two control buttons on the probes are used for direct modification of the parameter settings for the channel to which they are connected.

PROBIX MEASURING ACCESSORIES (CURRENT, VOLTAGE, TEMPERATURE)

	Image	Connections									Measurement range	Measurement type
		Ratio	Probe	BNC	Banana	Clamp	AmpFLEX	SK1-20 Mini AmpFLEX	SK1-19 sensors	SP10-13 sensors		
HX0130		1/10	•								300 V CAT II 500 MHz	Voltage-Resistance-Capacitance-Tester
HX0030C		1/10	•								600 V CAT III 250 MHz	Voltage-Resistance-Capacitance-Tester
HX0031				•							600 V CAT III 250 MHz	Voltage-Resistance-Capacitance-Tester
HX0032				•							30 V CAT I 250 MHz	Voltage-Resistance-Capacitance-Tester
HX0033					•						600V CAT III	Voltage-Resistance-Capacitance-Tester
HX0093					•						600 V CAT III 300 Hz filter	Voltage-Resistance-Capacitance-Tester
HX0034B						•					0.2 - 60 Arms 1 MHz	Current
HX0072		∅26 mm					•				5 - 300 Arms 200 kHz	Current
HX0073								•			1 - 300 Arms 3 MHz	Current
HX0094					•						4 - 20 mA	Current
HX0035B									•		-10 °C to +1,250 °C	Temperature K thermocouple
HX0036										•	-100 °C to +500 °C	Temperature Pt100 sensor

PROBIX ACCESSORIES

Specifications	ProbiX	Other accessories
SMD banana lead	HX0064	HX0033
Industrial accessories kit	HX0071	HX0030C
µSD-SD	0X 9XXX	HX0179
USB-SD	0X 9XXX	HX0080
Demo. test circuit	0X 9XXX	HX0074
BNC/BNC	HX0106	HX0031
	45 A _{AC}	MA200
	60 A _{AC}	MN60
100mV clamps	200 A _{AC}	C160
	45 A _{AC/DC}	HX0102
		HX0031

FIND ALL THE AVAILABLE ACCESSORIES, SENSORS AND CLAMPS IN THE ACCESSORIES CHAPTER.

THE COMMUNICATION TOOLS IN SCOPIX IV

The communication interfaces are grouped in a dedicated area on the right-hand side of the product and are protected by plugs: USB host, wired or Wifi Ethernet for communication with a PC or printing on a network printer and high-capacity µSD card for storing the data without transfer problems.



You can choose the type of communication to suit your changing requirements:

- RJ45 wired Ethernet LAN with integrated DHCP server for simple connection to your network and the possibility of activating the Wifi radio link to communicate with a PC.
- USB type A to interface with a PC to save, recall or load configurations.
- µSD card for storing data and upgrading the firmware; this direct interface does not require a link.

FILE MANAGEMENT

It is possible to save the traces from the oscilloscope mode in two formats: .trc so that they can be recalled to the screen or.txt for direct export into another standard "Windows" application, such as a spreadsheet, for example.

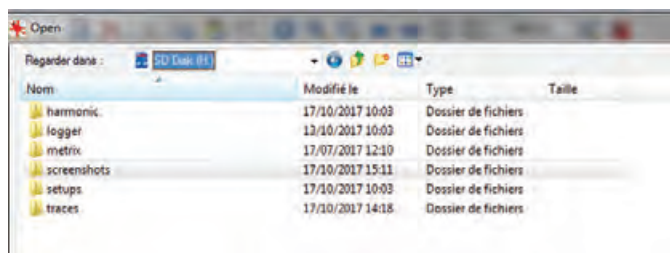

It is also very simple on the oscilloscope's front panel to take screenshots in .png format (stored in the screenshot directory), print on a network printer and transfer or delete files in the file manager.



In each mode, the configuration can be saved to simplify your settings.

DATA PROCESSING



- On the oscilloscope, recall of .trc curves stored in the memory by means of a png viewer.
- On a PC, with the ScopeNet application in your web browser via USB or Ethernet: remote control, programming using SCPI commands or via the **SX-METRO** software.
- The multiple communication tools with SCOPIX IV will enable you to view the curves in real time on a PC, perform additional measurements and analyses remotely, take screenshots and control your oscilloscope. SCOPIX IV provides comprehensive post-acquisition expert functions.

APPLICATION FOR SCOPIX IV

ScopeNet IV

- ScopeNet IV is a PC application which uses Ethernet communication (wired RJ45 and Wifi)

The ScopeNet IV PC application for SCOPIX IV can be used to:

- control and configure the oscilloscope remotely
- display the acquisitions as curves in all the modes
- recall or save instrument configurations,
- make and recall screenshots in .png file format.

It can also be used to :

- recover files from the SCOPIX IV remotely,
- take screenshots which are then placed in the clipboard.

There is no function for exporting the data into Excel because a .txt text editor is available on the instrument; it converts .rec and .trc files into .txt files so that the points can be used in a spreadsheet such as Excel:

The memory card appears in the tree-structure as "sdcard-p1"

File manager

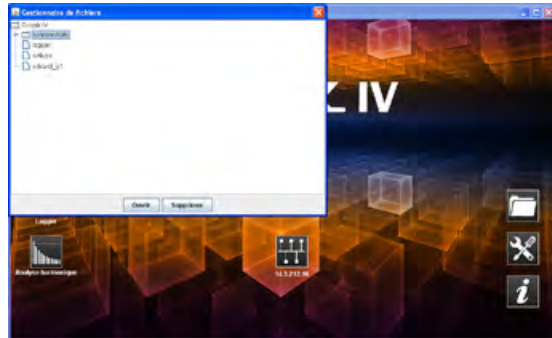

Multimeter



Logger

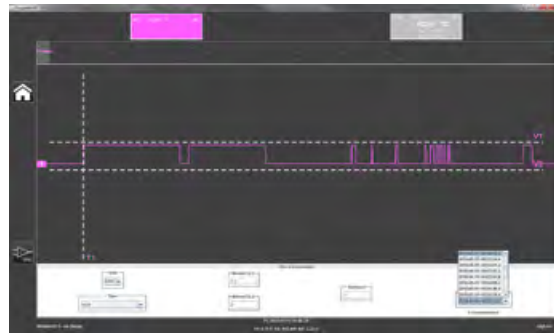

Oscilloscope

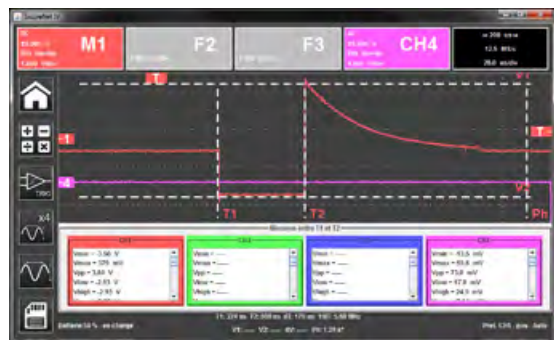

Harmonics



Practical

No need to install Scopenet on the PC. The application opens directly with most web browsers.

Android application ScopeNet for Scopix III

(available from Google Store)

ScopeNet for remote dialogue and configuration using a tablet or smartphone.

This can be used to view the curves in real time, perform measurements and analyses, capture screens and control METRIX oscilloscopes METRIX with your tablet or smartphone.



SX METRO

USB-RS232 or Ethernet link

The METRIX oscilloscope software for:

- Viewing the curves: up to 5 per screen
- Displaying the curves on a PC in real time as well as on the oscilloscopes
- Controlling the oscilloscope remotely with the PC
- Loading a configuration into the oscilloscope
- Importing curves stored in the oscilloscope's memory as "image" files
- Storing the curves in text format on the PC
- Performing mathematical processing such as FFT on the signal viewed
- Transferring the data (curves or FFT) into Excel

File format	Contents
*.trc	a curve which will be displayed in the active graph.
*.rec	a recording which will be displayed in a new graph.
*.cfg	configuration.
*.bmp	SCOPIX III screenshot.
*.grf	graph with curves and comments.
*.per	a curve in persistence mode.
*.png	SCOPIX IV screenshot.
*.BUS	Bus analysis file.

Reminder of the **communication at the foot of the SX METRO screen**: the status bar shows the type of connection to the oscilloscope and the real-time control options.

- 1- **Control**: for directly activating remote control of the oscilloscope.
- 2- **ScopeNet IV**: for starting the JAVA application for SCOPIX IV.

SX METRO offers a help file which refers to a .pdf file of the SX METRO user's manual. The SX-METRO software is regularly upgraded, so we advise you to check your version is the same as the version present on our support website <https://www.chauvin-arnoux.com/fr/support/telechargement/results/nid/19946> The same applies to the SCOPIX IV firmware.

<https://www.chauvin-arnoux.com/sites/default/files/download/x04726k00.zip>

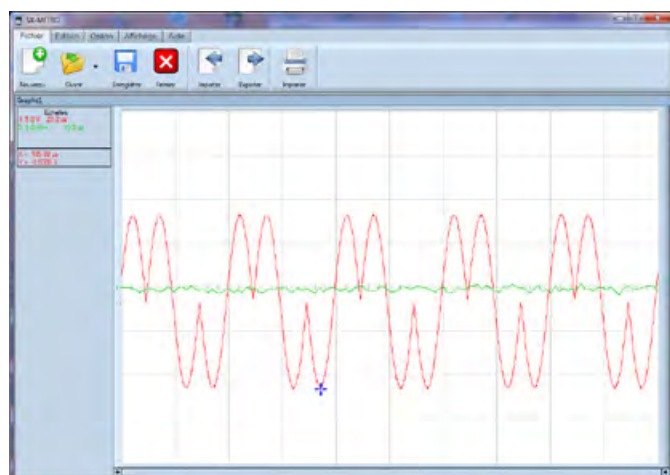

The 5 tabs accessible in SX METRO

1- "File" groups file creation, data backup or window closure, file import from the oscilloscope's memory or export of traces or configurations into the memory.

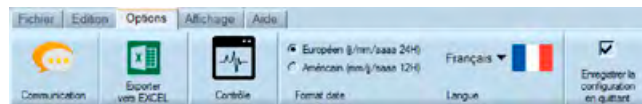

2- "Edit" proposes processing of the window, addition of text and screenshots.



3- "Options" manages the type of communication according to the output port or cable used, the settings for the communication parameters, a function for exporting trace files into Excel and the choice of one of the 5 languages proposed.

Options/control allows you to view the instrument's front panel in real time with the parameter settings.

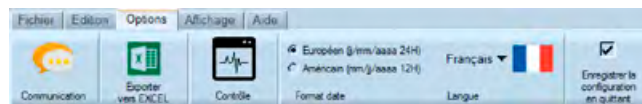

4- "Display" of the crosshairs, deviation cursors and different screen sizes for optimized viewing.

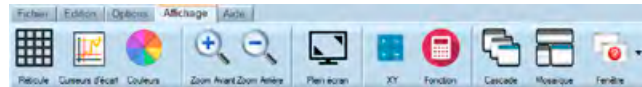

With the colour function, you can modify the colours of the different objects in the SX-METRO window and thus print your curves in the format you wish in order to optimize printing according to your printer.

5- "Help" calls up a .pdf of the SX METRO User' Manual; a link to an upgrade file on our support website has been added. This website also indicates the current SX METRO version.



ACCESSORIES

USB/microSD adapter: HX0080

TO ORDER

Software for OX7000, OX9000, OX6XXX and OX5XXX

SX-METRO/P

SIMPLE, EFFECTIVE INSTRUMENTS FOR MEASUREMENTS IN THE LABORATORY

A large number of measuring instruments are necessary to design new instruments and systems in R&D laboratories. The engineers and technicians responsible for designing electronic, IT and process control systems use a wide range of measuring instruments from the design phases through to testing and qualification. From the simplest to the most complex, from single-function instruments to multi-application models, the laboratory instruments from Metrix offer users a wide choice focusing on effectiveness and accuracy.



RESEARCH & DEVELOPMENT

During this phase, the main laboratory instruments required provide the following functions:

- Power supplies
- Signal generation
- General measurements
- Time and frequency analyses of the signals

To meet these requirements, we propose a set of simple, effective standard or programmable multichannel power supply solutions, as well simple and random function generators. When these generators are used with the SX-GENE software, they can simulate complex signals. In addition, the advanced functions and high accuracy of the benchtop multimeters in the MX5000 Series and the ASYC IV family allow you to measure the various electrical values of a circuit.

With our digital oscilloscopes offering, time and frequency analysis of the signal is guaranteed at bandwidths of up to a few hundred megahertz.

TESTS AND QUALIFICATION

Testing is now recognized as a specific profession which is essential for successful projects. It allows you to work on both technical and functional issues. Omnipresent throughout the development cycle, testing is an activity which draws on a wide range of knowledge and know-how, including the use of reliable, accurate instruments.

During this phase, tests are carried out to check both the system's performance and its ability to operate in its environment. Chauvin Arnoux proposes suitable measuring solutions for this to complement the instruments described above.

The numerous integrated functions of the Handscope and Scopix portable oscilloscopes with isolated channels can be used to perform measurements on integration platforms. Simultaneously multichannel oscilloscopes, multimeters, signal analysers (including of digital bus signals – conformity of time and levels) and loggers, they can be used to check and note the various points to be tested. Thanks to their communication interfaces and related software, the measurements are collected and made available to produce a measurement report.

The near-field probes used with the MTX1050 spectrum analyser can be used for initial diagnosis in terms of electromagnetic disturbances affecting a PCB.

FROM MIDDLE SCHOOLS... TO HIGHER EDUCATION

When studying Science and Technology, measurement is essential for assessing and understanding the theoretical phenomena through practical experiments. In both initial and higher education, it is important to determine the characteristics of a component or system, its behaviour in its environment and its evolution over time, using our measuring instruments

Our offering covers everything from easy-to-use instruments for initial training through to the more complex tools encountered by students when they start their working life.



SPECTRAL ANALYSIS

Spectrum analysis can be used to measure the band, detect disturbance lines, quantify phase jitter by direct reading, check the steps, determine the rated frequency, search for residual lines for comparison, etc.

HETERODYNE SPECTRUM ANALYSER

Spectrum analysis involves moving a narrow bandwidth filter in front of the signal to be analysed. However, because of the difficulty of producing a narrow bandwidth filter with an adjustable mid-band frequency, the problem is avoided by "heterodyning".

With this technique, the bandwidth filter has a fixed mid-band frequency of F0 and the signal to be analysed is modified by modulation, so that the different frequency components are successively modulated to the frequency F0. To achieve this, a multiplier is used which outputs the sum and the difference of the frequencies applied to the two inputs, resulting from the trigonometric relation: $\cos(a)\cos(b) = (1/2)[\cos(a+b) + \cos(a-b)]$.

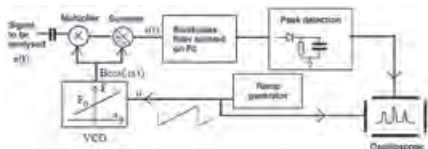

Block diagram of a heterodyne spectrum analyser

THE ANALYTICAL FILTER

The analytical filter is also called the resolution filter. The narrower the filter, the finer the analysis and the closer you get to the shape of the line analysed (because the filter itself resembles a line). Using different reasoning, it could also be said that a signal passing through an extremely narrow filter can only come out as a pure sine wave, represented by a line!

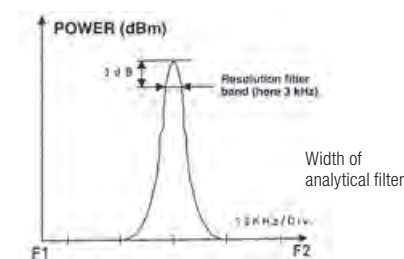

NOISE POWER AND POWER OF A LINE

The analytical filter indicates the power of the F0 line when it is centred on it (leaving aside the filter losses which can be compensated). Whatever the width of the filter, the maximum height of the curve on screen will correspond to the power of the line.

NOISE MEASUREMENT DEPENDS ON THE WIDTH OF THE ANALYTICAL FILTER

This means that phase jitter can be measured with the spectrum analyser, in dBc/Hz, which is the difference in dB between the F0 line power measurements in dBm and the noise power in dBm/Hz at a given distance from the carrier.

VIDEO FILTER

This serves to smooth the curve on the screen, particularly at the noise level. It has no effect on the actual measurement, as it only applies to the on-screen display of the curve. However, it may affect the sweep time: a 10 Hz video filter will not deliver more than 10 data items per second, so if 1,000 points are necessary to plot the curve, it will not be possible in less than 100 seconds.

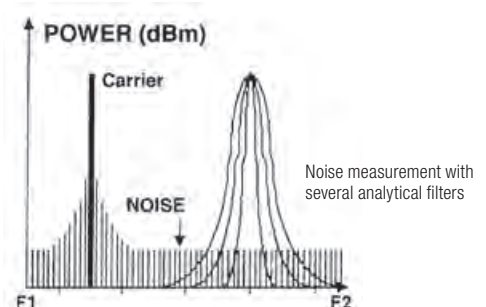

SELECTION GUIDE FOR LABORATORY INSTRUMENTS 197
 SPECTRUM ANALYSER 198
 GENERATORS FOR LABORATORY INSTRUMENTATION 200

LABORATORY POWER SUPPLIES 206
 PROGRAMMABLE POWER SUPPLY 207
 MULTIFUNCTION CALIBRATORS 208
 TRAINING BOXES AND SHUNTS 210

SELECTION GUIDE

WE PROPOSE A RANGE OF LABORATORY PRODUCTS FOR YOUR EXPERIMENTS AND PRACTICAL EXERCISES

The school and university labs used for practicals are traditionally equipped with stabilized or adjustable power supplies protected against short-circuits and function generators, from the simplest (sine, square and triangular waveforms) to the most complex (arbitrary signals) to complement the multimeters and oscilloscopes.

• Analyser

The **MTX 1050** is a very compact, ergonomical "screenless" instrument. Lightweight, portable, ideal for general-purpose applications, the MTX 1050 is particularly suitable for the needs of SME/SMLs and technical education (engineering schools, technical colleges, etc.).
 Laboratory **spectrum analyser** with PC software



• Generators

The **GX 3xx** models are 5 MHz to 20 MHz DDS function generators which provide significantly better accuracy and frequency stability than a classic generator. they generate precise, varied signals: sine, triangle, square & LOGIC waveforms with TTL output. The backlighting is adjustable and the contrast can be increased if needed. 15 complete configurations are stored in the memory of version -E of the GX 320, which is programmable via an ETHERNET link using the SCPI protocol.



The **GX 10xx** models are 25 MHz or 50 MHz arbitrary signal generators. They are accurate, stable and the signals are pure, with low distortion due to the 125MS/s sampling rate with 14-bit resolution. The SX-GENE v2.0 software can be used to control a GX 10xx arbitrary signal generator, save and restore configurations and generate arbitrary signals.

Simple and complex DDS function signal **generators**

- Frequency 5, 10 or 20 MHz
- 25 or 50 MHz arbitrary signal generators with SX GENE PC software

• Power supplies

The **AX50X** models are 30V/2.5A variable laboratory power supplies with 1, 2 or 3 channels. These power supplies are rugged but lightweight and economical and generate very little radiation.



The **AX1360-P** is a triple programmable regulated power supply with 2 adjustable outputs (0-30 V) and 1 selectable fixed output (2.5V / 3.3V /5V). The AX1360-P is simple to use as it allows you to change from a serial circuit to a parallel circuit without rewiring, by simple selection, and the switch between the 2 modes is automatic.

Stabilized laboratory-current power supplies for powering your circuits



Power supply selection guide

	AX501	AX502	AX503	AX1360-P
1 channel	•	•	•	•
2 channels		•		•
2 channels + 1 fixed			•	•
Tracking mode		•	•	•
Programmable				•

• Calibrators

Multifunction calibrators suitable for calibrating all types of measuring instruments/
 The **CX 165x** models include a built-in multimeter.

Laboratory calibrators



• Decade boxes and shunts

Single or multiple **laboratory decade** boxes for resistance, capacitance and inductance exercises

Laboratory shunts

MTX 1050



+ **ADDITIONAL INFO**

- When coupled with the H-field probes, the MTX1050-PC analyser can be used to carry out EMC prequalification tests.

★ **STRENGTHS**

- Particularly compact and economical "screenless" instrument
- User interface via PC: "Plug & Play" USB connection, large high-resolution colour display
- 4 simultaneous measurements (Peak auto, Marker, 2 difference cursors)
- Frequency range from 400 kHz to 1 GHz
- High stability with frequency drift limited to ± 5 ppm/year
- Wide dynamic range for measurement, from -90 dBm to +20 dBm
- 6 sweep speeds, 3 analytical filters and 3 video filters, built-in FM demodulation
- Ideal for EMC testing



PEAK cursor

Free cursor

DELTA cursors

Peak (MHz) 466.000 -46.9 dBm

Cursor (MHz) 490.800 -67.2 dBm

DELTA CURSORS

- 482.20 MHz -80.4 dBm
- 550.60 MHz -70.7 dBm
- 68.40 MHz 9.7 dB

SPECIFICATIONS

MTX 1050	
Frequency	15 MHz, 1.5 MHz, 5 kHz
Display	Colour display, high resolution, large dimensions, on PC screen Up to 5,000-point sweep in horizontal resolution (depending on speed)
Bandwidth	400 kHz to 1 GHz
Resolution on value / central frequency	4 1/2 digits / 10 kHz max.
Internal frequency	Accuracy $\pm 0.625 \cdot 10^{-6}$
Frequency stability	± 5 ppm / 1 year
Frequency span	Zero Span, 1 MHz to 100 MHz / div - sequence 1-2-5
Resolution	
Filters	12 kHz, 120 kHz and 1 MHz
Video filters	1 kHz, 10 kHz and 300 kHz
Level	
Dynamic range for input	3 ranges from -90 dBm to +20 dBm
Dynamic range for display	50 dB and 100 dB
Input	
Max. admissible power	Max. admissible power +25 dBm permanent, ± 30 V _{oc}
Impedance	50 Ω rated
Input attenuation	One 20 dB-rated attenuator, one 20 dB-rated amplifier
Connector	BNC
Markers / modes	4 simultaneous cursors / 1 automatic "Peak" detection marker, 1 cursor "locked" to the trace and 2 delta cursors
Functions	
Data storage	On PC, unlimited number, with explicit names Storage and comparison of reference spans 100 to 5,000 samples per sweep (depending on sweep speed)
PC communication	"Plug & Play" USB as standard
Mains power supply	230 V _{ac} , ± 10 %, 50/60 Hz, approx. 4 W
Safety / standards	IEC 61010-1 - CAT II / NF EN 61326-1: 98
Dimensions / weight	270 (L) x 63 (H) x 215 (W) mm / 1.7 kg



SPECIFIC ACCESSORIES

H field probes kit, 3 GHz	HX0082
20 dB amplifier for HX0082 probes	HX0083

CONTENTS

1 MTX, 1 mains power cable, 1 CD-Rom containing the PC application software, 1 FM antenna with BNC connection, 1 user's manual

TO ORDER

MTX 1050PC spectrum analyser	MTX1050-PC
------------------------------	------------

GENERATOR BASICS

Function generators are among the most widely-used test and measurement instruments. They can generate varied characteristic waveforms in order to test the operation of electronic systems, from very low frequencies of just a few mHz up to 20 MHz or more.

They allow users to adjust the amplitude of these signals up to 20 V or more, possibly with the presence of a DC component.

In addition, they may also provide modulations or specific functions.

DIRECT DIGITAL SYNTHESIS (DDS) FUNCTION GENERATOR

Basic principle:

DDS function generators generate periodic signals at precise frequencies by choosing samples in the memory rather than producing all the samples of a signal. This technique offers exceptional accuracy and stability, high spectral purity, low noise and excellent frequency agility. It is possible to modify the frequency without phase discontinuity.

It is important to note that signal generation with the DDS method differs significantly from the method used by an arbitrary signal generator.

For arbitrary signal generation, each sample of the signal period built and stored in the memory is generated sequentially.

For signals generated with DDS technology, a single signal period is stored in the memory, but only certain samples are generated to create the waveform and the required frequency, as shown in the illustration below:

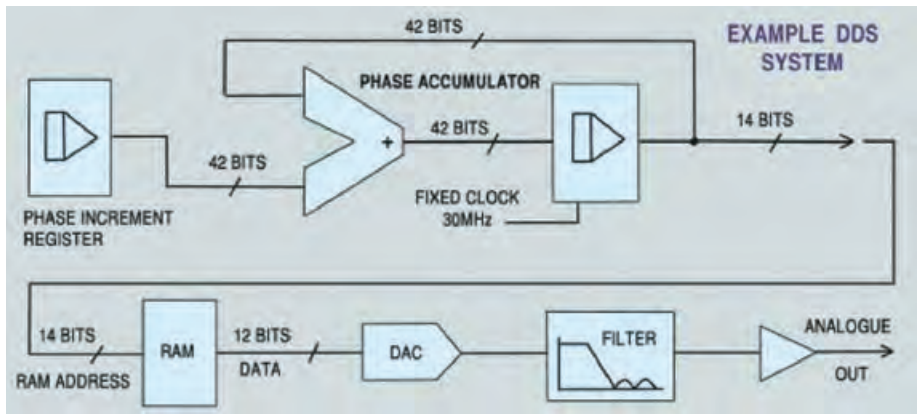

Direct Digital Synthesis (DDS) function generator

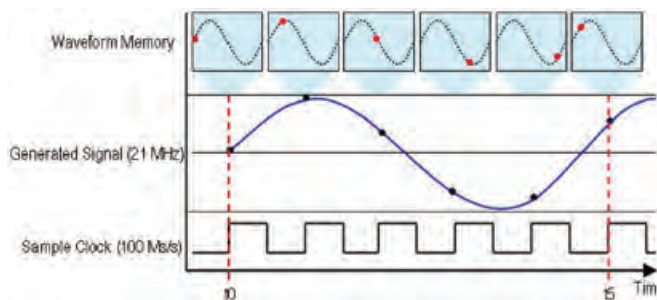

Generation of a 21 MHz signal with direct digital synthesis (DDS)

A FEW DEFINITIONS

Signal waveforms

The generator can typically generate sine, triangle and square waveforms, as well as their usual derivatives.

Frequency range (expressed in Hertz (Hz))

This is the difference between the minimum frequency and maximum frequency that the generator is capable of producing. This frequency range is defined for a sinusoidal waveform. It should be noted that a smaller frequency range is usually specified for triangular or square waveforms. The minimum frequency, which may be just a few mHz, is used to simulate slow phenomena (mechanical or physical) or to control slaving (for example, a triangular ramp profile).

Resolution

This is the smallest measurable value difference.

It is expressed in digits and its absolute value depends on the frequency range used. For the GX320, for example: 5-digit resolution at 20 MHz corresponds to a 1 kHz increment.

Frequency accuracy

This corresponds to the difference between the true value of the signal's frequency and the value displayed. It mainly depends on the quality of the oscillator used, for which short-term and long-term stabilities are defined, expressed in ppm (parts per million). For example, for the GX320: +/- 20ppm when F > 10 kHz.

SWEEP function

The "SWEEP" function can be used to generate a frequency sweep in rising or falling mode. This sweep can be controlled by the generator according to a linear or logarithmic law or on the basis of an external sawtooth or triangular signal applied via a dedicated BNC connection.

Types of modulation

AM: Amplitude Modulation

FM: Frequency Modulation

FSK function: Frequency SKip controlled internally or externally.

PSK function: "Phase SKip" whose value is controlled by an internal or external command signal.

BURST function

Affichage	Description	
20% AM FM	Affectation de l'amplitude de 20%	
80% AM FM	Affectation de l'amplitude de 80%	
AM FM	Affectation de fréquence	

The BURST function can be used to generate pulse trains: users define the train generation period and the number of pulses in the train.

It also provides a means of generating a signal with a very large duty cycle (1 brief pulse with a long repetition period).

GATE function

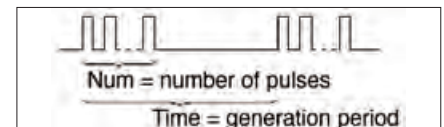

This superimposes over the active function a start/stop command for the AC component of the MAIN OUT signal.

This function can be controlled internally or by a TTL signal injected on a dedicated BNC connection.

MASTER/SLAVE function



This can be used to synchronize several GX 320s set up in a "cascade" arrangement. The generator used as the "Master" supplies the other "Slave" instruments with the clock (Clk) and a synchronization signal (Ctrl). This enables all the generators to start up at the same time and allows users to control their phase shift.

SELECTION GUIDE

FUNCTION GENERATORS



SPECIFICATIONS

	GX305	GX310	GX320
Number of channels	1	1	1
Max. frequency (MHz)	5	10	20
Display	LCD (125 x 45 mm) - 5 digit		
Signal waveforms	Sine, triangle, square & logic+TTL		
Sweep	•	•	•
AM/FM modulation			•
FSK/ASK function			•
BURST function			•
GATE function			•
MASTER/SLAVE function			•
Frequency meter		100 MHz	
Pages		202-203	

ARBITRARY FUNCTION GENERATORS



SPECIFICATIONS

	GX1025	GX1050	DOX3104 - DOX3304
Number of channels	2	2	1
Max. frequency (MHz)	25	50	25
Display	3.5" colour TFT		8"
Signal waveforms	Sine, triangle, square, ramp, pulse, white noise, Arb		
Sweep	•	•	
Modulation AM/FM	•	•	
FSK/ASK function	•	•	
BURST function	•	•	
GATE function	•	•	
MASTER/SLAVE function			
Frequency meter		200 MHz	
Arbitrary function	•	•	•
SX-GENE software	•	•	
EasyWave software			•
Pages		204-205	184-185

GX305, GX310 & GX320



Multi-function, stand-alone, innovative laboratory generators/meters!

Ergonomics: uniquely easy to read!
 The GX generators have a large LCD screen (125 x 45 mm) offering exceptionally easy reading thanks to the main display's 5 digits 20 mm high. In addition, the GX generators can simultaneously display all the parameter settings (V_{dc}, V_{RMS} or V_{PP}, waveform, etc.).



★ STRENGTHS

- Frequency range from 0.001 Hz to 10 MHz (GX310) or 20 MHz (GX320)
- DDS technology with a frequency accuracy of +/-20 ppm
- Adjustment of stable frequency to the nearest digit
- "Logic signal" function for direct adjustment of the high and low levels (TTL, CMOS, etc.)
- 100 MHz frequency meter, 300V CAT I
- Versions programmable via USB link with the standard SCPI protocol
- AM/FM modulation (GX320)
- GATE, BURST, FSK and PSK functions (GX320)
- Storage of 15 complete instrument configurations (GX320)

Specific innovative function:

Adjustable-phase synchronisation of several generators in a cascade arrangement (GX320).

Synchronization of several generators in a cascade arrangement

The "SYNC" function on the GX 320 allows several generators to be set up in a cascade arrangement to make a variable-phase multiple-signal generator. A first GX 320, used as the "Master", provides the other "Slave" instruments with the clock used to generate the signals. It also supplies the synchronizing pulse to start all the instruments simultaneously. In this way, the phase shift of each signal is controlled.

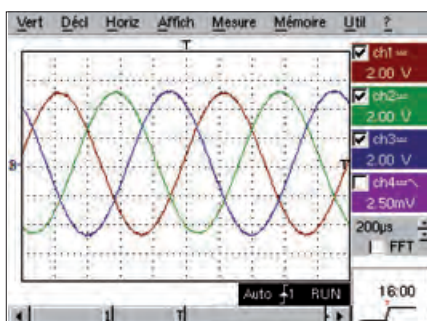
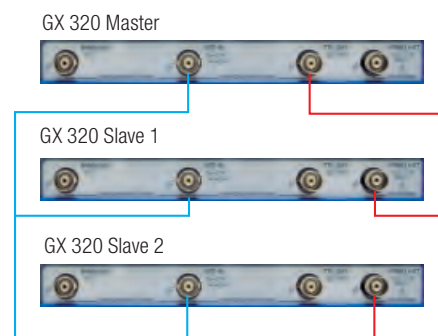

Example 1: simulation of a three-phase signal

- Channel 1: master (0°)
- Channel 2: slave1 (120°)
- Channel 3: slave2 (-120°)

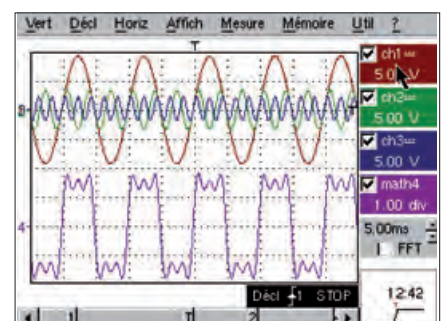

Example 2: Fourier synthesis

Synchronization of the generators (3 in this example) allows simulated synthesis of a square signal from its primary harmonics.

SPECIFICATIONS

	CX 305 / GX 310	GX 320
Human-machine interface		
Display	LCD (125 x 45 mm) – Adjustable brightness – Frequency display with 5 digits 20 mm high	
Adjustment of signal parameters	Continuous adjustment by encoder, auto-ranging for Frequency and Level, selection of increment digit (F, P, N, etc.)	
BNC output terminals on front panel	TTL & Sweep Out outputs	TTL, Sweep, Clock and Synchro outputs
BNC input terminals on front panel	VCF In input	VCG, Gate, Clock and Synchro inputs
Continuous signal generation		
Frequency	0.001 Hz to 10.000 MHz (9 ranges - GX 305) 0.001 Hz to 10.000 MHz (10 ranges - GX 310)	0.001 Hz to 20.000 MHz (11 ranges)
Resolution / accuracy	5-digit display – resolution from 1 mHz to 1 kHz depending on range / 10 kHz, ± 30 ppm for F < 10 kHz	
Amplitude	1 mV to 20.0 V _{PP} with open circuit in 3 automatic ranges – 3-digit display V _{PP} or V _{RMS} – Max. resolution 1 mV	
Accuracy of level (Flatness)	<< 5 % for 1 mHz < F < 10 MHz, and ± 0.5 dB typ. up to 20 MHz (GX 320) (specs for a level from 0.1 V _{PP} to 20 V _{PP})	
Signal waveforms	Sine / Triangle (max. frequency 2 MHz) / Square & "LOGIC" / TTL output	
Frequency sweep		
Modes	LIN (linear) or LOG (logarithmic)	
INT internal sweep	"Sawtooth" or "Triangle" mode – Unlimited span between "F Start" & "F Stop" Sweep time adjustable from 10 ms to 100 s	
EXT external sweep	Sweep by signal < 15 kHz, amplitude ± 10 V	
Modulation		
Internal AM modulation	Modulation by a 1 kHz sine signal Modulation rate 20 % or 80 %	
External AM modulation	Modulation by a signal < 5 kHz, with amplitude ± 10 V for 0 to 100 % modulation (VCG IN)	
Internal FM modulation	Modulation by a 1 kHz sine signal Unlimited span between "F Start" & "F Stop"	
External FM modulation	Modulation by a signal < 15 kHz Amplitude ± 10 V (VCG IN)	
SHIFT K function	Frequency hop, internal or external phase jump	
Burst function		
Internal BURST	1 to 65,535 pulses Period of pulse trains 10 ms to 100 s	
External BURST	1 to 65,535 pulses – Synchro/Period by a TTL signal with frequency < 1 MHz (VCG IN)	
GATE function	Validation of AC component from "Main Out" by a TTL signal with frequency < 2 MHz (GATE IN)	
Synchro function		
Cascade configuration of several GX 320s	Maximum frequency of generated signals 100 kHz Adjustment of phase shift to ± 180° (resolution 1°)	
External frequency meter		
Measurement range / accuracy	5 Hz to 100 MHz / ± 0.05 % + 1 digit	
Safety / max. admissible voltage	300 V CAT I / 300 V _{RMS}	
General specifications		
Configuration memories	Storage/Recall of 15 complete instrument configurations	
Communication interface	"USB A/B" link for the programmable versions (P) and Ethernet for the GX 320-E	
Mains power supply	230 V ± 10 % (or 115 V ± 10 %) – 50/60 Hz – 20 VA max. – Removable lead	
Safety / EMC	Safety as per IEC 61010-1 (2001) – EMC as per EN 61326-1 (2004)	
Mechanical specifications	227 (L) x 116 (H) x 180 (W) mm / weight 2.8 kg	
Warranty	3 years	

CONTENTS

Standard versions

– 1 function generator, 1 mains power cable, 1 CD-Rom containing: 1 user's manual in 5 languages, 1 programming manual in FR + EN, LabWindows CVI / LabView drivers

Programmable versions

– -P version: 1 function generator, 1 mains power cable, 1 CD-Rom containing: 1 user's manual in 5 languages, 1 programming manual in FR + EN, LabWindows CVI / LabView drivers, 1 USB A/B cable - Ethernet version
– -E version: The same + 1 Ethernet cable

ACCESSORIES

Set of 2 BNC-BNC cables 1 m long **HX0106**

Set of 2 BNC-banana adapters **HX0107**

See page 212

TO ORDER

5 MHz function generator **GX305**

10 MHz function generator **GX310**

Programmable 10 MHz function generator **GX310-P**

20 MHz function generator **GX320**

Programmable 20 MHz function generator **GX320-E**

GX1025 & GX1050



GX 1025, 25 MHz



GX 1050, 50 MHz



GX 1050 (rear view)



These multi-function, communicating laboratory generators-meters with built-in frequency meter are ideal for all R&D lab, testing and production applications, as well as for technical training and higher education.

★ STRENGTHS

- Large 320 x 240 mm TFT LCD screen with high contrast for better visibility, intuitive front panel and simple use
- DDS technology on 2 outputs for coupling or duplication
- Generation of standard signals such as sine, square and triangle, as well as more complex signals: pulse, ramp or white noise
- Generation of arbitrary signals which are precise, stable and pure, with low distortion at a sampling rate of 125 MS/s on 14-bit resolution
- Internal SWEEP wobble modulation: external or manual, linear or logarithmic
- The integrated AM, FM, PM, ASK and FSK modulation functions can be used to generate modulated signals very easily without an independent modulation source
- Memory depth of up to 16 kpoints, allowing reconstruction or simulation of any type of complex signal
- Generator user interface and integrated help in English
- USB interface on front panel for data storage
- USB interface on front panel for programming and control of the instrument via the SX-GENE software

SX-GENE v2.0 can be used to control a GX 1025 or GX 1050 arbitrary function generator, save and recall configurations and generate arbitrary signals.

★ STRENGTHS

It allows:

- Data transfer in .arb files (from the generator to the PC)
- Recovery of a signal from a METRIX® oscilloscope curve (.trc file transferred into the generator)
- Configuration of the generator (.cfg)
- Recovery of an arbitrary signal stored in one of the generator's 10 memory locations

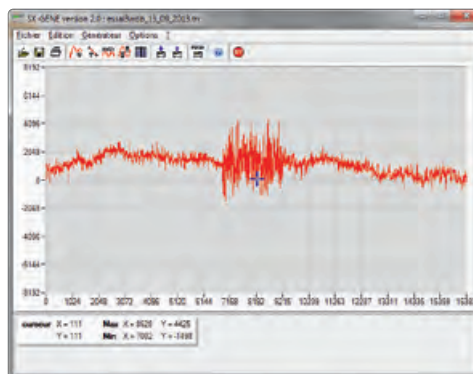

📁 CONTENTS

1 GX delivered with 1 mains power cable, 1 USB cable, 1 user manual, 1 programming manual on CD-Rom and the SX-GENE v2.0 software

SPECIFICATIONS

	GX 1025	GX 1050
Human-machine interface		
Display	Large high-contrast 3.5" TFT colour screen / Resolution 320 x 240	
Front panel commands	18 direct-access buttons, 1 rotary button	
Adjustment of signal parameters	Continuous adjustment by the encoder and/or numeric keypad	
BNC output terminals on front panel	Generator outputs 1 & 2 - Separate adjustment (waveform, f, phase, amplitude, etc.), coupled or duplicated	
BNC I/O terminals on rear panel	TTL-compatible trigger and synchronization outputs	
Continuous signal generation		
Signal types	Sine, Square, Triangle, Ramp, Pulse, White Noise, Arbitrary Signal (48 pre-installed waveforms)	
Arbitrary signal generation		
Resolution / sampling	14 bits / 125 MS/s	
Data storage	16k memory depth (512k on CH1 only) - Storage of predefined or specific signals on USB key	
Signal editing with SX-GENE	Acquisition, transfer & modification of a signal acquired from an oscilloscope (OX6000, OX7000, SCOPEin@BOX) Graphical or mathematical editing with the SX-GENE software	
Signal frequency		
Frequency range	Sine from 0.001 MHz to 25.000 MHz Triangle 300 kHz, Noise and Square 25 MHz, Pulse 10 MHz, Arbitrary Signals 5 MHz	Sine from 0.001 MHz to 50.000 MHz, Triangle 300 kHz, Noise and Square 50 MHz, Pulse 20 MHz, Arbitrary Signals 5 MHz
Resolution / accuracy	7-digit display – resolution from 1 mHz to 1 kHz depending on frequency range ± 20 ppm for $F > 10$ kHz, ± 30 ppm for $F < 10$ kHz	
Long-term drift	± 100 ppm / year	
Temperature coefficient	< 5 ppm / °C	
Amplitude		
Voltage level	Output 1 = 2 mV _{PP} ~ 10 V _{PP} 50 Ω 2 mV _{PP} ~ 20 V _{PP} (open circuit) Output 2 = 2 mV _{PP} ~ 3 V _{PP} 50 Ω 2 mV _{PP} ~ 6 V _{PP} (open circuit)	
Level accuracy (Flatness)	< 0.1 dB for $f < 100$ kHz	
V _{DC} offset	Output 1 = ± 10 V _{DC} (open circuit), Output 2 = ± 3 V _{DC} (open circuit) – Accuracy $\pm 1\%$ ± 1 mV	
Impedance / protection	50 Ω / Protection against short-circuits	
Signal characteristics		
Sine	Distortion $< 0.2\%$ typical for $f < 20$ kHz, and harmonics < -50 dBc for DC $< f < 25$ MHz (level < 1 V _{PP})	
Triangle (max. frequency 2 MHz)	Linearity error $< 1\%$ max.	
Square & pulse	Rise time < 12 ns (typ.) – Duty cycle 20-80% (DC $< f < 20$ MHz) – Pulse 20 ns to 2,000 s	
Modulations (internal or external source)		
AM modulation	Carrier: Sine, Square, Triangle, Arbitrary (except DC) modulation Modulated signals: Sine, Square, Ramp, Noise, Arbitrary (2 mHz-20 kHz) Modulation depth: 0% to 120%	
FM modulation	Carrier: Sine, Square, Triangle, Arbitrary (except DC) Modulated signals: Sine, Square, Ramp, Noise, Arbitrary (2 mHz-20 kHz) Modulation depth: 0% to 120%	
	Frequency offset 0 to 12,5 MHz	Frequency offset 0 to 25 MHz
FSK modulation	Carrier: Sine, Square, Triangle, Arbitrary (except DC) Modulated signals: 50% of duty cycle (2 mHz to 50 kHz)	
ASK modulation	Carrier: Sine, Square, Triangle, Arbitrary (except DC) Modulated signals: 50% of duty cycle (2 mHz to 50 kHz)	
PM modulation	P Carrier: Sine, Square, Triangle, Arbitrary (except DC) Modulated signals: Sine, Square, Ramp, Triangle, Noise, Arbitrary (2 mHz-20 kHz) Phase shift: 0 to 360°	
Other functions		
Sweep	Carrier: Sine, Square, Ramp, Triangle, Arbitrary (except DC) - Type: Linear/Logarithmic Direction: Increasing or Decreasing - Sweep time: 1 ms to 500 s - Trigger: Manual, External, Internal	
Burst	Signals: Sine, Square, Ramp, Arbitrary (except DC) - Type: Short (1-50,000 cycles), Infinite, Gate - Phase start/stop: -180° to +180° - Internal period: 1 μs to 500 s $\pm 1\%$	
External frequency meter		
Measurement range / resolution	100 mHz to 200 MHz	
Sensitivity / input impedance	20 mV _{RMS} for 100 mHz $< f < 100$ MHz, 40 mV _{RMS} beyond / 1 MΩ	
General specifications		
Data storage	Storage of predefined or specific signals and complete instrument configurations on USB key	
Communication interface	USB Device, USB host	
Software	The SX-GENE software can be downloaded free of charge from our support website, along with the LV and LW drivers	
Mains power supply	100~240 V _{ACRMS} 45~440 Hz CAT II - < 30 W	
Mechanical specifications	229 x 105 x 281 mm – 2.8 kg	
Warranty	2 years	

TO ORDER

25 MHz arbitrary function generator	GX1025
50 MHz arbitrary function generator	GX1050

ACCESSORIES

See page 217

AX501, AX502, AX503 & AX503F



As well as being particularly rugged, these power supplies are also lightweight, economical and based on the latest technology!

The AX 501, AX 502 and AX 503 laboratory power supplies with 1, 2 or 3 outputs offer electronic limitation of the current in the event of short-circuit and temperature control in the event of overload or overheating. Their linear technology is based on a toroidal transformer which halves their weight and improves their efficiency.

★ STRENGTHS

- Linear technology: stability, low noise, good response to current demand
- Active protection against short-circuits, overloads and overheating
- Outputs with double insulation in relation to the mains
- Series or parallel output coupling for generating up to 60 V / 2.5 A or 30 V / 5 A
- Coupling of the two 30 V outputs in "tracking" mode in order to adjust them simultaneously (master/slave)
- Adjustable current limitation on the 30V outputs
- A third adjustable 2.7 V-5.5 V/5 A output on the AX 503 can be used to power logic circuits (TTL/ CMOS)
- Compact and lightweight
- Dual-well safety terminals
- An earth terminal with reversed polarity to avoid connection errors



⚙️ SPECIFICATIONS

	AX501	AX502	AX503	AX503F
Technology	Linear			
Display	LEDs – green and red- 3 digits			
Outputs	1 x (30 V/2.5 A)	2 x (30 V/2.5 A)	2 x (30 V/2.5 A) 1 x (2.7 to 5.5 V/5 A)	2 x (30 Vdc/ 2.5 A fixed 3.3 Vdc fixed/5 A fixed)
Coupling of outputs	Series or parallel			
Output tracking	Yes ("track" mode)			
Special features	Electronic protection against short-circuits, overloads and overheating. Output double insulated from mains Toroidal transformers (no forced ventilation and low emissions) Double-well safety terminals			
Power supply	115 V* / 230 V			
Dimensions (H x L x W)	120 x 225 x 270 mm			
Weight	4 kg	4.5 kg		6 kg
Warranty	3 years			

⚙️ SPECIFIC ACCESSORIES

Reverse-polarity earthing cable (green/yellow)	P01295073A
--	------------

⚙️ ACCESSORIES

See page 211

🛒 TO ORDER

AX 501	AX0501A
AX 502	AX0502A
AX 503	AX0503A
AX 503F	AX0503F

📦 "STANDARD" CONTENTS

1 AX, 1 power cable, 1 user's manual

AX1360-P



Performance and simplicity at the best price!

STRENGTHS

- 2 adjustable outputs (0-30 V) and 1 selectable fixed output (2.5 V / 3.3 V / 5 V)
- Bright colour display of the currents and voltages simultaneously on 3 digits
- Simplified use thanks to serial or parallel coupling without leads
- Quicker setup with 4 configurations available for recall on the front panel
- High stability and low drift over time, whatever the mode
- Protection against voltage surges, overheating and short-circuits
- Ventilation control according to the output power
- USB communication

SPECIFICATIONS

		AX 1360-P	
Frequency			
Display	Digital with LEDs – Simultaneous voltage and current in colour		
Number of outputs	3		
Voltage control			
Output 1	0 – 30 V		
Output 2	0 – 30 V		
Output 3	2.5 V / 3.3 V / 5 V		
Current control	Independent	Parallel	
Output 1	3 A	6 A	
Output 2	3 A	6 A	
Output 3	3 A	-	
Accuracy			
Voltage	±(0.5 % of reading + 2 digits)		
Current	±(0.5 % of reading + 5 digits)		
Resolution			
Voltage	10 mV (0 to 9.99 V) – 100 mV (10 to 30 V)		
Current	10 mA		
Ripple and noise			
Voltage	< 1 mV _{RMS}		
Temperature coefficient			
Voltage	< 300 ppm / °C		
On-load	Independent and in parallel		
Voltage control	< 0.1 % +5 mV		
Current control	< 0.2 % +3 mA		
Protection			
Short-circuits	Current limitation and visual indication by red LED		
Overcurrent	Fuse		
"SAVE/RECALL" function			
Number of stored configurations	4		
Technical specifications			
Current and voltage adjustment	Outputs 1 and 2 by potentiometers, Output 3 by switch		
Interface / software	USB / LV and LW drivers		
Mains power supply	220 V / 50 Hz – 60 Hz		
Safety / protection	Dimensions : 310 x 250 x 150 mm / weight: 7.5 kg		
Mechanical specifications	4		
Warranty	2 years		

"STANDARD" CONTENTS

AX1360-P: 1 programmable power supply, 1 power cable, 1 USB cable, 1 CD-Rom containing the user's manual and the LabView drivers

ACCESSORIES

See page 217

TO ORDER

AX 1360P programmable power supply

AX1360-P

CX 1651 & CX 1652



Designed for calibrating measuring instruments, the calibrators from Metrix are particularly accurate and stable.

★ STRENGTHS

Based on a new concept, they generate:

- standard electrical parameters for temperature or energy applications
- non-harmonic signals for testing equipment when the distortion on the input signals is non-null.

Ils permettent la calibration de multiples instruments :

- Multimeters
- Analogue instruments
- Switchboard equipment
- Current clamps
- Portable calibrators
- Wattmeters
- Electrometers
- Oscilloscopes
- Thermometers
- Loggers, etc.



CX 1652 for simple checking of a current clamp.



Calibrate your current sensors, temperature sensors, etc.



SPECIFICATIONS

			CX1651	CX1652
Best accuracy*				
Voltage	DC	6 ranges from 0 to 1,000 V	0.003 %R + 16 μV	0.0015 %R + 8 μV
	AC	6 ranges from 0 to 1,000 V	0.025 %R + 100 μV	0.018 %R + 100 μV
Current	DC	6 ranges from 0 to 20 A (CX1651)	0.01 %R + 60 μA	0.01 %R + 0.6 μA
		6 ranges from 0 to 30 A (CX1652)		
	AC	6 ranges from 0 to 20 A (CX1651)	0.05 %R + 100 μA	0.05 %R + 1 μA
		6 ranges from 0 to 30 A (CX1652)		
Resistance	4-wire configuration	10 ranges from 0 Ω to 50 MΩ (CX1651)	0.015 %R	0.01 %R
		16 ranges from 0 Ω to 1GΩ (CX1652)		
Capacitance		9 ranges from 0.9 nF to 50 μF (CX1651)	0.5 %R	0.5 %R
		10 ranges from 0.7 nF to 100 μF (CX1652)		
Frequency	Square wave, duty cycle and amplitude calibrated	0.1 Hz to 20 MHz	0.005 %R	0.005 %R
Power		0.0004 to 2.4 kVA (CX1651)	Depends on the voltage, current and time values	
Energy		0.0004 to 4.8 kVA (CX1652)	The best uncertainty is 0.016 % for DC and 0.07 % for AC	
Temperature	Thermocouple	K, N, R, S, B, J, T, E from -250 to +1,820 °C	0,4 °C	0,4 °C
	Resistance sensor	Pt100, Pt200, Pt1000, Ni100 from -200 °C to 850 °C	0,1 °C	0,1 °C

* Depending on measurement range. Please refer to the user's manual for further details.

MULTIMETER

Function	CX1651		CX1652	
	Range	Accuracy	Range	Accuracy
V _{DC} (DC voltage)	0 - ±12 V	0.01 % + 300 μV	0 to ±20 V	0.01 % + 500 μV
mV _{DC} (DC voltage)	0 - ±2,000 mV	0.2 % + 7 μV	0 to ±2 V	0.02 % + 7 μV
mA _{DC} (DC current)	0 - ±25 mA	0.02 % + 1 μA	0 to ±25 mA	0.015 % + 300 nA
FREQ (Frequency)	1 Hz - 15 kHz	0.005 %	1 Hz to 15 kHz	0.005 %
R4W (Resistance)	0 - 2 kΩ	0.02 % + 100 mΩ	0 to 2.5 kΩ	0.02 % + 10 mΩ
TRTD (RTD sensors)	-150 °C - +600 °C	0.1 °C	-200 to +850 °C*	0.1 °C
TTC (TC sensors)	-250 °C - +1,820 °C	0.4 to 2.5 °C	-250 to +1,820 °C	0.4 to 2.5 °C
SGS (Deformation)	Depending on sensor	0.01 % + 10 μV + sensor accuracy		

* Measurement current 1 mA.

"STANDARD" CONTENTS

CX1651 : 1 multifunction calibrator delivered with 1,000 V / 20 A test cables (x 2), 1 Option 40 cable adapter (Canon 25/2 x banana cable adapter, 1 m), 1 Option 60 cable adapter (Canon 25/4 x banana cable adapter, 1 m), 1 Option 70 cable adapter (adapter for resistances on four terminals), 1 RS 232 cable, 1 power cable, 2 spare fuses, 1 test report and 1 user's manual.

CX1652 : 1 multifunction calibrator delivered with 1 mains power cable, 1 user's manual (CD), 2 x red/black 1,000 V / 20 A test cables 1 m long, 1 SUB-D25 / 2 x banana adapter cable 1 m long (DC voltage/current), 1 SUB-D25 / 4 x banana adapter cable 1 m long (4-wire resistance), 1 SUB-D25 / 4 x banana adapter cable 1 m long (4-wire resistance simulation), SUB-D25 / 2 x banana adapter cable 1 m long (mV_{DC} and TC), spare fuse(s), 1 RS232 cable 1 m long, 1 test report.



ACCESSORIES

See page 217

TO ORDER

CX 1651 multifunction calibrator	CX1651
CX 1652 multifunction calibrator	CX1652

TRAINING BOXES AND SHUNTS



★ STRENGTHS

- IEC61010-1 -150V CAT II, 50V CAT III
- Selection by rotary switch



Simple resistance boxes

P03197521A	0,1 to 1 Ω
P03197522A	1 to 10 Ω
P03197523A	10 to 100 Ω
P03197524A	100 to 1,000 Ω
P03197525A	1 to 10 k Ω
P03197526A	10 to 100 k Ω
P03197527A	100 to 1,000 k Ω
P03197528A	1 to 10 M Ω

4, 5 and 7-decade resistance boxes

P01197401	BR 04: 4 decades, 1 Ω to 10 k Ω
P01197402	BR 05: 5 decades, 1 Ω to 10 k Ω
P01197404	BR 07: 7 decades, 1 Ω to 10 k Ω

Coupling jumpers

P01101892A	19 mm spacing - \varnothing 4 mm - 36 A
------------	---



Inductance box

P01197451	BL 07: 7 decades, 1 μ H to 10 H
-----------	-------------------------------------

Measurement shunts

	Max. current	Voltage drop
HA030-1 (class 0.5 as per IEC 61010-1 600 V CAT III)	30 A	300 mV

CHOOSE YOUR VOLTAGE PROBE



There are multiple criteria for choosing a probe. The approach below helps to specify your requirements and guide you naturally towards the most suitable model for your application.

To choose the probe to adapt to your oscilloscope, we advise you to follow the logic below:

Measurement input

- Max. AC voltage measurement and choice of installation category: CAT II or III? Attenuating probe or differential probe?
- Choice of attenuation: 1/10, 1/100 or 1/1,000 or 1/20, 1/200? Bandwidth according to the oscilloscope?
- Measurement input impedance

Output – Connections

- BNC or PROBIX?

Specific features

- What are your other criteria? Capacitance, rise time, safety, power supply, etc.?



SPECIFICATIONS

	Voltage probes				
CAT II voltage probes		•			
High-voltage probe			•		
CAT II 300V voltage probes				•	
PROBIX probes for SCOPIX					•
Differential probes					•
Pages	212	213	213	192	214

CHOOSE YOUR ISOLATED CURRENT PROBE

	Current probes		
Measurement with AC/DC clamp	•		
Measurement with AC clamp		•	
Measurement with flexible AC clamp			•
Pages	216	215	215

	Connection and protection accessories		
BNC	•		
Protection and transport		•	
Fuses			•
Pages	217	218	219



HX0003, HX0004, HX0005, HX0006 & HX0108



★ STRENGTHS

- A family of 5 products to cover all types of requirements
- Attenuation ratio of 10 or 100 (depending on the model)
- Bandwidth from 150 MHz to 300 MHz
- EN61010 safety from 400 V CAT II to 1,000 V CAT III (depending on the model)
- Compensation range from 12 to 22 pF or from 12 to 25 pF (depending on the model)
- Connection accessories are available for the probes:
 - HX0007: hook-type wire-grip termination
 - HX0008: crocodile-type wire-grip termination
- Additional accessories are delivered with the HANDSCOPE HX0108 kit
- ISOPROBE III probe compliant with 600 V CAT III with 1/10 attenuation on a 500 MHz bandwidth + HX0107 BNC /BAN adapter



⚙️ SPECIFICATIONS

	HX0003	HX0004	HX0005	HX0006	HX0108
Attenuation	1:10	1:10	1:10	1:100	1:10
Bandwidth	150	250	450	300	500
Input impedance (MΩ)	10 ±1 %	10 ±1 %	10 ±1 %	100 ±1 %	10 ±1 %
Capacitance (pF)	14	14	< 14	≤ 6	12
Rise time (ns)	1,2	≤ 1,2	≤ 1	< 1	0,9
EN61010-2-031 safety	400 V CAT II	1 000 V CAT II	1 000 V CAT II	1 000 V CAT II	600 V CAT III
Compensation range (pF)	12 to 25	12 to 25	12 to 25	12 to 22	10 to 22
Retractable safety sleeve	Grey	Blue	Violet	Red	Grey



⚙️ ACCESSORIES (FOR HX000X)

Hook-type wire-grip termination	HX0007
Crocodile wire-grip termination	HX0008

🛒 TO ORDER

Compact probe, 10:1, 150 MHz	HX0003
Compact probe, 10:1, 250 MHz	HX0004
Compact probe, 10:1, 450 MHz	HX0005
Compact probe, 100:1, 300 MHz	HX0006
Measurement kit comprising one compact 10:1 probe, 500 MHz 600 V CAT III, and one BNC/Banana ø 4 mm adapter (HX0107)	HX0108

📦 "STANDARD" CONTENTS

HXxxxx: 1 probe, 1 reference cable, 1 user's manual

HX0027



★ STRENGTHS

- Design mounted on a patented ceramic support, with the elements adjusted by laser
- Interchangeable spring-mounted tip
- 1/1,000 probe with 30 MHz bandwidth
- This 14kV high-voltage probe can be used in various Category II sectors

HX0206, HX0210 & HX0220



★ STRENGTHS

- A family of 3 products to meet the various requirements
- A switchable attenuation of 1:1 or 10:1
- Bandwidth from 60 MHz, 100 MHz or 200 MHz depending on the model

⚙️ SPECIFICATIONS

	HX0027	HX0206	HX0210	HX0220
Attenuation	1 :1000	1 :1	1 :10	1 :1
Bandwidth	30	15	60	15
Input impedance (MΩ)	100+-1 %	1	10	1
Capacitance (pF)	< 2.5	45	15	46
Rise time (ns)	< 12	23	6	23
EN61010-2-031 safety	14 kV max 40 kV _{PEAK}	300 V CAT II	300 V CAT II	300 V CAT II
Compensation range (pF)	10 to 50	-	10 to 50	-

📦 "STANDARD" CONTENTS

HX0027: 1 probe, 1 "hook" measurement termination, 1 crocodile clip, 1 screwdriver for adjustment, 1 user's manual, 1 hard case
 HX0206-HX0210-HX0220: 1 probe, 1 "hook" measurement termination, 1 crocodile measurement earth, 1 screwdriver for adjustment, 1 user's manual

MX 9030, MTX 1032-B & MTX 1032-C



Ideal accessories for analogue or digital oscilloscopes for viewing signals not referenced to the earth, the MTX 1032-B and MTX 1032-C are equipped with 2 differential channels. Powered by the mains supply, these probes can be used separately or hooked up to MTX Compact oscilloscopes. The MX 9030 probe is supplied in a stand-alone handheld casing powered by a battery.

★ STRENGTHS

- A family of 3 products to meet the various requirements
- 1 or 2 input channels, 30 MHz or 50 MHz bandwidth
- Extra-long banana or coaxial/banana measurement leads
- Supplied in a laboratory casing or handheld casing with wrist-strap

⚙️ SPECIFICATIONS

	MX 9030-Z	MX 1032-B	HX0210
Differential input voltage	±60 V or ±600 V		±40 V or ±400 V
Max. common-mode voltage		±600 V	
Attenuation / accuracy	1/20 and 1/200 / ±3 %		1/10 and 1/100 / ±3 %
Bandwidth	30 MHz	30 MHz	50 MHz
Rise time	11.7 ns	11.7 ns	7 ns
Output impedance		50 Ω	
Coaxial output voltage (max.)	±3 V with 1 MΩ load		±4 V with 1 MΩ load
Noise level		< 10 mV _{PP}	
General specifications			
Power supply	9 V battery		Mains: 230 V _{AC} ±10 % 50/60 Hz
Safety	IEC 61010-1 600 V CAT IV	IEC 61010-1 600 V CAT III	IEC 61010-1 600 V CAT II
Dimensions / weight	163 x 62 x 40 mm / 195 g (with battery)		270 x 250 x 63 mm / 1.2 kg

📦 "STANDARD" CONTENTS

MX9030-Z: 1 single-channel probe with output on BNC cable, 1 standard battery installed, 1 set of PVC banana leads 1.10 m long, 1 set of 2 industrial-grade crocodile clips, 1 user's manual

MTX1032-B: 1 x 2-channel probe in "MTX Pack" casing, 2 BNC cables 20 cm long, 2 sets of PVC banana leads 1.10 m long, 1 European mains power cable, 1 set of accessories for mounting the probe on the oscilloscope, 1 user's manual

MTX1032-C: 1 x 2-channel probe in "MTX Pack" casing, 2 BNC cables 20 cm long, 1 set of 2 BNC-banana cables 2 m long, 2 crocodile wire-grips for probes, 1 European mains power cable, 1 set of accessories for mounting the probe on the oscilloscope, 1 user's manual

⚙️ ACCESSORIES

See page 217

🛒 TO ORDER

1 x 30 MHz stand-alone differential probe	MX9030-Z
x 30 MHz differential probe with banana inputs	MTX1032-B
2 x 50 MHz differential probe with coaxial inputs	MTX1032-C

AC CURRENT PROBES



SPECIFICATIONS

	MN 60	Y7N	C160	D38N
Measurement range	0.1 to 60 A _{PEAK} AC and 0.5 to 600 A _{PEAK} AC	1 A to 1,200 A _{PEAK}	0.1 to 2,000 A _{PEAK}	1 A to 5,000 A _{PEAK}
Transformation ratio	100 mV - 10 mV/A	1 mV / A	100 mV/A - 10 mV/A - 1 mV/A	10 mV/A - 1 mV/A - 0.1 mV/A
Bandwidth	40 Hz to 40 kHz	5 Hz to 10 kHz	10 Hz to 100 kHz	30 Hz to 50 kHz
Accuracy	≤ 2 % and ≤ 1.5 %	≤ 2 %	≤ 3 %, ≤ 2 %, ≤ 1 %	≤ 2 %
Clamping diameter	20 mm	30 mm	52 mm	64 mm
Output connector	BNC	BNC	BNC	BNC
Cable length	2 m	2 m	2 m	2 m
Dimensions	135 x 51 x 30 mm	195 x 66 x 34 mm	216 x 111 x 45 mm	305 x 120 x 48 mm
Weight	180 g	420 g	550 g	1 200 g
IEC 61010-2-32 safety	300 V CAT IV / 600 V CAT III			
Accessories supplied	1 user's manual			
To order	P01120409	P01120075	P01120308	P01120057A

FLEXIBLE CURRENT PROBES



SPECIFICATIONS

	MA200 30-300/3 - (17 CM)	MA200 30-300/3 - (25 CM)	MA200 3000/3 - (35 CM)
Measurement range	0.5 to 45 A _{PEAK} 0.5 to 450 A _{PEAK}	0.5 to 45 A _{PEAK} 0.5 to 450 A _{PEAK}	5 A to 4500 A _{PEAK}
Transformation ratio	100 mV/A - 10 mV/A	100 mV/A - 10 mV/A	1 mV/A
Bandwidth	5 Hz to 1 MHz	5 Hz to 1 MHz	2 Hz to 1 MHz
Accuracy	≤ 1 % + 0.3 A	≤ 1 % + 0.3 A	≤ 1 % + 0.3 A
Clamping diameter	45 mm	70 mm	100 mm
Output connector	BNC	BNC	BNC
Cable length	2 m + 40 cm	2 m + 40 cm	2 m + 40 cm
Dimensions	140 x 64 x 28 mm	140 x 64 x 28 mm	140 x 64 x 28 mm
Weight	200 g	200 g	200 g
Power supply	1 x 9 V	1 x 9 V	1 x 9 V
IEC 61010-2-32 safety	600 V CAT IV 1 000 V CAT III	600 V CAT IV 1 000 V CAT III	600 V CAT IV 1 000 V CAT III
Accessories supplied	9 V battery and user's manual		
To order	P01120570	P01120571	P01120572

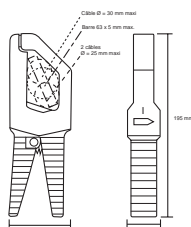

Y7N clamp

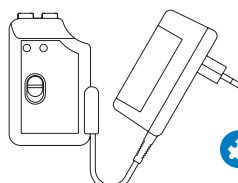

ACCESSORIES

Mains adapter for MA200

P01120287

AC/DC CURRENT PROBES



SPECIFICATIONS

	HX0102	E27	PAC17	PAC27
Measurement range	3 mA to 20 A _{AC/DC}	100 mA to 100 A _{AC/DC}	500 mA to 40 A _{AC} /60 A _{DC} 500 mA to 400 A _{AC} /600 A _{DC}	500 mA to 100 A _{AC} /140 A _{DC} 500 mA to 1,000 A _{AC} /1,400 A _{DC}
Transformation ratio	100 mV/A	100 mV/A - 10 mV/A	1 A / 10 mV - 1 A / 1 mV	1 A / 10 mV - 1 A / 1 mV
Bandwidth	DC to 60 kHz	DC to 100 kHz	DC to 30 kHz	DC to 30 kHz
Accuracy	< 1.5 %	≤ 3 % - ≤ 4 %	≤ 1.5 % - ≤ 2 %	≤ 1.5 % - ≤ 4 %
RMS analogue output	30 mA to 20 A _{AC/DC} 100 mV _{DC} /A	-	-	-
Clamping diameter	11.8 mm	11.8 mm	1 cable Ø 30 mm 2 cables Ø 24 mm	1 cable Ø 39 mm 2 cables Ø 25 mm 2 busbars 50 x 5 mm
Output connector	BNC	BNC	BNC	BNC
Cable length	2 m	2 m	2 m	2 m
Dimensions	231 x 67 x 36 mm	231 x 67 x 36 mm	224 x 97 x 44 mm	236,5 x 97 x 44 mm
Weight	330 g	330 g	440 g	520 g
Power supply	1 x 9 V	1 x 9 V	1 x 9 V	1 x 9 V
IEC 61010-2-32 safety		IEC 61010-2-032 - 300 V CAT IV / 600 V CAT III		
Accessories supplied		9 V battery and user's manual		
To order	HX0102 HX0102-K*	P01120027	P01120117	P01120127



SPECIFICATIONS

	MH60
Measurement range*	10 mA to 100 Arms or DC (140 A _{PEAK})
Transformation ratio	10 mV/A
Bandwidth	1 MHz
Switchable low-pass filters	None / 30 kHz / 3 kHz
10 to 90% rise time	350 ns
Clamping diameter	1 cable Ø 26 mm
Output connector	BNC
Cable length	2 m
Dimensions	138 x 49 x 28 mm
Weight	Approx. 200 g (with cable and rechargeable battery)
Power supply	Internal NiMh rechargeable battery (approx. battery life 8 hrs) or external 5 V _{DC} power supply via µUSB type B female connection
Safety	IEC 61010-1, IEC 61010-2-032, 300 V CAT III / 600 V CAT II
Accessories supplied	P01120612

*Frequency derating from 60 kHz

"STANDARD" CONTENTS

MH60 isolated AC and DC current probe for oscilloscopes, delivered with 1 100V-240 V 50/60 Hz mains adapter, 1 USB / µUSB power cable, 1 user's manual in 5 languages

ACCESSORIES

Mains adapter for E27, MH60, PAC17, PAC27	P01651023
1 x 110/240V 50/60 Hz mains power pack with female USB type A 5V 1A + 1 charging/connection cable 1.80m long, USB type A male/USB type Micro-B male	
NiMh rechargeable battery for MH60	P01296049Z

COAXIAL ACCESSORIES



Safety leads with 50 Ω impedance, length 1 m
IEC61010-2-031 - 600 V CAT III, black

> HX0106 (2 p)



Earth safety leads, length 2 m, 0 4 mm banana connection -
IEC 61010-2-031 Cat. III 1,000 V:
female banana plug / female, yellow/green (earth)

> P01295073A (5 p)



Set of 2 adapters
Insulated male BNC plug - insulated female plugs (R/B) Ø 4 mm with 19 mm spacing
600 V CAT III

> HX0107



Set of 2 adapters
Insulated female BNC - Insulated plugs (RIN) Ø 4 mm with 19 mm spacing - 600 V CAT III

> P01102101Z



Set of 2 adapters
Male BNC -insulated female sockets (R/B) Ø 4 mm with 19 mm spacing
500 V CAT I, 150 V CAT III

> P01101846



Set of 2 adapters
Male BNC -insulated male sockets (R/B) Ø 4 mm with 19 mm spacing
500 V CAT I, 150 V CAT III

> P01101847



Load adapter
50 Ω BNC additional load

> PA4119-50 (1 p)



Safety coupling jumper with 19 mm spacing - Ø 4 mm - 36 A -
IEC 61010-2-031:
Set of 10 black coupling jumpers

> P01101892A

Demonstration board for practical exercises, valid for all our oscilloscopes

> HX0074

PROTECTION AND TRANSPORT ACCESSORIES, MECHANICAL ADAPTATIONS



MTX-family bag for MTX 3240, MTX 3250, MTX 3252, MTX 3352 and MTX 3354 models. The mouse can be stored in the side pocket.

HX0024



Empty hard case for Scopix equipped with precut foam inserts for stowing documents and accessories (power supply, Probix accessories, communication cables, etc.).

HX0038



Protective hands-free bag for HANDSCOPE portable oscilloscopes (OX5022B and OX5042B)

HX0105



Battery for SCOPIX IV: 5.8AH LI-ION battery pack

P01296047

External charger for LI-ION battery

P01102130

SCOPIX IV bag comprising an all-terrain bag with waterproof bottom and shoulder strap (380x280x200 mm) and an internal compartmented bag for stowing the SCOPIX and its accessories

HX0120



Charger unit for 12 Vdc vehicle cigarette lighter

HX0061

FUSE SELECTION TABLE

Product concerned	Standardized dimensions	Amperage	Sales reference
MX0044HD	5 x 20	0.630 A	AT0096
MX0044HDL	5 x 20	0.630 A	AT0096
MX0056C	5 x 20	0.630 A	AT0096
MX0058HD	5 x 20	0.630 A	AT0096
MX0059HD	5 x 20	0.630 A	AT0096
MX0059HDL	5 x 20	0.630 A	AT0096
AX 501	5 x 20	6.3 A	AT0087
AX 502	5 x 20	6.3 A	AT0087
AX 503	5 x 20	6.3 A	AT0087
MTX 3250	6 x 32	10 A	AT0095
MTX 3281	10 x 38	11 A	P01297092
MTX 3282	10 x 38	11 A	P01297092
MTX 3283	10 x 38	11 A	P01297092
MTX203-Z	10X38	11A	P01297096
MTX203-Z	6.3x32	0.63A	P01297098
MTX204-Z	10X38	10A	P01297096
MTX204-Z	6.3x32	0.63A	P01297098
MTX3290	6.3X32	10A	P01297038
MTX3291	10x38	11A	P01297092
MTX3292B	10X38	11A	P01297092
MTX3293B	10X38	11A	P01297092
MX 1	6 x 32	10 A	AT0070
MX 1	6 x 32	1.6 A	AT0071
MX 20	5 x 20	0.63 A	AT0094
MX 20	8 x 32	10 A	AT0055
MX 20HD	5 x 20	0.63 A	AT0094
MX 20HD	6 x 32	10 A	AT0095
MX 22	6 x 32	10 A	AT0095
MX 22	6 x 32	0.63 A	AT0519
MX 23	6 x 32	10 A	AT0095
MX 24B	6 x 32	10 A	AT0095
MX 24B	6 x 32	0.63 A	AT0519
MX 26	6 x 32	10 A	AT0095
MX 26	6 x 32	0.63 A	AT0519
MX 409	6 x 32	0.200 A	P01297104
MX 44	5 x 20	0.63 A	AT0518
MX 44	6 x 32	10 A	AT0095
MX 44HD	5 x 20	0.63 A	AT0518
MX 44HD	6 x 32	10 A	AT0095
MX 51	5 x 20	0.63 A	AT0094
MX 51	8 x 32	10 A	AT0055
MX 52	5 x 20	0.63 A	AT0094
MX 52	8 x 32	10 A	AT0055
MX 53	5 x 20	0.63 A	AT0518
MX 53	6 x 32	10 A	AT0095
MX 54C	5 x 20	0.63 A	AT0518
MX 54C	6 x 32	10 A	AT0095
MX 553	6 x 32	10 A	AT0095
MX 556	6 x 32	10 A	AT0095
MX 55C	5 x 20	0.63 A	AT0518
MX 55C	6 x 32	10 A	AT0095
MX 56C	5 x 20	0.63 A	AT0518
MX 56C	6 x 32	10 A	AT0095
MX 57Ex	5 x 20	0.5 A	AT0057
MX 57Ex	6 x 32	1 A	AT0064
MX 58HD	10 x 38	11 A	P01297092
MX 58HD	5 x 20	0.63 A	AT0518
MX 59HD	10 x 38	11 A	P01297092
MX 59HD	5 x 20	0.63 A	AT0518
MX407	6 x 32	0.5 A	P01297097
MX5006	6X32	10A	AT0095
MX5060	6X32	10A	AT0095

BY FUNCTIONS

#

100 mV shunts	145
2P/3P earth	40 - 42 - 57 to 60
4P earth	58 to 60

A

AC current clamp	139 - 140
AC/DC current clamp	141
AC/DC current sensors	215
Accessories for oscilloscopes	192
Air flow rate	123
Air speed	123 - 126 - 127
Ambient air	128
Ammeter with flexible sensor	28
AmpFlex® flexible AC current sensors	142
Analogue multimeter	22
Audible continuity	17 to 22

B

Bag	154 - 218
Battery charge tester	72
Benchtop digital multimeter	170
Benchtop digital oscilloscope	182 - 184
Body temperature	111
Bus analyser	190

C

Cable	150
Cable and metal conductor locator	73
Cable detection	73
Capacitance	17
Capacitance boxes	145
Clamp multimeter	30 - 31
CO detector	127
CO ₂	127 - 128
CO ₂ , temperature & humidity logger	128
Conductivity meter	133
Contact thermometer	119 to 121
Continuity of protective earth conductors	43
Continuity tester	43
Current	17

D

Data processing software	74 - 102 - 130
Db	22
DDS function generator	202 to 204
Decibel	124
Dew point	113 - 122
Differential current probe	214
Digital insulation tester	51 to 54
Digital multimeter	24 to 26 - 164 to 169
Diode	17

E

Earth coupling	59 - 60
Earth measurement	36
Earth tester	57 to 62
Electric field tester	162
Electrical equipment tester	64 - 65
Electrical installation testing	34 - 40 to 43
Electrical measurement logger	95 - 97
Electrical testing & safety accessories	76 to 82
Electronic voltage sensor	212
Energy	88 to 97
Environmental measurement accessories	136
EV charging station analyser	44

F

Field meter	129
Flexible current sensor	215
Flicker	88 to 92
Frequency	22
Fuse	156 - 219

G

General-purpose probe	213
Graphical digital multimeter	26

H

Hand-cranked installation tester	46
Hand-cranked installation tester	46
Harmonics	27 - 30 - 31 - 40 - 84 to 97 - 147 - 187
High Voltage / High Frequency probe	213

I

Inductance boxes	145
Installation tester	40 to 42
Insulation	35 - 46 to 49
Isolated AC current sensors	215

L

Laboratory power supply	206
Laser tight	117 - 118
Leakage current	48 - 49 - 52 to 55
Leakage current clamp	55
LED voltage tester	161
Lighting	125
Loop impedance	40 - 42
Loop resistance	40 - 42
Luxmeter	125

M

Manometer	123
Measurement adapter for 2P+E socket	19
Micro-ohmmeter	69 - 70
Microwave	148
Microwave training benches	148
Motor rotation speed	87 - 124 - 126
Multifunction calibrator	208

N

No-contact thermometer	117 - 118
No-contact voltage detection	24

O

On-site analogue multimeter	161
On-site electrical safety tester	178 - 179
On-site insulation tester	51 to 54
Oscilloscope transport	218

P

pH/Temperature tester	131
Phase detection	16-17
Phase rotation	19 to 20
Phase rotation and/or motor tester	72
pH-meter	132
Pocket clamp multimeter	175 to 177
Portable oscilloscope	27 - 180 - 187 to 191
Power	27 - 30 - 31 - 40 - 64 - 86 to 92 - 95 to 97 - 147
Power & Harmonics training case	147
Power analyser	87
Power and energy accessories	103 to 105
Power and harmonics clamp	87

Process data logger	101
Process signal calibrator	110
Programmable power supply	207
Protection	154 - 218
Pt100	135
Pylon	60

R

Radiofrequency & microwave measurements	129
Ratiometer	71
RCD (tests)	40 - 42
Resistance	17 to 26
Resistance boxes	145
Resistive probe	109 - 135
Resistivity	58 to 62

S

Safety of machines	37
Safety of portable electrical equipment	37
Safety of switchboards	37
SMD tester	162
Soft case	154
Software for multimeters	171
Software for oscilloscopes	194 - 195
Solar power	93
Solar power analyser	93
Sound level meter	124
Spectrum analyser connected to a PC	198
Stray voltage detection	20
Stroboscope	127

T

Tachometer	126
Temperature	109 to 123
Temperature calibrator	109
Test adapter for electric vehicle AC charging stations	44
Test probe	151
Tester	15 - 17
Thermal camera	111
Thermo-anemometer	123
Thermocouple	109 - 119 - 134
Thermography	146
Thermography training bench	146
Thermo-hygrometer	122
Three-phase network and power analyser	88 - 91
Total dissolved solids (TDS)	133
Training case	146
Transients	88 to 92
TRMS current logger	98 - 99 - 101
TRMS voltage logger	100
Truelnrush	87

V

VD / VAT	19 - 20
Voltage Absence Tester (VAT)	18 to 20
Voltage detector (VD)	18 to 20
Voltage quality analyser	92

BY PRODUCT

A		
A110	142	
A130	142	
AX1360-P	207	
AX501	220	
AX502	220	
AX503	220	
AX503-F	220	
B		
B102	140	
BDH R100	222	
C		
C100	140	
C102	140	
C103	140	
C106	140	
C107	140	
C112	140	
C113	140	
C116	140	
C117	140	
C122	140	
C148	140	
C160	140	
C173	140	
CA 10001	131	
CA 10002	131	
CA 10101	132	
CA 10141	133	
CA 1110	125	
CA 1227	123	
CA 1246	122	
CA 1310	124	
CA 1510	128	
CA 1550	123	
CA 1621	109	
CA 1623	109	
CA 1631	110	
CA 1725	126	
CA 1727	126	
CA 1821	120	
CA 1822	120	
CA 1823	121	
CA 1860	117	
CA 1862	117	
CA 1864	117	
CA 1866	117	
CA 1871	118	
CA 1875	146	
CA 1900	111	
CA 1950	112	
CA 1954	113	
CA 40	129	
CA 5001	22	
CA 5003	22	
CA 5005	22	
CA 5011	22	
CA 5231	24	
CA 5233	24	
CA 5273	25	
CA 5275	25	
CA 5277	25	
CA 5292	26	
CA 5292BT	26	
CA 5293	26	
CA 5293BT	26	
CA 6011	43	
CA 6011 KIT	43	
CA 6113	40	
CA 6116N	40	
CA 6117	40	
CA 6131	42	
CA 6133	42	
CA 6161	64	
CA 6163	64	
CA 6165	65	
CA 6240	69	
CA 6255	69	
CA 6292	70	
CA 6416	62	
CA 6417	62	
CA 6418	62	
CA 6422	57	
CA 6424	57	
CA 6460	58	
CA 6462	58	
CA 6470N	59	
CA 6471	59	
CA 6472	60	
CA 6474	61	
CA 6501	46	
CA 6503	46	
CA 6505	52	
CA 6511	46	
CA 6513	46	
CA 6522	48	
CA 6524	48	
CA 6526	48	
CA 6528	47	
CA 6532	49	
CA 6534	49	
CA 6536	49	
CA 6541	51	
CA 6543	51	
CA 6545	52	
CA 6547	53	
CA 6549	53	
CA 6550	54	
CA 6555	54	
CA 6608	72	
CA 6609	72	
CA 6630	72	
CA 6651	44	
CA 6681	73	
CA 6710	223	
CA 702	24	
CA 7028	129	
CA 703	24	
CA 732	220	
CA 742	222	
CA 742 IP2X	222	
CA 745N	17	
CA 751	152	
CA 753	153	
CA 755	17	
CA 757	17	
CA 762	222	
CA 762 IP2X	222	
CA 771	223	
CA 771 IP2X	223	
CA 773	223	
CA 773 IP2X	223	
CA 8220	87	
CA 832	124	
CA 8331	88	
CA 8333	89	
CA 8336	90	
CA 8345	92	
CA 8436	91	
CA 847	122	
CA 850	123	
CA 876	118	
CA 895	127	
CA 922	27	
CA 942	27	
CDA 9452	127	
CX 1651	208	
CX 1652	222	
D		
D30CN	140	
D30N	140	
D31N	140	
D32N	140	
D33N	140	
D34N	140	
D35N	140	
D36N	140	
D37N	140	
D38N	140	
DATAVIEW®	74, 102, 130	
DL913	101	
DL914	101	
DOX 2025B	223	
DOX 2070B	223	
DOX 2100B	223	
DOX 3104	184	
DOX 3304	184	
DTR 8510	71	
E		
E25	141	
E27	141	
F		
F201	30	
F203	30	
F205	30	
F401	31	
F403	31	
F405	31	
F407	220	
F603	31	
F605	31	
F607	220	
F65	55	
FTV500	93	
G		
GX 1025	204	
GX 1050	204	
GX 305	202	
GX 310	202	
GX 320	202	
H		
HX0003	212	
HX0004	212	
HX0005	212	
HX0006	212	
HX0027	213	
HX0108	212	
HX0206	213	
HX0210	213	
HX0220	213	
K		
K1	141	
K2	141	
L		
L411	98	
L412	99	
L452	101	
L461	100	
M		
MA110	142	
MA130	142	
MA200	142	
MA4000D-350	28	
MA400D-170	28	
MA400D-250	28	
MH60	141	
MINI 01	139	
MINI 02	139	
MINI 03	139	
MINI 05	139	
MINI 09	139	
MINI102	139	
MINI103	139	
MN08	139	
MN09	139	
MN10	139	
MN11	139	
MN12	139	
MN13	139	
MN14	139	
MN15	139	
MN21	139	
MN23	139	
MN38	139	
MN39	139	
MN60	139	
MN71	139	
MN73	139	
MN88	139	
MN89	139	
MTX 1032-B	214	
MTX 1032-C	214	
MTX 1050	198	
MTX 3290	168	
MTX 3291	168	
MTX202	166	
MTX203	166	
MTX204	166	
MX 350	175	
MX 355	175	
MX 406B	179	
MX 5006	170	
MX 5060	170	
MX 531	178	
MX 604	179	
MX 650	176	
MX 655	176	
MX 670	177	
MX 675	177	
MX 9030	214	
MX1	161	
O		
OX 9302-BUS	190	
OX 9062	188	
OX 9102	188	
OX 9104	188	
OX 9304	188	
P		
PAC15	141	
PAC16	141	
PAC17	141	
PAC25	141	
PAC26	141	
PAC27	141	
PEL 106	97	
PEL102	96	
PEL103	96	
PEL104	96	
PEL51	95	
PEL52	95	
PROBIX	192	
PUISS-HARM	147	
S		
ScopeNet IV	194	
SX METRO	195	
SX-DMM	171	
T		
TCX 01	162	
TK 2000	119	
TK 2002	119	
TX01	161	
V		
VX0003	162	
VX0100	162	
Y		
Y1N	139	
Y2N	139	
Y3N	139	
Y4N	139	
Y7N	139	

BY REFERENCE

AG1066-Z.....	155	P01101847.....	155	P01102100Z.....	156	P01103073.....	82	P01120421.....	173
AT0094.....	81	P01101892A.....	147	P01102100Z.....	157	P01103076.....	94	P01120425B.....	98
AX1360-P.....	207	P01101892A.....	210	P01102101Z.....	155	P01103076.....	107	P01120425B.....	106
CX1651.....	209	P01101905.....	81	P01102103.....	80	P01103077.....	94	P01120434B.....	98
CX1652.....	209	P01101906A.....	81	P01102103.....	82	P01103077.....	107	P01120434B.....	106
DOX-MS03LA.....	185	P01101915.....	79	P01102106Z.....	155	P01103078.....	94	P01120439.....	42
DOX2025B.....	183	P01101915.....	82	P01102107Z.....	155	P01103078.....	107	P01120439.....	76
DOX2070B.....	183	P01101916.....	79	P01102112.....	81	P01103079.....	94	P01120439.....	81
DOX2100B.....	183	P01101916.....	82	P01102112.....	138	P01103079.....	107	P01120440.....	81
DOX3104.....	185	P01101917.....	79	P01102113.....	17	P01103080.....	27	P01120452.....	81
DOX3304.....	185	P01101917.....	82	P01102114Z.....	80	P01105101Z.....	141	P01120460.....	76
GX1025.....	205	P01101918.....	82	P01102114Z.....	82	P01105102Z.....	141	P01120470.....	80
GX1050.....	205	P01102182.....	79	P01102114Z.....	155	P01105102Z.....	173	P01120470.....	82
GX305.....	203	P01101919.....	79	P01102115.....	95	P01105103Z.....	141	P01120526B.....	106
GX310.....	203	P01101919.....	82	P01102117.....	107	P01105103Z.....	173	P01120531B.....	98
GX310-P.....	203	P01101921.....	76	P01102121Z.....	154	P01105105Z.....	141	P01120531B.....	106
GX320.....	203	P01101922.....	76	P01102123Z.....	154	P01105105Z.....	173	P01120550.....	78
GX320-E.....	203	P01101935.....	51	P01102124Z.....	154	P01105109Z.....	141	P01120550.....	82
HA030-1.....	210	P01101935.....	81	P01102125Z.....	154	P01105109Z.....	173	P01120551.....	78
HX0003.....	212	P01101941.....	81	P01102126Z.....	154	P01106102.....	141	P01120551.....	82
HX0004.....	212	P01101943.....	76	P01102127Z.....	154	P01106103.....	141	P01120552.....	98
HX0005.....	212	P01101959.....	98	P01102128Z.....	154	P01120001A.....	141	P01120552.....	99
HX0006.....	212	P01101959.....	106	P01102129.....	76	P01120005A.....	141	P01120554.....	106
HX0027.....	213	P01101959.....	107	P01102130.....	76	P01120025.....	143	P01120556B.....	98
HX0029B.....	26-172	P01101959.....	107	P01102130.....	94	P01120025.....	173	P01120568.....	98
HX0030C.....	192	P01101967.....	107	P01102131.....	106	P01120027.....	106	P01120568.....	99
HX0031.....	192	P01101967.....	107	P01102131.....	107	P01120027.....	107	P01120568.....	106
HX0032.....	192	P01101981.....	148	P01102135.....	79	P01120027.....	143	P01120570.....	144
HX0033.....	192	P01101994.....	131	P01102136.....	79	P01120028A.....	141	P01120571.....	144
HX0034B.....	192	P01101995.....	131	P01102136.....	82	P01120029A.....	141	P01120572.....	144
HX0035B.....	192	P01101996.....	79	P01102137.....	79	P01120043A.....	98	P01120575Z.....	28
HX0036.....	192	P01101997Z.....	82	P01102137.....	82	P01120049A.....	142	P01120576Z.....	28
HX0051B.....	26	P01101997Z.....	154	P01102138.....	79	P01120050A.....	142	P01120577Z.....	28
HX0051B.....	81	P01102008Z.....	154	P01102138.....	82	P01120051A.....	142	P01120592.....	98
HX0051B.....	155	P01102009Z.....	154	P01102139.....	79	P01120052A.....	142	P01120592.....	106
HX0053.....	138	P01102013.....	80	P01102139.....	82	P01120053A.....	142	P01120593.....	98
HX0053.....	155	P01102013.....	82	P01102140.....	79	P01120054A.....	142	P01120593.....	106
HX0055B.....	107	P01102014.....	82	P01102140.....	82	P01120055A.....	142	P01120594.....	98
HX0056-Z.....	81	P01102017.....	76	P01102141.....	79	P01120056A.....	142	P01120594.....	106
HX0056-Z.....	82	P01102017.....	78	P01102142.....	79	P01120057A.....	142	P01120600.....	95
HX0056Z.....	107	P01102017.....	81	P01102142.....	82	P01120064.....	142	P01120612.....	143
HX0059B.....	26-172	P01102018.....	76	P01102143.....	79	P01120067A.....	143	P01120630.....	144
HX0061.....	76	P01102018.....	78	P01102143.....	82	P01120074A.....	143	P01120630.....	173
HX0061.....	107	P01102019.....	81	P01102144.....	79	P01120074A.....	173	P01120631.....	144
HX0064.....	155	P01102020.....	78	P01102144.....	82	P01120075.....	141	P01120632.....	144
HX0072.....	192	P01102020.....	81	P01102145.....	79	P01120079B.....	98	P01120633.....	144
HX0073.....	192	P01102021.....	76	P01102145.....	82	P01120079B.....	106	P01120660.....	144
HX0074.....	192	P01102021.....	78	P01102146.....	107	P01120080.....	95	P01120660.....	173
HX0080.....	192	P01102021.....	81	P01102147.....	103	P01120083.....	142	P01120661.....	144
HX0082.....	199	P01102022.....	76	P01102148.....	107	P01120110.....	98	P01120661.....	173
HX0083.....	199	P01102022.....	78	P01102148.....	107	P01120110.....	106	P01120662.....	144
HX0091.....	83	P01102023.....	78	P01102149.....	106	P01120115.....	143	P01120663.....	144
HX0091.....	107	P01102024.....	78	P01102149.....	107	P01120116.....	143	P01120761.....	55
HX0091.....	155	P01102025.....	78	P01102149.....	156	P01120116.....	173	P01120872.....	80
HX0093.....	192	P01102026.....	78	P01102150.....	107	P01120117.....	143	P01120872.....	81
HX0094.....	192	P01102026.....	81	P01102152Z.....	17	P01120125.....	143	P01120921.....	30
HX0099.....	27	P01102026.....	82	P01102152Z.....	17	P01120125.....	173	P01120923.....	30
HX0106.....	155	P01102028.....	78	P01102152Z.....	154	P01120126.....	143	P01120925.....	30
HX0106.....	203	P01102028.....	82	P01102153Z.....	17	P01120127.....	143	P01120941.....	31
HX0107.....	155	P01102029.....	78	P01102153Z.....	154	P01120301.....	142	P01120943.....	31
HX0107.....	203	P01102030.....	78	P01102154Z.....	17	P01120302.....	142	P01120945.....	31
HX0108.....	212	P01102031.....	78	P01102154Z.....	154	P01120303.....	142	P01120947.....	89
HX0122.....	94	P01102031.....	81	P01102155.....	94	P01120304.....	142	P01120963.....	31
HX0130.....	192	P01102035.....	81	P01102155.....	107	P01120304.....	173	P01120965.....	31
HX0179.....	192	P01102036B.....	81	P01102157.....	42	P01120305.....	142	P01120967.....	89
HX0206.....	213	P01102037.....	78	P01102157.....	76	P01120305.....	173	P01122016.....	62
HX0210.....	213	P01102040.....	78	P01102157.....	81	P01120306.....	142	P01122016.....	62
HX0220.....	213	P01102045.....	82	P01102171.....	81	P01120307.....	142	P01122018.....	62
HX0300.....	76	P01102046.....	78	P01102172.....	81	P01120308.....	142	P01122301.....	81
HX0300.....	81	P01102046.....	78	P01102173.....	81	P01120309.....	142	P01126501.....	58
HX0302.....	76	P01102046.....	82	P01102174.....	98	P01120310.....	78	P01126502.....	58
HX0302.....	81	P01102047.....	78	P01102174.....	107	P01120310.....	78	P01126504.....	60
HX0302.....	157	P01102052Z.....	77	P01102177.....	79	P01120310.....	81	P01126505.....	59
MTX 1032-B.....	214	P01102053Z.....	155	P01102177.....	82	P01120314.....	142	P01126506.....	59
MTX 1032-C.....	214	P01102055Z.....	155	P01102178.....	79	P01120315.....	142	P01126510.....	61
MTX1050-PC.....	199	P01102056.....	80	P01102178.....	82	P01120316.....	142	P01127012.....	57
MTX202-Z.....	166	P01102056.....	82	P01102179.....	79	P01120317.....	142	P01127014.....	57
MTX203-Z.....	166	P01102057.....	76	P01102179.....	82	P01120323B.....	98	P01129501.....	131
MTX204-Z.....	166	P01102057.....	107	P01102180.....	79	P01120323B.....	106	P01129600.....	95
MTX3290.....	168	P01102057Z.....	107	P01102180.....	82	P01120330.....	81	P01132503.....	46
MTX3291.....	168	P01102059.....	107	P01102182.....	82	P01120333.....	78	P01132504.....	46
MX 9030.....	214	P01102080.....	98	P01102184.....	95	P01120333.....	81	P01138901.....	51
MX0001-T.....	161	P01102080.....	106	P01102186.....	76	P01120335.....	76	P01138902.....	51
MX0350Z.....	175	P01102080.....	107	P01102186.....	81	P01120335.....	78	P01139711.....	52
MX0355Z.....	175	P01102081.....	98	P01102188.....	27	P01120336.....	76	P01139712.....	53
MX0406B.....	179	P01102081.....	107	P01102190.....	138	P01120336.....	78	P01139713.....	53
MX0531.....	178	P01102082.....	83	P01102191.....	79	P01120401.....	173	P01139714.....	52
MX0604.....	179	P01102082.....	107	P01102192.....	79	P01120401.....	141	P01139715.....	54
MX0650-Z.....	176	P01102083.....	138	P01102193.....	79	P01120402.....	173	P01139716.....	54
MX0655-Z.....	176	P01102084A.....	43	P01102195.....	79	P01120402.....	141	P01140201.....	46
MX0670-Z.....	177	P01102084A.....	43	P01102199.....	80	P01120403.....	141	P01140301.....	46
MX0675-Z.....	177	P01102084A.....	81	P01102200.....	80	P01120404.....	141	P01140822.....	48
MX1.....	161	P01102092.....	81	P01102201.....	80	P01120405.....	141	P01140824.....	48
OX9062.....	191	P01102092A.....	76	P01102202.....	80	P01120406.....	141	P01140826.....	48
OX9102.....	191	P01102094.....	76	P01102203.....	81	P01120407.....	141	P01140832.....	49
OX9104.....	191	P01102095.....	74	P01102203.....	82	P01120408.....	141	P01140834.....	49
OX9302-BUS.....	190	P01102095.....	76	P01103057.....	138	P01120409.....	141	P01140836.....	49
OX9304.....	191	P01102095.....	81	P01103058Z.....	107	P01120410.....	141	P01140838.....	47
P01101141.....	82	P01102095.....	104	P01103058Z.....	155	P01120415.....	141	P01141626.....	73
P01101783.....	80	P01102095.....	106	P01103059Z.....	154	P01120415.....	173	P01143200.....	69
P01101783.....	82	P01102095.....	107	P01103060Z.....	154	P01120416.....	141	P01143221.....	69
P01101784.....	80	P01102095.....	107	P01103061Z.....	154	P01120417.....	141	P01143300.....	70
P01101785.....	138	P01102095.....	111	P01103062Z.....	81	P01120418.....	141	P01145445.....	40
P01101794.....	82	P01102095.....	132	P01103063.....	80	P01120419.....	141	P01145455.....	40
P01101797.....	138	P01102095.....	138	P01103063.....	82	P01120420.....	141	P01145460.....	40
P01101841.....	79	P01102097.....	155	P01103065.....	80	P01120420.....	173	P01145811.....	64
P01101841.....	82	P01102099.....	107	P01103065.....	82	P01120421.....	76	P01145831.....	64
P01101842.....	82	P01102100Z.....	17	P01103071.....	82	P01120421.....	81	P01145851.....	65
P01101846.....	155	P01102100Z.....	138	P01103072.....	82	P01120421.....	141	P01145901.....	148

BY REFERENCE

P01146011.....	42	P01275326.....	150	P01295456Z.....	81	P01298016.....	157	P01654253.....	138
P01146013.....	42	P01275327.....	150	P01295456Z.....	152	P01298031.....	156	P01654402.....	112
P01156302Z.....	124	P01275328.....	150	P01295457Z.....	81	P01298031.....	157	P01654621.....	111
P01156401.....	138	P01275329.....	150	P01295457Z.....	82	P01298032.....	156	P01654623.....	111
P01156401.....	138	P01275330.....	150	P01295457Z.....	138	P01298032.....	157	P01654821.....	122
P01156402.....	138	P01275331.....	150	P01295457Z.....	155	P01298033.....	156	P01654822.....	122
P01157152.....	98	P01275332.....	150	P01295458Z.....	81	P01298033.....	157	P01654823.....	123
P01157153.....	98	P01275333.....	150	P01295458Z.....	82	P01298036.....	156	P01655010.....	136
P01157154.....	98	P01275334.....	150	P01295458Z.....	138	P01298036.....	157	P01655020.....	137
P01157165.....	99	P01275335.....	150	P01295458Z.....	153	P01298037.....	156	P01700105.....	138
P01157166.....	97	P01275339.....	151	P01295459Z.....	22	P01298037.....	157	P01700106.....	133
P01157167.....	97	P01275340.....	151	P01295459Z.....	155	P01298037A.....	156	P01700106.....	138
P01157170.....	103	P01275341.....	151	P01295460Z.....	153	P01298037A.....	157	P01700107.....	133
P01157171.....	103	P01275343.....	151	P01295461Z.....	152	P01298040.....	157	P01700107.....	138
P01157180.....	100	P01275344.....	151	P01295462Z.....	154	P01298043Z.....	156	P01700108.....	138
P01157181.....	101	P01275345.....	151	P01295463Z.....	154	P01298043Z.....	157	P01700108.....	133
P01157182.....	102	P01275346.....	151	P01295464Z.....	154	P01298046.....	157	P01700109.....	138
P01157201.....	103	P01275347.....	151	P01295465.....	77	P01298049.....	81	P01700114.....	138
P01157702.....	71	P01275348.....	151	P01295474Z.....	153	P01298049.....	107	P01700115.....	138
P01160511.....	90	P01275349.....	151	P01295475Z.....	153	P01298049.....	156	P01700116.....	138
P01160541.....	91	P01275350.....	151	P01295476.....	98	P01298049.....	157	P01700117.....	135
P01160591.....	92	P01275351.....	151	P01295476.....	106	P01298051.....	81	P01700117.....	138
P01160595.....	93	P01275352.....	151	P01295476.....	107	P01298051.....	156	P01700118.....	135
P01160620.....	89	P01275353.....	151	P01295477.....	107	P01298051.....	157	P01700118.....	138
P01160640.....	107	P01275357.....	151	P01295479.....	98	P01298055.....	107	P01700119.....	138
P01160657.....	94	P01275358.....	151	P01295479.....	99	P01298055.....	156	P01710010.....	134
P01165221.....	147	P01275359.....	151	P01295479.....	107	P01298055.....	157	P01710015.....	133
P01165222.....	147	P01275360.....	151	P01295483.....	106	P01298056.....	76	P01710016.....	133
P01165223.....	147	P01275361.....	151	P01295483.....	107	P01298056.....	106	P01710020.....	135
P01165224.....	147	P01275362.....	151	P01295486.....	80	P01298056.....	156	P01710050.....	138
P01165225.....	147	P01295056.....	147	P01295486.....	82	P01298056.....	157	P01710050.....	138
P01167501.....	131	P01295056.....	147	P01295487.....	80	P01298057.....	76	P01710051.....	134
P01174810.....	128	P01295094.....	76	P01295487.....	82	P01298057.....	157	P01710051.....	138
P01174830.....	128	P01295097.....	79	P01295488.....	80	P01298061A.....	156	P01710052.....	134
P01174835.....	138	P01295097.....	82	P01295488.....	82	P01298065Z.....	24	P01710052.....	138
P01174902.....	128	P01295137.....	79	P01295489.....	103	P01298065Z.....	81	P01710053.....	138
P01174902.....	138	P01295137.....	82	P01295491Z.....	153	P01298065Z.....	156	P01710054.....	138
P01174903.....	128	P01295140.....	79	P01295492.....	43	P01298065Z.....	157	P01710055.....	138
P01174903.....	138	P01295140.....	82	P01295492.....	81	P01298066.....	81	P01710056.....	133
P01184101.....	125	P01295141.....	79	P01295493.....	81	P01298066.....	82	P01710056.....	138
P01184102.....	125	P01295141.....	82	P01295494.....	80	P01298066.....	82	P01NC5003.....	149
P01185301.....	138	P01295143A.....	80	P01295494.....	82	P01298066.....	107	P03197521A.....	147
P01185501Z.....	126	P01295143A.....	82	P01295495.....	80	P01298066.....	156	P03197521A.....	210
P01191303.....	72	P01295145.....	82	P01295495.....	82	P01298066.....	157	P03197522A.....	147
P01191304.....	72	P01295171.....	81	P01295496.....	107	P01298067.....	82	P03197522A.....	210
P01191305.....	72	P01295172.....	79	P01295501.....	138	P01298067.....	156	P03197523A.....	147
P01191306.....	44	P01295172.....	81	P01295502.....	138	P01298067.....	157	P03197523A.....	210
P01191611.....	43	P01295172.....	82	P01295506.....	77	P01298067.....	157	P03197524A.....	147
P01191739Z.....	24	P01295173.....	79	P01295507.....	77	P01298067.....	156	P03197524A.....	210
P01191740Z.....	24	P01295173.....	81	P01295508.....	77	P01298069.....	156	P03197525A.....	147
P01191742D.....	19	P01295174.....	76 - 81 - 98	P01295510.....	77	P01298071.....	97	P03197525A.....	210
P01191742Z.....	19	P01295174.....	107	P01295511.....	77	P01298071.....	138	P03197526A.....	147
P01191745Z.....	16	P01295212.....	148	P01295512.....	77	P01298071.....	156	P03197526A.....	210
P01191748Z.....	17	P01295231.....	77	P01295513.....	77	P01298072.....	156	P03197527A.....	147
P01191748Z.....	20	P01295232.....	77	P01295514.....	77	P01298072.....	157	P03197527A.....	210
P01191748Z.....	155	P01295234.....	79	P01295515.....	77	P01298074.....	17	P03197528A.....	147
P01191755.....	17	P01295236.....	79	P01295516.....	77	P01298074.....	156	P03197528A.....	210
P01191757.....	17	P01295236.....	82	P01295517.....	77	P01298074.....	157	P03197704.....	129
P01191762D.....	19	P01295252.....	81	P01295518.....	77	P01298075.....	138	P03199611A.....	147
P01191762Z.....	19	P01295252.....	81	P01295519.....	77	P01298075.....	156	P03199612A.....	147
P01191771.....	20	P01295253.....	81	P01295520.....	77	P01298075.....	157	P03199613A.....	147
P01191771A.....	20	P01295253.....	82	P01295521.....	77	P01298076.....	101	P03295509.....	22
P01191773.....	20	P01295260.....	78	P01295522.....	77	P01298076.....	107	P03295509.....	81
P01191773A.....	20	P01295261.....	78	P01295523.....	77	P01298076.....	156	P03295509.....	107
P01192200.....	27	P01295262.....	78	P01295524.....	77	P01298076.....	157	P03295509.....	155
P01194200.....	27	P01295263.....	78	P01295525.....	77	P01298078.....	98	P03295514.....	81
P01196311E.....	22	P01295264.....	78	P01295526.....	77	P01298078.....	107	P03298504.....	157
P01196521E.....	22	P01295265.....	78	P01296021.....	81	P01298078.....	156	P03652712.....	137
P01196522E.....	22	P01295266.....	78	P01296024.....	76	P01298078.....	157	P03652713.....	137
P01196523E.....	22	P01295266.....	81	P01296024.....	107	P01298080.....	81	P03652714.....	137
P01196731.....	24	P01295267.....	78	P01296032.....	16	P01298080.....	157	P03652715.....	137
P01196733.....	24	P01295268.....	78	P01296032.....	17	P01298081.....	76	P03652901.....	136
P01196734.....	24	P01295268.....	81	P01296033.....	17	P01298082.....	76	P03652902.....	136
P01196773.....	5	P01295268.....	82	P01296033.....	81	P01298083.....	94	P03652903.....	136
P01196775.....	25	P01295270.....	78	P01296034.....	81	P01298083.....	107	P03652904.....	136
P01196777.....	25	P01295271.....	61	P01296037.....	107	P01299926.....	43	P03652905.....	136
P01196802.....	26	P01295271.....	82	P01296047.....	76	P01637301.....	107	P03652906.....	136
P01196803.....	26	P01295272.....	82	P01296047.....	94	P01651001Z.....	129	P03652907.....	136
P01196812.....	26	P01295285Z.....	154	P01297012.....	81	P01651011.....	130	P03652908.....	136
P01196813.....	26	P01295288Z.....	107	P01297022.....	81	P01651020.....	138	P03652909.....	137
P01197201.....	81	P01295288Z.....	152	P01297071.....	81	P01651021.....	138	P03652910.....	137
P01197401.....	147	P01295289Z.....	81	P01297072.....	81	P01651022.....	138	P03652912.....	137
P01197401.....	210	P01295289Z.....	152	P01297086.....	79	P01651023.....	107	P03652913.....	137
P01197402.....	147	P01295290Z.....	152	P01297086.....	82	P01651023.....	138	P03652914.....	137
P01197402.....	210	P01295291.....	78	P01297089.....	82	P01651023.....	155	P03652917.....	136
P01197403.....	147	P01295291.....	82	P01297090.....	82	P01651030.....	126	P03652918.....	136
P01197404.....	147	P01295292.....	78	P01297095.....	81	P01651101.....	129	P03652919.....	136
P01197404.....	210	P01295292.....	82	P01297101.....	82	P01651101.....	138	P03652920.....	136
P01197451.....	147	P01295293.....	76	P01297102.....	79	P01651403Z.....	120	P03652921.....	136
P01197451.....	210	P01295293.....	82	P01297103.....	82	P01651610Z.....	120	P03652922.....	136
P01275101.....	150	P01295293.....	106	P01297103.....	79	P01651810Z.....	148	P03652925.....	137
P01275301.....	151	P01295293.....	107	P01297103.....	82	P01651813.....	119	P06239307.....	155
P01275302.....	151	P01295293.....	138	P01298004.....	156	P01651814.....	119	P06239502.....	81
P01275304.....	150	P01295294.....	82	P01298004.....	157	P01651815.....	119	P06239502.....	156
P01275304.....	151	P01295393.....	40	P01298005.....	81	P01651816.....	119	P06239502.....	157
P01275305.....	151	P01295393.....	76	P01298005.....	157	P01651901.....	114	SX-METRO/P.....	27
P01275306.....	151	P01295398.....	40	P01298006.....	81	P01651902.....	113	SX-METRO/P.....	195
P01275307.....	151	P01295398.....	76	P01298006.....	156	P01651904.....	115	TX001-Z.....	162
P01275308.....	151	P01295450Z.....	81	P01298006.....	157	P01651904.....	121	TX001-Z.....	161
P01275309.....	151	P01295450Z.....	152	P01298007.....	156	P0165110.....	121	VX0003.....	162
P01275310.....	151	P01295451Z.....	138	P01298007.....	157	P01654110.....	127	VX0100.....	162
P01275311.....	151	P01295451Z.....	152	P01298009B.....	157	P01654227.....	125		
P01275312.....	151	P01295452Z.....	152	P01298011.....	156	P01654246.....	81		
P01275313.....	151	P01295453Z.....	81	P01298011.....	157	P01654246.....	82		
P01275314.....	151	P01295453Z.....	152	P01298012.....	156	P01654246.....	124		
P01275315.....	151	P01295454Z.....	81	P01298012.....	157	P01654250.....	138		
P01275316.....	151	P01295454Z.....	107	P01298012Z.....	157	P01654251.....	138		
P01275318.....	151	P01295454Z.....	153	P01298015.....	157	P01654252.....	101		
P01275325.....	150	P01295455Z.....	152	P01298016.....	81</				