



**JBC**

The Soldering Co.

## **Cartridge Guide**

Feel the quality, be exclusive

# Index

---

Most Efficient Soldering System.....	4
Bigger is better .....	6
Factors limiting tip life .....	7
Cleaning Systems .....	8
C115 Cartridge Range for NT115, AN115 and NP115 Nano Tools .....	12
C120 Cartridge Range for PA120 and AM120 Micro Tweezers .....	16
C210 Cartridge Range for T210 Precision Handles .....	18
C245 Cartridge Range for T245 General Purpose Handles.....	22
C245E Extended Tip Life Cartridge Range for T245 General Purpose Handles .....	44
C250 Cartridge Range for AL250 Auto-Feed Iron and AP250 Solder Feed Iron .....	46
C420 Cartridge Range for AT420 and HT420 Thermal Tweezers.....	49
C470 Cartridge Range for T470 HD Handles and HT470 HD Thermal Tweezers.....	51
C360 Tip Range for DS360 Micro Desoldering Iron .....	59
C560 Tip Range for DR560 Desoldering Iron.....	61
W140 Blade Cartridge Range for WS140 Precision High-Temperature Wire Stripper Tweezers .....	63
W440 Blade Cartridge Range for WS440 High-Temperature Wire Stripper Tweezers .....	65

## A global organization at your service

JBC is a global company with a distributor network spanning 5 continents that guarantees a solid commercial organization with quick and efficient service.

## The power of experience

More than 90 years of experience have placed JBC at the technological forefront of tools for soldering and rework operations in electronics. Innovation, efficiency and reliability are the key features of a wide range of products which have been designed to satisfy the most demanding requirements of professionals.

## High technology, superior quality

Product perfection is one of the main objectives of JBC's improvement and development program. The R&D department has created the most innovative soldering technologies, which JBC is proud to present in this catalogue.



All JBC products comply with CE standards and ESD recommendations.



JBC Soldering S.L. reserves the right to update, modify or delete any information without previous notice.

# Most Efficient Soldering System

## JBC Exclusive Heating System

JBC Stations work with JBC Exclusive Heating System, which recovers tip temperature extremely quickly. This increases work efficiency and allows the user to work with lower temperatures.

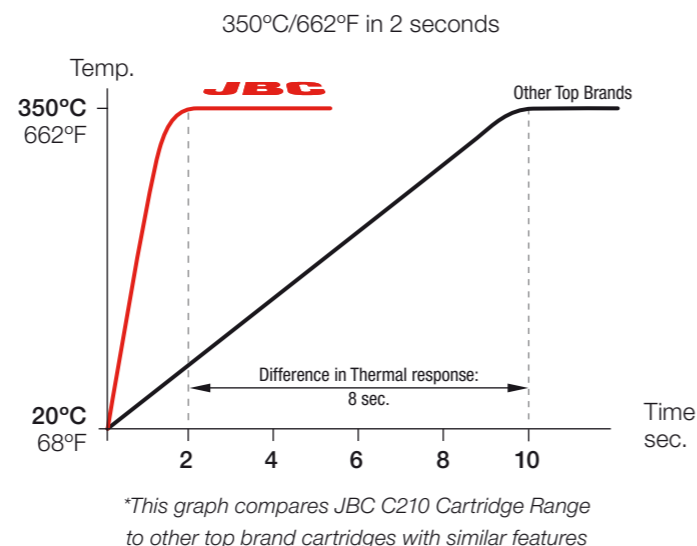

Enhanced Temperature Efficiency → Increased Productivity + Better Quality

## Efficient Temperature Control

Comparative process of 3 solder joints

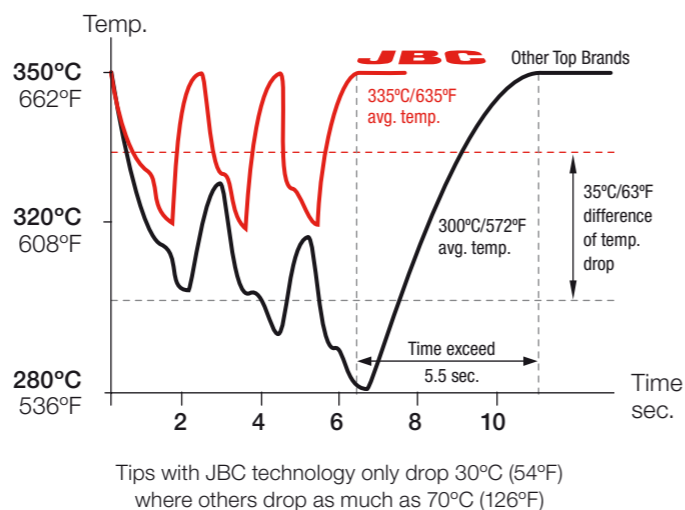

## Intelligent Heat Management

Thanks to automatic detection of the tool in the stand, JBC Soldering and Rework Stations allow the tools to enter into **Sleep and Hibernation** Modes when not being used. As a result, tip life lasts up to 5 times longer.

### Sleep Mode

**Sleep Mode** automatically lowers tip temperature below the solder melting point when the tool rests in the stand.

It prevents the dissolution of the tip iron coating into molten solder.

### Hibernation Mode

After a configurable period of tool inactivity in the stand, the tool enters into **Hibernation Mode**.

It cuts off the power supply making the tip reach room temperature thus preventing oxidation and saving energy.

### Longer Tip life

Tip life increases exponentially by using lower temperatures as shown. Using Sleep Mode, the temperature is further reduced, which multiplies tip life by 5.

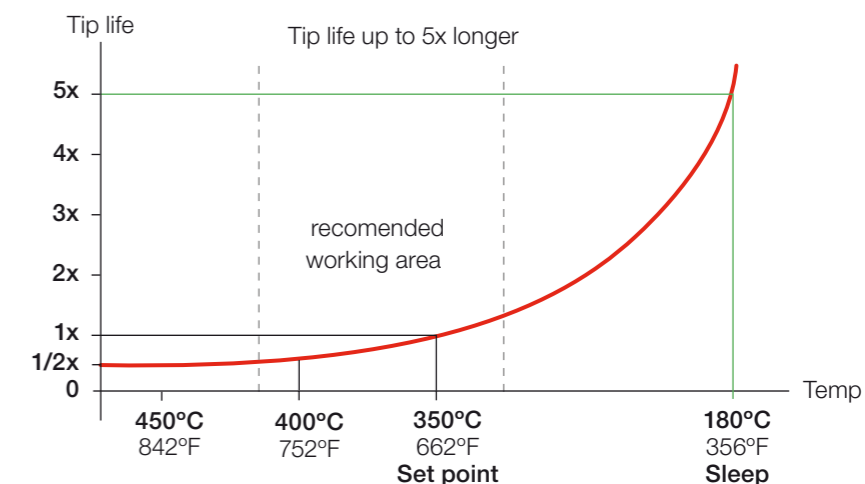
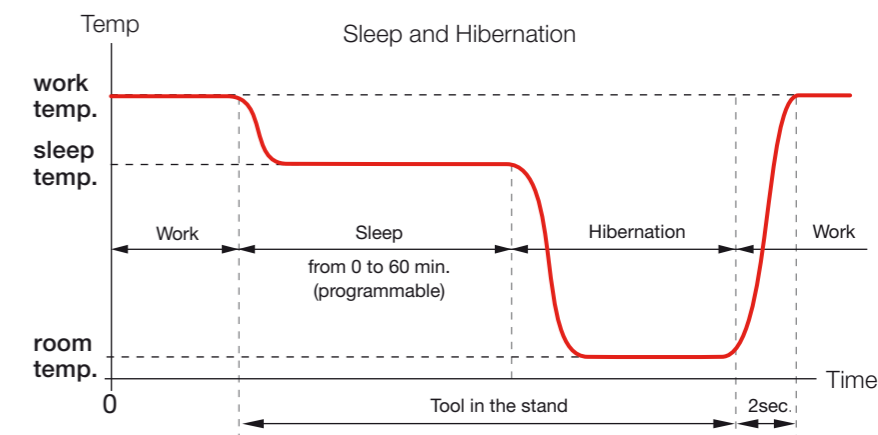

## Cartridges with extended tip life

The essential part of the soldering iron is the tip so JBC has **over 500 cartridge models of different shapes and sizes** to choose from, depending on each application.

JBC has developed the most advanced technology based on the following principles:

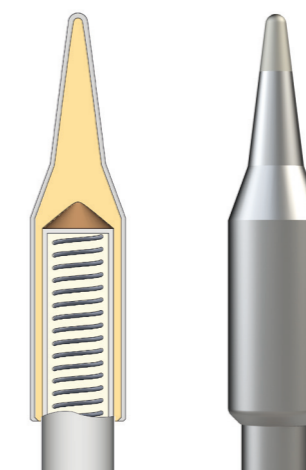

- **Excellent Heat Transfer**  
The compact element reduces thermal barriers.
- **Instantaneous Heating**  
A fully-integrated thermal sensor in the heater ensures quick temperature recovery.
- **Great Durability**  
The intelligent algorithm control program extends tip life.

When you start working do not forget:

## Bigger is better

The bigger the solder tip, the better the thermal transfer. Select the tip that has the greatest contact area.

### Over 500 tips of different sizes, shapes and power

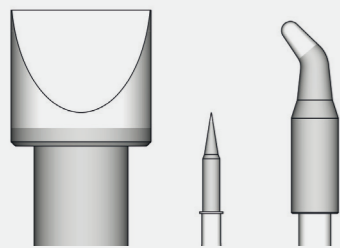

JBC Cartridges range from models for precision work to high power requirement applications.

### Geometry Slimness vs Efficiency

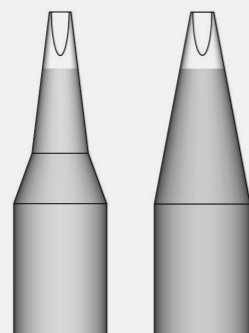

A tip with high thermal efficiency makes your job up to **40% faster** than a tip with a slimmer geometry.

### Increase the contact surface Tip - Application

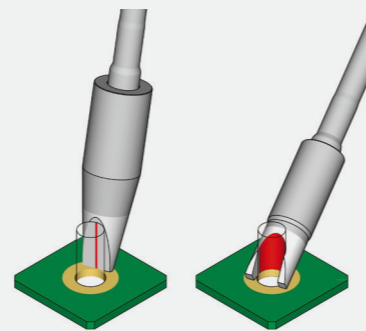

The bigger the contact surface that the tip has with the application, the higher the **thermal transfer**.

### Largest mass possible

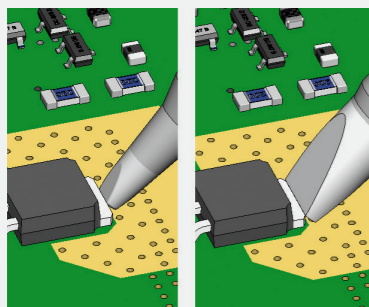

The more mass the tip has, the more heat is accumulated and the **lower is the temperature drop**.

### Maintain tip surface clean and tinned



Remember that rusty and dirty surfaces reduce **heat transfer** to the solder joint.

(See JBC's cleaning methods on pages 8-9).

### This way you will be able to:

- work at **lower temperatures** (350°C / 662°F).
- obtain **better results** in **less time**.
- improve **thermal performance**.
- increase **temperature precision**.
- reduce **collateral damage** (thermal shock on components and PCBs).

## Factors limiting tip life

### Working temperature

The higher the temperature, the greater the oxidation and corrosion. Work with the **lowest possible temperature** and choose the tip with the greatest contact area for each application. **Use thermally efficient tools** and keep tips clean of oxidation.

### Correct techniques

Too much pressure on the surface to solder can cause tip or plate breakage. Do not use the tip as a pointed object or a screwdriver. Choose the **right temperature and tip shape for each application**.

### Iron plate thickness

Iron plate wear shortens tip life by hollowing tips out. Do not use mechanical or chemical means to clean the tip. Use the **cleaning methods provided by the manufacturer** - such as brass wool, automatic tip cleaner or sponges.

### Oxidization

An oxidized soldering iron does neither wet nor transfer heat well (dewetting). The higher the temperature, the greater the risk of oxidation. **Always keep tips tinned while not in use** and take advantage of **JBC Sleep and Hibernation Modes**.

### Flux and solder alloy

Too much active flux can cause corrosion. **IPC recommends: ROL, REL and ORL**. Flux quantity inside small diameter solder wires might not be enough. **Provide compatible external flux if necessary**.

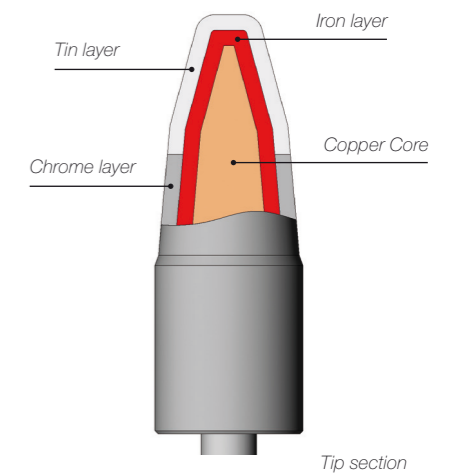

### Remember

- Work with the **lowest possible temperature**.
- Use **thermally efficient tools**.
- Choose the **right temperature and tip shape for each application**.
- **IPC recommends: ROL, REL and ORL**.
- **Always keep tips tinned while not in use**.
- Take advantage of **JBC Sleep and Hibernation Modes**.
- **Too much pressure** on the surface to solder can cause **tip or plate breakage**.
- Use the **cleaning methods provided by the manufacturer**.

# Cleaning Systems

For good thermal transfer, keep the tip tinned thus free from oxides.

## Clean the tip in less than a second



With automatic cleaners you **save time** and **optimize production**.

## Improve heat transfer

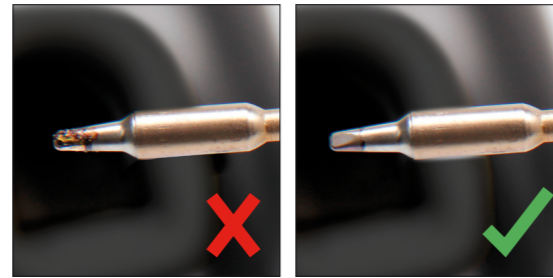

A clean tip is always easier to tin, resulting in **higher quality solder joints**.

JBC offers effective, practical and affordable methods to prevent splashing and extend tip life:

## Easy to empty



The solder collector tray can be **easily emptied** and **re-used** with no wear and tear.

## Keep your work area clean



The locking mechanism on the brushes makes them **fast and easy to replace**.

## CLM Manual Tip Cleaner

➤ A complete cleaning system with splashguard and antispash membrane to keep the work area clean and free of solder particles.

### Antispash rubber

Ref. **CL7882**  
Prevent splashing of solder particles and maintain the work area clean.

### Brass Wool

Ref. **CL6210**  
Very effective cleaning method. It leaves a small layer of solder on the tip to prevent oxidation between cleaning and rewetting.



### ESD-safe Tip Wiper

Ref. **CL8010**  
A temperature-resistant receptacle lets the operator remove excess solder by gently tapping or wiping.

### Sponge

Ref. **S0354**  
The least harmful cleaning method. Keep the sponge moist with distilled water when working to avoid tip wear.



### Non-slip Base

No need to hold the base while cleaning tips.

## CLU Senior Tip Cleaner

### Continuous or Sensor Mode

This cleaner is excellent for cleaning tips of different shapes and sizes. You can easily switch between sensor and continuous mode by pressing the top buttons.



It also features a second position which facilitates vertical tip access

### Brushes for CLU





Our Cartridge Range is steadily growing as we are determined to respond to our clients' specific needs, cooperating closely with them to create **the right solution.**

**C115 Cartridge Range**  
for **NT115, AN115** and **NP115** Nano Tools





Ref.	Description	Image and dimensions	Suggested components	Compatible with
<b>C115116</b>	Chisel Cartridge 0.2 x 0.1 mm 0.008 x 0.004 in		Package 01005, 0201 Very fine pitch 0.4 mm QFP, IC	Stations: NAS, NAN Tools: NT115, AN115, NP115
<b>C115117</b>	Chisel Cartridge 0.4 x 0.2 mm 0.016 x 0.008 in		Package 0402 Very fine pitch 0.65 mm QFP, IC	Stations: NAS, NAN Tools: NT115, AN115, NP115
<b>C115108</b>	Chisel Cartridge 0.6 x 0.3 mm 0.024 x 0.012 in		Package 0603 PLCC, SO, SOT	Stations: NAS, NAN Tools: NT115, AN115, NP115
<b>C115125</b>	Chisel Cartridge 1 x 0.2 mm 0.039 x 0.008 in		Package 0805 Difficult to reach	Stations: NAS, NAN Tools: NT115, AN115, NP115
<b>C115113</b>	Chisel Cartridge 1 x 0.3 mm 0.039 x 0.012 in		Package 0805 Through-hole	Stations: NAS, NAN Tools: NT115, AN115, NP115
<b>C115213</b>	Chisel Cartridge 1 x 0.3 S1 mm 0.039 x 0.012 in		Package 0805 Through-hole High thermal performance	Stations: NAS, NAN Tools: NT115, AN115, NP115
<b>C115221</b>	Chisel Cartridge 1.3 x 0.3 mm 0.051 x 0.012 in		Package 0805 Through-hole High thermal performance	Stations: NAS, NAN Tools: NT115, AN115, NP115





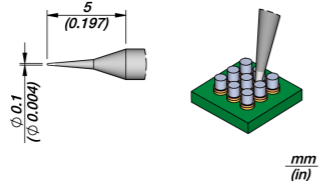
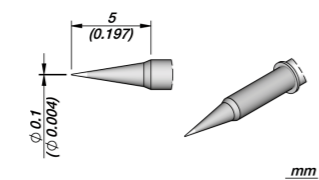
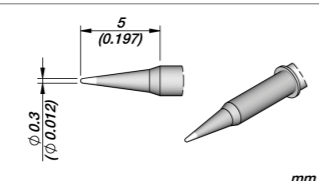
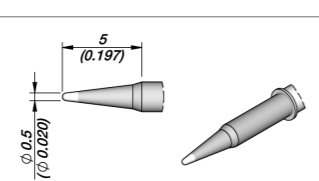
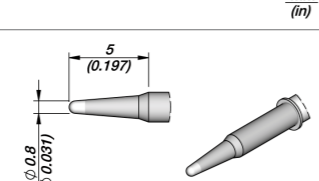

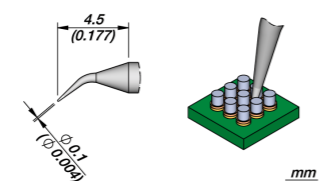
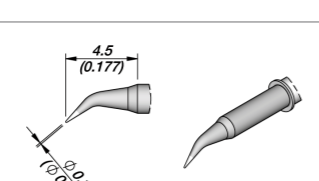
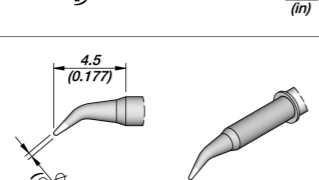
**C115 Cartridge Range** for **NT115, AN115** and **NP115** Nano Tools

Ref.	Description	Image and dimensions	Suggested components	Compatible with
<b>C115222</b>	Chisel Cartridge 1.6 x 0.3 mm 0.063 x 0.012 in		Package 0805 Through-hole High thermal performance	Stations: NAS, NAN Tools: NT115, AN115, NP115
<b>C115114</b>	Chisel Cartridge 1.8 x 0.5 mm 0.071 x 0.020 in		Package 0805 Through-hole High thermal performance	Stations: NAS, NAN Tools: NT115, AN115, NP115
<b>C115214</b>	Chisel Cartridge 1.8 x 0.5 mm S1 0.071 x 0.020 in		Package 1206, 1210 Through-hole	Stations: NAS, NAN Tools: NT115, AN115, NP115
<b>C115131</b>	Chisel Cartridge 2 x 0.35 mm 0.079 x 0.014 in		LED SMD 2727, 1921, 1415	Stations: NAS, NAN Tools: NT115, AN115, NP115
<b>C115223</b>	Chisel Cartridge 2.4 x 0.6 mm 0.094 x 0.024 in		Package 0805 Through-hole High thermal performance	Stations: NAS, NAN Tools: NT115, AN115, NP115
<b>C115109</b>	Bevel Cartridge Ø 0.6 mm Ø 0.024 in		Drag soldering SMD Through-hole	Stations: NAS, NAN Tools: NT115, AN115, NP115
<b>C115127</b>	Bevel Cartridge Ø 1 mm Ø 0.039 in		Drag soldering SMD Through-hole	Stations: NAS, NAN Tools: NT115, AN115, NP115
<b>C115128</b>	Spoon Cartridge Ø 1 mm Ø 0.039 in		Drag soldering SMD Through-hole	Stations: NAS, NAN Tools: NT115, AN115, NP115

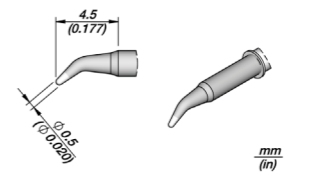
**C115 Cartridge Range for NT115, AN115 and NP115 Nano Tools**

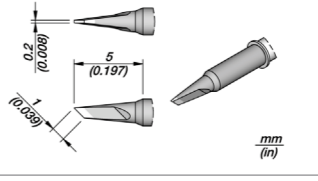
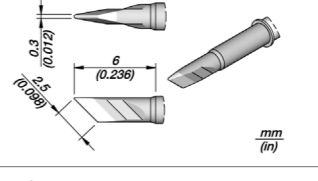
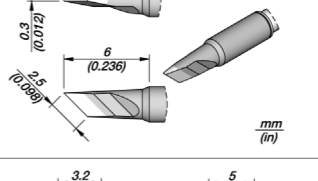
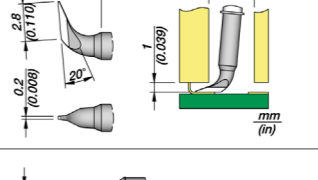
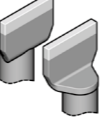
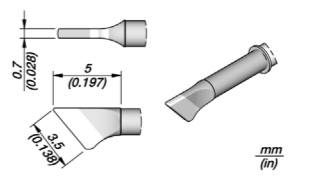
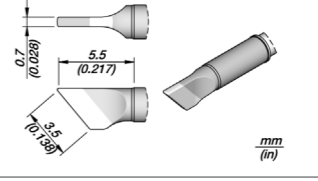
	Ref.	Description	Image and dimensions	Suggested components	Compatible with
	<b>C115126</b>	Conical Cartridge Ø 0.1 mm S1 Ø 0.004 in		Package 01005 Very fine pitch 0.4 mm QFP, IC	Stations: NAS, NAN Tools: NT115, AN115, NP115
	<b>C115101</b>	Conical Cartridge Ø 0.1 mm Ø 0.004 in		Package 01005 Very fine pitch 0.4 mm QFP, IC	Stations: NAS, NAN Tools: NT115, AN115, NP115
	<b>C115103</b>	Conical Cartridge Ø 0.3 mm S1 Ø 0.012 in		Package 0201, 0402 Very fine pitch 0.65 mm QFP, IC	Stations: NAS, NAN Tools: NT115, AN115, NP115
	<b>C115106</b>	Conical Cartridge Ø 0.5 mm Ø 0.020 in		Package 0603 QFP, IC	Stations: NAS, NAN Tools: NT115, AN115, NP115
	<b>C115107</b>	Conical Cartridge Ø 0.8 mm Ø 0.031 in		General use	Stations: NAS, NAN Tools: NT115, AN115, NP115
	<b>C115124</b>	Conical Bent Cartridge Ø 0.1 mm S1 Ø 0.004 in		Package 01005 Very fine pitch 0.4 mm QFP, IC	Stations: NAS, NAN Tools: NT115, AN115, NP115
	<b>C115118</b>	Conical Bent Cartridge Ø 0.1 mm Ø 0.004 in		Package 01005 Very fine pitch 0.4 mm QFP, IC	Stations: NAS, NAN Tools: NT115, AN115, NP115
	<b>C115105</b>	Conical Bent Cartridge Ø 0.3 mm Ø 0.012 in		Package 0201, 0402 Fine pitch 0.65 mm QFP, IC	Stations: NAS, NAN Tools: NT115, AN115, NP115

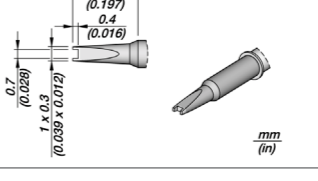
**C115 Cartridge Range for NT115, AN115 and NP115 Nano Tools**

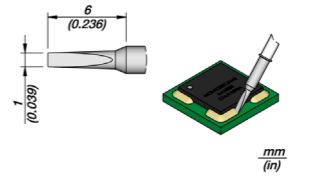
	Ref.	Description	Image and dimensions	Suggested components	Compatible with
	<b>C115110</b>	Conical Bent Cartridge Ø 0.5 mm Ø 0.020 in		Package 0603 QFP, IC	Stations: NAS, NAN Tools: NT115, AN115, NP115
	<b>C115120</b>	Knife Cartridge 1 x 0.2 mm 0.039 x 0.008 in		Drag soldering SMD Package 0805 Through-hole	Stations: NAS, NAN Tools: NT115, AN115, NP115
	<b>C115112</b>	Knife Cartridge 2.5 x 0.3 mm 0.098 x 0.012 in		Drag soldering SMD SO, SOT Package 1210, 1812, 2010, 2512 High thermal performance	Stations: NAS, NAN Tools: NT115, AN115, NP115
	<b>C115212</b>	Knife Cartridge 2.5 x 0.3 mm S1 0.098 x 0.012 in		Drag soldering SMD SO, SOT Package 1210, 1812, 2010, 2512	Stations: NAS, NAN Tools: NT115, AN115, NP115
	<b>C115129</b>	Knife Cartridge 2.8 x 0.2 mm 0.110 x 0.008 in		IC, Difficult to reach	Stations: NAS, NAN Tools: NT115, AN115, NP115
	<b>C115111</b>	Blade Cartridge 3.5 x 0.7 mm 0.138 x 0.028 in		Package 1210, 1812 SO, SOT	Stations: NAS, NAN Tools: NT115, AN115, NP115
	<b>C115211</b>	Blade Cartridge 3.5 x 0.7 mm S1 0.138 x 0.028 in		Package 1210, 1812 SO, SOT High thermal performance	Stations: NAS, NAN Tools: NT115, AN115, NP115
	<b>C115132</b>	Chip Components Cartridge 0.7 mm 0.028 in		Package 0201	Stations: NAS, NAN Tools: NT115, AN115, NP115
	<b>C115115</b>	Conformal Coating Removal Steel Cartridge 1 mm 0.039 in		Stainless Steel Remove underfill encapsulants	Stations: NAS, NAN Tools: NT115, AN115, NP115





**C120 Cartridge Range**  
for PA120 and AM120 Micro Tweezers

	Ref.	Description	Image and dimensions	Suggested components	Compatible with
	<b>C120001</b>	Conical Bent Cartridge Ø 0.2 mm Ø 0.008 in		Package 0201, 0402	Stations: CDP, DIU, DDU, DMU Tools: AM120, PA120
	<b>C120002</b>	Conical Bent Cartridge Ø 0.2 mm Ø 0.008 in		Package 0201, 0402	Stations: CDP, DIU, DDU, DMU Tools: AM120, PA120
	<b>C120902</b>	Conical Bent Cartridge Ø 0.3 mm Ø 0.012 in		Package 0201, 0402 Fine pitch 0.65 mm QFP, IC	Stations: CDP, DIU, DDU, DMU Tools: AM120, PA120
	<b>C120006</b>	Conical Bent Cartridge Ø 0.5 mm Ø 0.020 in		Package 0603 QFP, IC	Stations: CDP, DIU, DDU, DMU Tools: AM120, PA120
	<b>C120004</b>	Conical Bent Cartridge Ø 0.7 mm S1 Ø 0.028 in		SMD capacitors QFP, IC Through-hole	Stations: CDP, DIU, DDU, DMU Tools: AM120, PA120
	<b>C120012</b>	Conical Bent Cartridge Ø 0.7 mm S2 Ø 0.028 in		SMD capacitors QFP, IC Through-hole Tip with an extra tinned surface	Stations: CDP, DIU, DDU, DMU Tools: AM120, PA120
	<b>C120011</b>	Chisel Bent Cartridge 0.6 x 0.3 mm 0.024 x 0.012 in		Package 0603	Stations: CDP, DIU, DDU, DMU Tools: AM120, PA120

**C120 Cartridge Range for PA120 and AM120 Micro Tweezers**



	Ref.	Description	Image and dimensions	Suggested components	Compatible with
	<b>C120013</b>	Blade Cartridge 2 mm 0.079 in		LED SMD 2727, 1921, 1415	Stations: CDP, DIU, DDU, DMU Tools: AM120, PA120
	<b>C120003</b>	Blade Cartridge 3 mm 0.118 in		Package 1210, 1812 SO, SOT	Stations: CDP, DIU, DDU, DMU Tools: AM120, PA120
	<b>C120007</b>	Blade Cartridge 3.5 mm Right 0.138 in		Package 1210, 1812 SO, SOT	Stations: CDP, DIU, DDU, DMU Tools: AM120, PA120
	<b>C120008</b>	Blade Cartridge 3.5 mm Left 0.138 in		Package 1210, 1812 SO, SOT	Stations: CDP, DIU, DDU, DMU Tools: AM120, PA120
	<b>C120005</b>	Blade Cartridge 5 mm 0.197 in		SO, SOT	Stations: CDP, DIU, DDU, DMU Tools: AM120, PA120
	<b>C120009</b>	Blade Cartridge 6 mm Right 0.236 in		SO, SOT	Stations: CDP, DIU, DDU, DMU Tools: AM120, PA120
	<b>C120010</b>	Blade Cartridge 6 mm Left 0.236 in		SO, SOT	Stations: CDP, DIU, DDU, DMU Tools: AM120, PA120



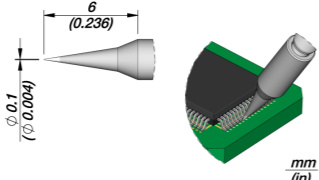
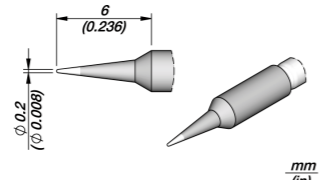
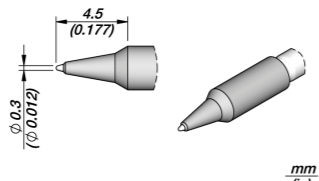
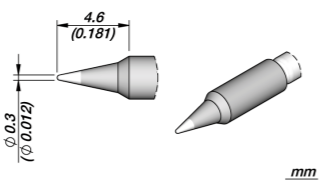
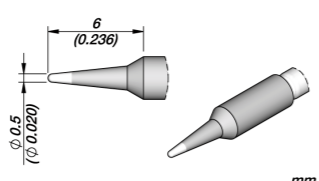
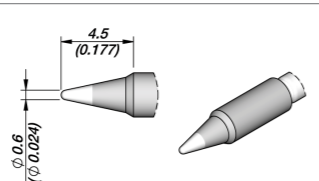
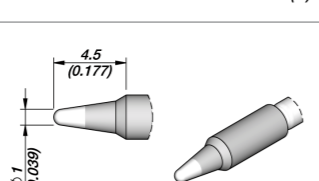

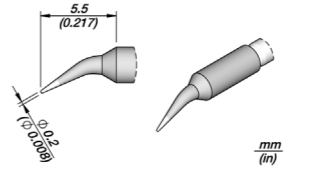
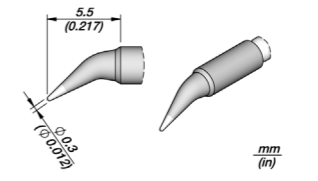
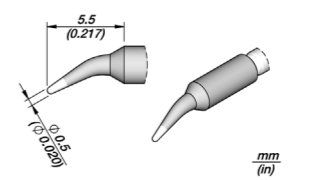
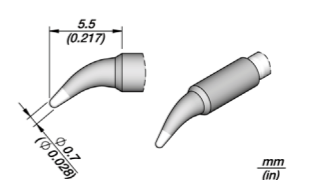

**C210 Cartridge Range**  
for T210 Precision Handles

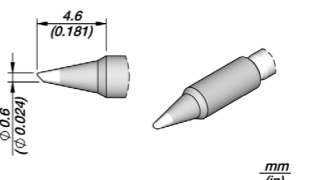
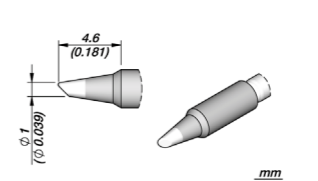
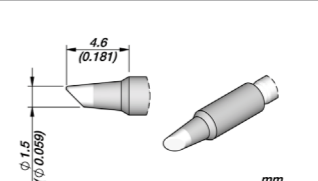
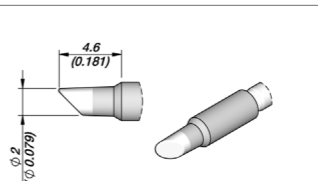
	Ref.	Description	Image and dimensions	Suggested components	Compatible with
	<b>C210020</b>	Conical Cartridge Ø 0.1 mm Ø 0.004 in		Package 01005, 0201 Very fine pitch 0.4 mm QFP, IC	Stations: CDS, CDES, DIU, DDU, DMU Tools: T210, T210P, T210N
	<b>C210009</b>	Conical Cartridge Ø 0.2 mm Ø 0.008 in		Package 01005, 0201 Very fine pitch 0.4mm QFP, IC	Stations: CDS, CDES, DIU, DDU, DMU Tools: T210, T210P, T210N
	<b>C210016</b>	Conical Cartridge Ø 0.3 mm S1 Ø 0.012 in		Package 0201, 0402 Fine pitch 0.65 mm QFP, IC	Stations: CDS, CDES, DIU, DDU, DMU Tools: T210, T210P, T210N
	<b>C210001</b>	Conical Cartridge Ø 0.3 mm S2 Ø 0.012 in		Package 0201, 0402 Fine pitch 0.65 mm QFP, IC	Stations: CDS, CDES, DIU, DDU, DMU Tools: T210, T210P, T210N
	<b>C210013</b>	Conical Cartridge Ø 0.5 mm Ø 0.020 in		Package 0603 QFP, IC	Stations: CDS, CDES, DIU, DDU, DMU Tools: T210, T210P, T210N
	<b>C210003</b>	Conical Cartridge Ø 0.6 mm Ø 0.024 in		General use	Stations: CDS, CDES, DIU, DDU, DMU Tools: T210, T210P, T210N
	<b>C210005</b>	Conical Cartridge Ø 1 mm Ø 0.039 in		General use	Stations: CDS, CDES, DIU, DDU, DMU Tools: T210, T210P, T210N



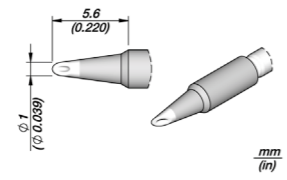
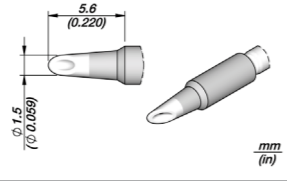
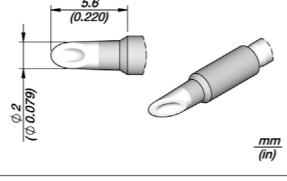

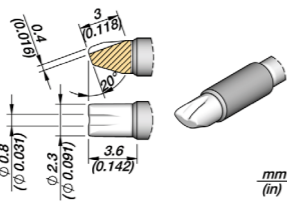

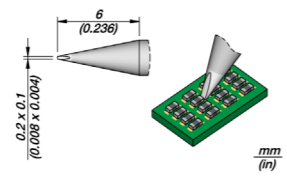
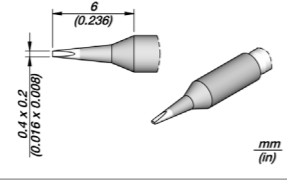
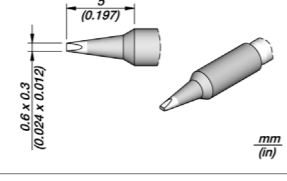
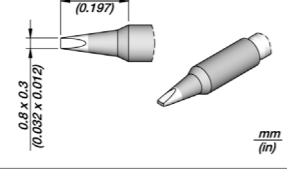
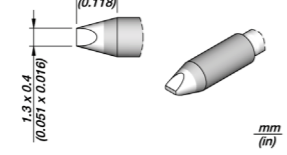
**C210 Cartridge Range for T210 Precision Handles**

	Ref.	Description	Image and dimensions	Suggested components	Compatible with
	<b>C210002</b>	Conical Bent Cartridge Ø 0.2 mm Ø 0.008 in		Package 0201, 0402	Stations: CDS, CDES, DIU, DDU, DMU Tools: T210, T210P, T210N
	<b>C210010</b>	Conical Bent Cartridge Ø 0.3 mm Ø 0.012 in		Package 0201, 0402 Fine pitch 0.65 mm QFP, IC	Stations: CDS, CDES, DIU, DDU, DMU Tools: T210, T210P, T210N
	<b>C210014</b>	Conical Bent Cartridge Ø 0.5 mm Ø 0.020 in		Package 0603 QFP, IC	Stations: CDS, CDES, DIU, DDU, DMU Tools: T210, T210P, T210N
	<b>C210004</b>	Conical Bent Cartridge Ø 0.7 mm Ø 0.028 in		General use	Stations: CDS, CDES, DIU, DDU, DMU Tools: T210, T210P, T210N
	<b>C210036</b>	Bevel Cartridge Ø 0.6 mm Ø 0.024 in		Drag Soldering General use	Stations: CDS, CDES, DIU, DDU, DMU Tools: T210, T210P, T210N
	<b>C210006</b>	Bevel Cartridge Ø 1 mm Ø 0.039 in		Drag Soldering General use	Stations: CD, CDE, DIU, DDU, DMU Tools: T210, T210P, T210N
	<b>C210027</b>	Bevel Cartridge Ø 1.5 mm Ø 0.059 in		Drag Soldering General use	Stations: CDS, CDES, DIU, DDU, DMU Tools: T210, T210P, T210N
	<b>C210031</b>	Bevel Cartridge Ø 2 mm Ø 0.079 in		Drag Soldering General use	Stations: CDS, CDES, DIU, DDU, DMU Tools: T210, T210P, T210N

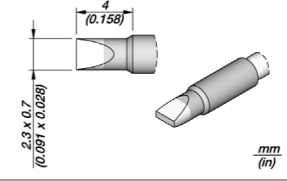
**C210 Cartridge Range for T210 Precision Handles**

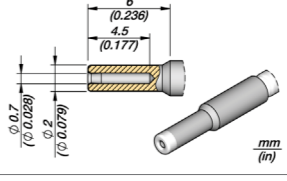
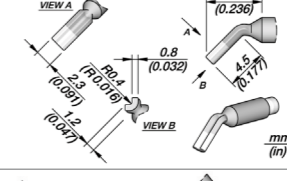
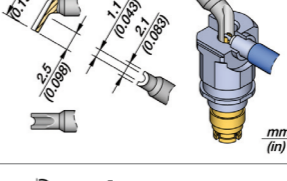
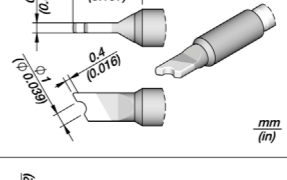
	Ref.	Description	Image and dimensions	Suggested components	Compatible with
	<b>C210028</b>	Spoon Cartridge Ø 1 mm Ø 0.039 in		Drag soldering	Stations: CDS, CDES, DIU, DDU, DMU Tools: T210, T210P, T210N
	<b>C210029</b>	Spoon Cartridge Ø 1.5 mm Ø 0.059 in		Drag soldering	Stations: CDS, CDES, DIU, DDU, DMU Tools: T210, T210P, T210N
	<b>C210030</b>	Spoon Cartridge Ø 2 mm Ø 0.079 in		Drag soldering	Stations: CDS, CDES, DIU, DDU, DMU Tools: T210, T210P, T210N
	<b>C210038</b>	Barrell Cartridge Ø 8 mm Ø 0.031 in		Through-hole Cable soldering / desoldering	Stations: CDS, CDES, DIU, DDU, DMU Tools: T210 handles
	<b>C210019</b>	Chisel Cartridge 0.2 x 0.1 mm 0.008 x 0.004 in		Package 01005, 0201 Very fine pitch 0.4 mm QFP, IC	Stations: CDS, CDES, DIU, DDU, DMU Tools: T210, T210P, T210N
	<b>C210023</b>	Chisel Cartridge 0.4 x 0.2 mm 0.016 x 0.008 in		Package 0402 Very fine pitch 0.65 mm QFP, IC	Stations: CDS, CDES, DIU, DDU, DMU Tools: T210, T210P, T210N
	<b>C210021</b>	Chisel Cartridge 0.6 x 0.3 mm 0.024 x 0.012 in		Package 0603	Stations: CDS, CDES, DIU, DDU, DMU Tools: T210, T210P, T210N
	<b>C210024</b>	Chisel Cartridge 0.8 x 0.3 mm 0.032 x 0.012 in		Package 0805 Through-hole	Stations: CDS, CDES, DIU, DDU, DMU Tools: T210, T210P, T210N
	<b>C210022</b>	Chisel Cartridge 1.3 x 0.4 mm 0.051 x 0.016 in		Package 0805 Through-hole	Stations: CDS, CDES, DIU, DDU, DMU Tools: T210, T210P, T210N

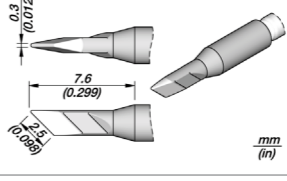
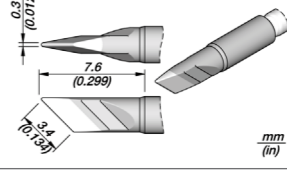
**C210 Cartridge Range for T210 Precision Handles**

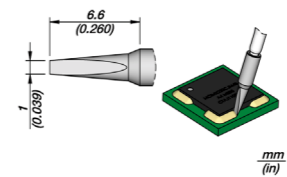
	Ref.	Description	Image and dimensions	Suggested components	Compatible with
	<b>C210008</b>	Chisel Cartridge 1.3 x 0.6 mm 0.051 x 0.024 in		Package 0805 Through-hole	Stations: CDS, CDES, DIU, DDU, DMU Tools: T210, T210P, T210N
	<b>C210007</b>	Chisel Cartridge 2.3 x 0.7 mm 0.091 x 0.028 in		Package 0805 Through-hole	Stations: CDS, CDES, DIU, DDU, DMU Tools: T210, T210P, T210N
	<b>C210017</b>	Pin Cartridge Ø 0.7 mm Ø 0.028 in		Through-hole	Stations: CDS, CDES, DIU, DDU, DMU Tools: T210, T210P, T210N
	<b>C210015</b>	Pin/Connector Cartridge Ø 0.8 mm Ø 0.032 in		Through-hole Coaxial connector	Stations: CDS, CDES, DIU, DDU, DMU Tools: T210, T210P, T210N
	<b>C210025</b>	Pin/Connector Cartridge Ø 1.1 mm Ø 0.043 in		Through-hole Coaxial connector	Stations: CDS, CDES, DIU, DDU, DMU Tools: T210, T210P, T210N
	<b>C210012</b>	Pin/Wire Cartridge Ø 1 mm Ø 0.039 in		Cables Connectors	Stations: CDS, CDES, DIU, DDU, DMU Tools: T210, T210P, T210N
	<b>C210033</b>	Knife Cartridge 2.5 x 0.3 mm 0.098 x 0.012 in		Drag soldering SMD SO, SOT Package 1210, 1812, 2010, 2512	Stations: CD, CDE, DIU, DDU, DMU Tools: T210, T210P, T210N
	<b>C210018</b>	Knife Cartridge 3.4 x 0.3 mm 0.134 x 0.012 in		Drag soldering SMD SO, SOT Package 1210, 1812, 2010, 2512	Stations: CDS, CDES, DIU, DDU, DMU Tools: T210, T210P, T210N
	<b>C210034</b>	Conformal Coating Removal Steel Cartridge 1 x 0.1 mm 0.039 x 0.004 in		Stainless Steel Remove underfill encapsulants	Stations: CDS, CDES, DIU, DDU, DMU Tools: T210, T210P, T210N



**C245 Cartridge Range**  
for T245 General Purpose Handles

Ref.	Description	Image and dimensions	Suggested components	Compatible with
<b>C245030</b>	Conical Cartridge Ø 0.3 mm Ø 0.012 in		Package 0201, 0402 Fine pitch 0.65 mm QFP, IC	Stations: CDB, CDEB, DIU, DDU, DMU Tools: T245, T245G, T245P, T245N
<b>C245032</b>	Conical Cartridge Ø 0.4 mm Ø 0.016 in		Package 0201, 0402 Fine pitch 0.65 mm QFP, IC	Stations: CDB, CDEB, DIU, DDU, DMU Tools: T245, T245G, T245P, T245N
<b>C245036</b>	Conical Cartridge Ø 0.5 mm S1 Ø 0.020 in		Package 0603 QFP, IC	Stations: CDB, CDEB, DIU, DDU, DMU Tools: T245, T245G, T245P, T245N
<b>C245930</b>	Conical Cartridge Ø 0.5 mm S2 Ø 0.020 in		Package 0603 QFP, IC	Stations: CDB, CDEB, DIU, DDU, DMU Tools: T245, T245G, T245P, T245N
<b>C245001</b>	Conical Cartridge Ø 0.6 mm Ø 0.024 in		Package 0603 QFP, IC	Stations: CDB, CDEB, DIU, DDU, DMU Tools: T245, T245G, T245P, T245N
<b>C245201</b>	Conical Cartridge Ø 0.6 mm L Ø 0.024 in		Package 0603 QFP, IC	Stations: CDB, CDEB, DIU, DDU, DMU Tools: T245, T245G, T245P, T245N
<b>C245937</b>	Conical Cartridge Ø 0.6 mm HT Ø 0.024 in		Package 0603 QFP, IC	Stations: CDB, CDEB, DIU, DDU, DMU Tools: T245, T245G, T245P, T245N



**C245 Cartridge Range for T245 General Purpose Handles**

Ref.	Description	Image and dimensions	Suggested components	Compatible with
<b>C245957</b>	Conical Cartridge Ø 0.8 mm Ø 0.031 in			Through-hole  Stations: CDB, CDEB, DIU, DDU, DMU Tools: T245, T245G, T245P, T245N
<b>C245903</b>	Conical Cartridge Ø 1 mm S1 Ø 0.040 in			General use  Stations: CDB, CDEB, DIU, DDU, DMU Tools: T245, T245G, T245P, T245N
<b>C245041</b>	Conical Cartridge Ø 1 mm S2 Ø 0.040 in			General use Tip with an extra tinned surface  Stations: CDB, CDEB, DIU, DDU, DMU Tools: T245, T245G, T245P, T245N
<b>C245803</b>	Conical Cartridge Ø 1 mm L Ø 0.040 in			General use  Stations: CDB, CDEB, DIU, DDU, DMU Tools: T245, T245G, T245P, T245N
<b>C245403</b>	Conical Cartridge Ø 1 HT mm Ø 0.040 in			General use  Stations: CDB, CDEB, DIU, DDU, DMU Tools: T245, T245G, T245P, T245N
<b>C245943</b>	Conical Cartridge Ø 1.7 mm Ø 0.070 in			General use  Stations: CDB, CDEB, DIU, DDU, DMU Tools: T245, T245G, T245P, T245N
<b>C245933</b>	Conical Cartridge Ø 2.2 mm Ø 0.090 in			General use  Stations: CDB, CDEB, DIU, DDU, DMU Tools: T245, T245G, T245P, T245N
<b>C245107</b>	Conical Cartridge Ø 3 mm HT Ø 0.118 in			General use  Stations: CDB, CDEB, DIU, DDU, DMU Tools: T245, T245G, T245P, T245N

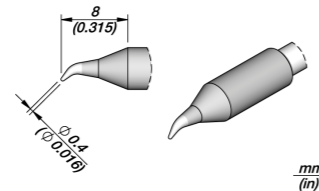
**C245 Cartridge Range for T245 General Purpose Handles**

	Ref.	Description	Image and dimensions	Suggested components	Compatible with
	<b>C245034</b>	Conical Bent Cartridge Ø 0.4 mm S1 Ø 0.016 in		Package 0201, 0402 Fine pitch 0.65 mm QFP, IC	Stations: CDB, CDEB, DIU, DDU, DMU Tools: T245, T245G, T245P, T245N
	<b>C245234</b>	Conical Bent Cartridge Ø 0.4 mm S1 L Ø 0.016 in		Package 0201, 0402 Fine pitch 0.65 mm QFP, IC	Stations: CDB, CDEB, DIU, DDU, DMU Tools: T245, T245G, T245P, T245N
	<b>C245029</b>	Conical Bent Cartridge Ø 0.4 mm S2 Ø 0.016 in		Package 0201, 0402 Fine pitch 0.65 mm QFP, IC	Stations: CDB, CDEB, DIU, DDU, DMU Tools: T245, T245G, T245P, T245N
	<b>C245126</b>	Conical Bent Cartridge Ø 0.4 mm S3 Ø 0.016 in		Package 0201, 0402 Fine pitch 0.65 mm QFP, IC	Stations: CDB, CDEB, DIU, DDU, DMU Tools: T245, T245G, T245P, T245N
	<b>C245786</b>	Conical Bent Cartridge Ø 0.4 mm S4 Ø 0.016 in		Package 0201, 0402 Fine pitch 0.65 mm QFP, IC	Stations: CDB, CDEB, DIU, DDU, DMU Tools: T245, T245G, T245P, T245N
	<b>C245929</b>	Conical Bent Cartridge Ø 0.6 mm Ø 0.024 in		Package 0603 QFP, IC	Stations: CDB, CDEB, DIU, DDU, DMU Tools: T245, T245G, T245P, T245N
	<b>C245935</b>	Conical Bent Cartridge Ø 0.8 mm Ø 0.031 in		Through-hole	Stations: CDB, CDEB, DIU, DDU, DMU Tools: T245, T245G, T245P, T245N
	<b>C245904</b>	Conical Bent Cartridge Ø 1 mm Ø 0.039 in		General use	Stations: CDB, CDEB, DIU, DDU, DMU Tools: T245, T245G, T245P, T245N

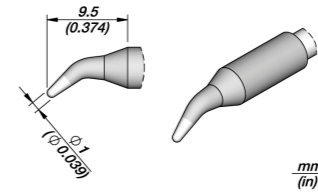
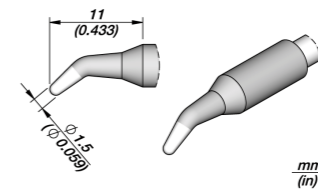
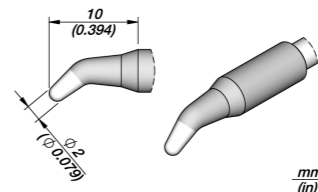
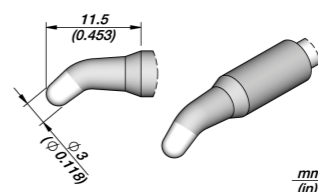
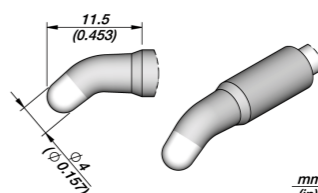
**C245 Cartridge Range for T245 General Purpose Handles**

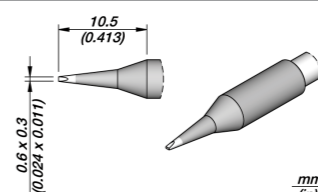
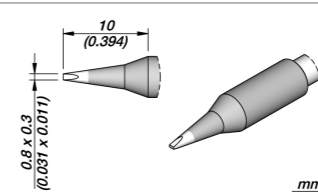
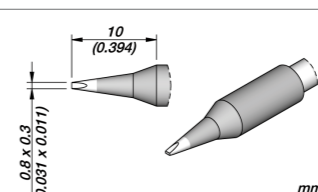
	Ref.	Description	Image and dimensions	Suggested components	Compatible with
	<b>C245804</b>	Conical Bent Cartridge Ø 1 mm L Ø 0.039 in		General use	Stations: CDB, CDEB, DIU, DDU, DMU Tools: T245, T245G, T245P, T245N
	<b>C245259</b>	Conical Bent Cartridge Ø 1.5 mm Ø 0.059 in		General use	Stations: CDB, CDEB, DIU, DDU, DMU Tools: T245, T245G, T245P, T245N
	<b>C245260</b>	Conical Bent Cartridge Ø 2 mm HT Ø 0.079 in		General use	Stations: CDB, CDEB, DIU, DDU, DMU Tools: T245, T245G, T245P, T245N
	<b>C245627</b>	Conical Bent Cartridge Ø 3 mm Ø 0.118 in		General use	Stations: CDB, CDEB, DIU, DDU, DMU Tools: T245, T245G, T245P, T245N
	<b>C245628</b>	Conical Bent Cartridge Ø 4 mm HT Ø 0.157 in		General use	Stations: CDB, CDEB, DIU, DDU, DMU Tools: T245, T245G, T245P, T245N
	<b>C245731</b>	Chisel Cartridge 0.6 x 0.3 mm 0.024 x 0.011 in		Package 0603	Stations: CDB, CDEB, DIU, DDU, DMU Tools: T245, T245G, T245P, T245N
	<b>C245773</b>	Chisel Cartridge 0.8 x 0.3 mm 0.031 x 0.011 in		Package 0805 Through-hole	Stations: CDB, CDEB, DIU, DDU, DMU Tools: T245, T245G, T245P, T245N
	<b>C245673</b>	Chisel Cartridge 0.8 x 0.3 mm L 0.031 x 0.011 in		Package 0805 Through-hole	Stations: CDB, CDEB, DIU, DDU, DMU Tools: T245, T245G, T245P, T245N

**C245 Cartridge Range for T245 General Purpose Handles**

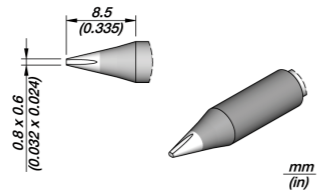
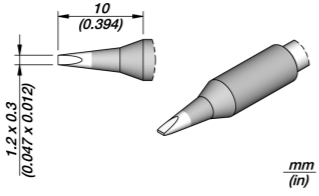
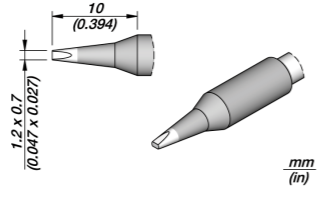
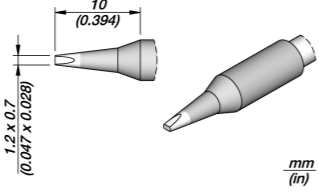
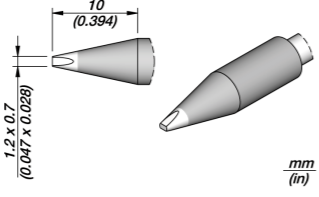
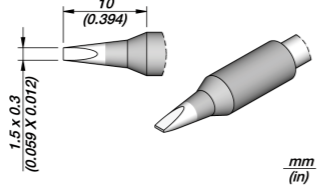
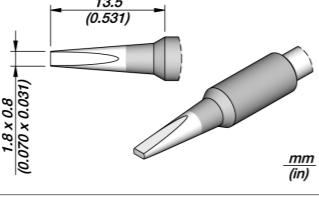
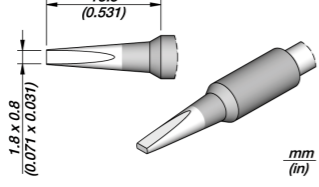
Ref.	Description	Image and dimensions	Suggested components	Compatible with
<b>C245742</b>	Chisel Cartridge 0.8 x 0.6 mm HT 0.032 x 0.024 in		Package 0805 Through-hole	Stations: CDB, CDEB, DIU, DDU, DMU Tools: T245, T245G, T245P, T245N
<b>C245774</b>	Chisel Cartridge 1.2 x 0.3 mm 0.047 x 0.012 in		General use	Stations: CDB, CDEB, DIU, DDU, DMU Tools: T245, T245G, T245P, T245N
<b>C245906</b>	Chisel Cartridge 1.2 x 0.7 mm 0.047 x 0.027 in		General use	Stations: CDB, CDEB, DIU, DDU, DMU Tools: T245, T245G, T245P, T245N
<b>C245806</b>	Chisel Cartridge 1.2 x 0.7 mm L 0.047 x 0.028 in		General use	Stations: CDB, CDEB, DIU, DDU, DMU Tools: T245, T245G, T245P, T245N
<b>C245406</b>	Chisel Cartridge 1.2 x 0.7 mm HT 0.047 x 0.028 in		General use	Stations: CDB, CDEB, DIU, DDU, DMU Tools: T245, T245G, T245P, T245N
<b>C245768</b>	Chisel Cartridge 1.5 x 0.3 mm 0.059 x 0.012 in		General use	Stations: CDB, CDEB, DIU, DDU, DMU Tools: T245, T245G, T245P, T245N
<b>C245944</b>	Chisel Cartridge 1.8 x 0.8 mm 0.070 x 0.031 in		General use	Stations: CDB, CDEB, DIU, DDU, DMU Tools: T245, T245G, T245P, T245N
<b>C245844</b>	Chisel Cartridge 1.8 x 0.8 mm L 0.071 x 0.031 in		General use	Stations: CDB, CDEB, DIU, DDU, DMU Tools: T245, T245G, T245P, T245N

**C245 Cartridge Range for T245 General Purpose Handles**

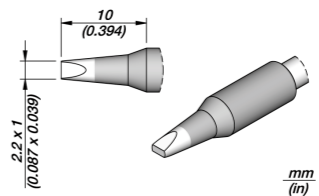
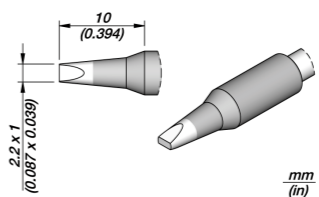
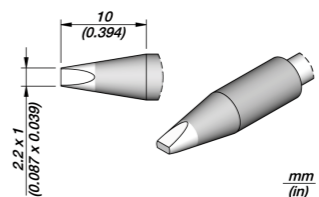
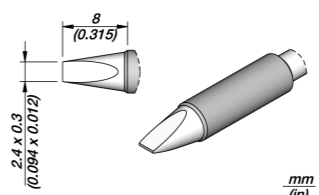
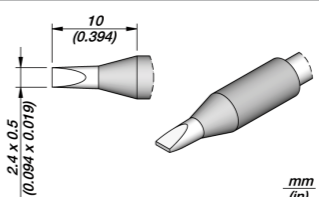
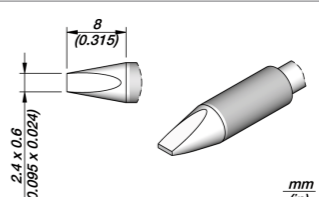
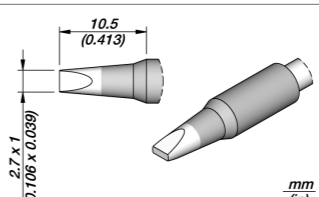
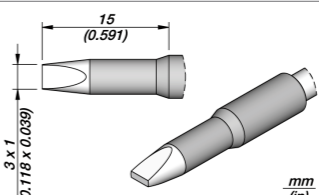
Ref.	Description	Image and dimensions	Suggested components	Compatible with
<b>C245907</b>	Chisel Cartridge 2.2 x 1 mm 0.087 x 0.039 in		General use	Stations: CDB, CDEB, DIU, DDU, DMU Tools: T245, T245G, T245P, T245N
<b>C245807</b>	Chisel Cartridge 2.2 x 1 mm L 0.087 x 0.039 in		General use	Stations: CDB, CDEB, DIU, DDU, DMU Tools: T245, T245G, T245P, T245N
<b>C245407</b>	Chisel Cartridge 2.2 x 1 mm HT 0.087 x 0.039 in		General use	Stations: CDB, CDEB, DIU, DDU, DMU Tools: T245, T245G, T245P, T245N
<b>C245770</b>	Chisel Cartridge 2.4 x 0.3 mm 0.094 x 0.012 in		General use	Stations: CDB, CDEB, DIU, DDU, DMU Tools: T245, T245G, T245P, T245N
<b>C245759</b>	Chisel Cartridge 2.4 x 0.5 mm HT 0.094 x 0.019 in		General use	Stations: CDB, CDEB, DIU, DDU, DMU Tools: T245, T245G, T245P, T245N
<b>C245741</b>	Chisel Cartridge 2.4 x 0.6 mm HT 0.095 x 0.024 in		General use	Stations: CDB, CDEB, DIU, DDU, DMU Tools: T245, T245G, T245P, T245N
<b>C245729</b>	Chisel Cartridge 2.7 x 1 mm 0.106 x 0.039 in		General use	Stations: CDB, CDEB, DIU, DDU, DMU Tools: T245, T245G, T245P, T245N
<b>C245061</b>	Chisel Cartridge 3 x 1 mm 0.118 x 0.039 in		General use	Stations: CDB, CDEB, DIU, DDU, DMU Tools: T245, T245G, T245P, T245N

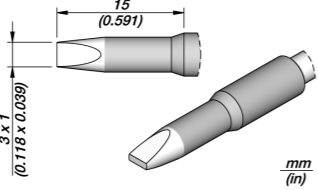
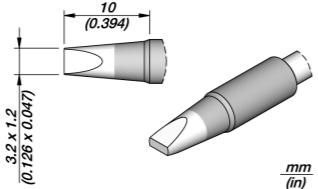
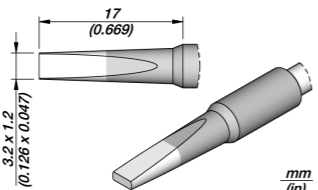
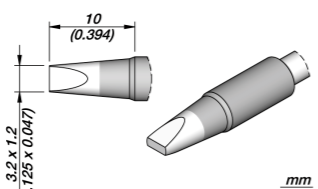
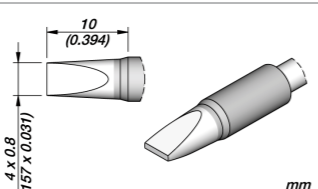
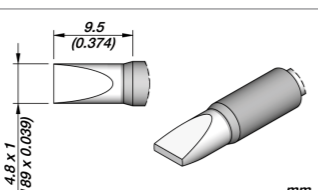
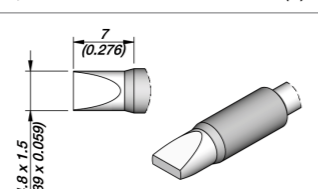
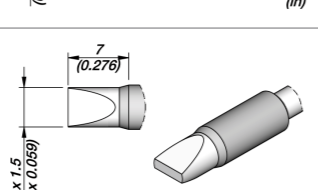

**C245 Cartridge Range for T245 General Purpose Handles**

Ref.	Description	Image and dimensions	Suggested components	Compatible with
<b>C245261</b>	Chisel Cartridge 3 x 1 mm L 0.118 x 0.039 in		General use	Stations: CDB, CDEB, DIU, DDU, DMU Tools: T245, T245G, T245P, T245N
<b>C245911</b>	Chisel Cartridge 3.2 x 1.2 mm 0.126 x 0.047 in		General use	Stations: CDB, CDEB, DIU, DDU, DMU Tools: T245, T245G, T245P, T245N
<b>C245775</b>	Chisel Cartridge 3.2 x 1.2 mm S1 0.126 x 0.047 in		General use	Stations: CDB, CDEB, DIU, DDU, DMU Tools: T245, T245G, T245P, T245N
<b>C245811</b>	Chisel Cartridge 3.2 x 1.2 mm L 0.125 x 0.047 in		General use	Stations: CDB, CDEB, DIU, DDU, DMU Tools: T245, T245G, T245P, T245N
<b>C245755</b>	Chisel Cartridge 4 x 0.8 mm HT 0.157 x 0.031 in		General use	Stations: CDB, CDEB, DIU, DDU, DMU Tools: T245, T245G, T245P, T245N
<b>C245756</b>	Chisel Cartridge 4.8 x 1 mm HT 0.189 x 0.374 in		General use	Stations: CDB, CDEB, DIU, DDU, DMU Tools: T245, T245G, T245P, T245N
<b>C245908</b>	Chisel Cartridge 4.8 x 1.5 mm HT S1 0.189 x 0.059 in		General use	Stations: CDB, CDEB, DIU, DDU, DMU Tools: T245, T245G, T245P, T245N
<b>C245808</b>	Chisel Cartridge 4.8 x 1.5 mm HT L 0.189 x 0.059 in		General use	Stations: CDB, CDEB, DIU, DDU, DMU Tools: T245, T245G, T245P, T245N

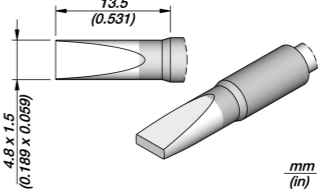
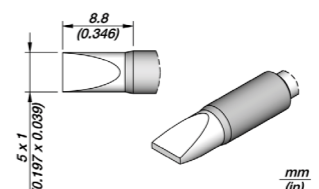
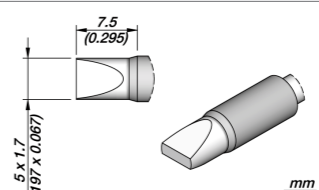
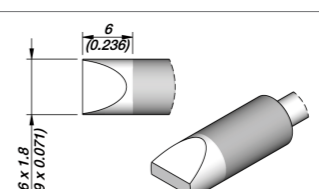
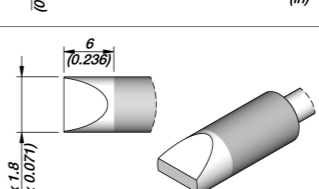
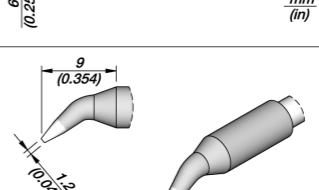
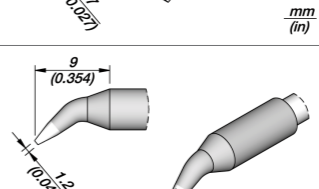
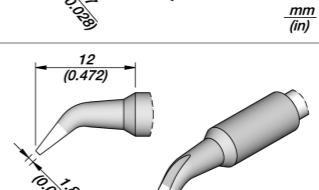
**C245 Cartridge Range for T245 General Purpose Handles**

Ref.	Description	Image and dimensions	Suggested components	Compatible with
<b>C245708</b>	Chisel Cartridge 4.8 x 1.5 mm HT S2 0.189 x 0.059 in		General use	Stations: CDB, CDEB, DIU, DDU, DMU Tools: T245, T245G, T245P, T245N
<b>C245967</b>	Chisel Cartridge 5 x 1 mm HT 0.197 x 0.039 in		General use	Stations: CDB, CDEB, DIU, DDU, DMU Tools: T245, T245G, T245P, T245N
<b>C245069</b>	Chisel Cartridge 5 x 1.7 mm HT 0.197 x 0.067 in		General use	Stations: CDB, CDEB, DIU, DDU, DMU Tools: T245, T245G, T245P, T245N
<b>C245966</b>	Chisel Cartridge 6.6 x 1.8 mm HT 0.259 x 0.071 in		General use	Stations: CDB, CDEB, DIU, DDU, DMU Tools: T245, T245G, T245P, T245N
<b>C245866</b>	Chisel Cartridge 6.6 x 1.8 mm HT L 0.259 x 0.071 in		General use	Stations: CDB, CDEB, DIU, DDU, DMU Tools: T245, T245G, T245P, T245N
<b>C245962</b>	Chisel Bent Cartridge 1.2 x 0.7 mm 0.047 x 0.027 in		General use	Stations: CDB, CDEB, DIU, DDU, DMU Tools: T245, T245G, T245P, T245N
<b>C245862</b>	Chisel Bent Cartridge 1.2 x 0.7 mm L 0.047 x 0.028 in		General use	Stations: CDB, CDEB, DIU, DDU, DMU Tools: T245, T245G, T245P, T245N
<b>C245963</b>	Chisel Bent Cartridge 1.8 x 0.8 mm 0.071 x 0.031 in		General use	Stations: CDB, CDEB, DIU, DDU, DMU Tools: T245, T245G, T245P, T245N

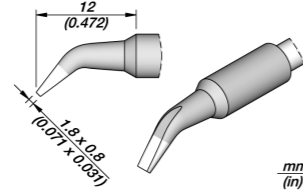
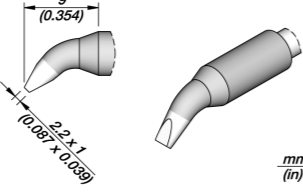
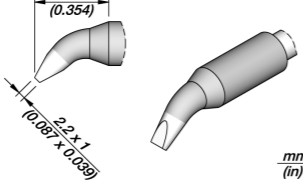
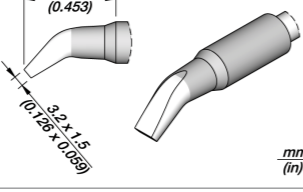
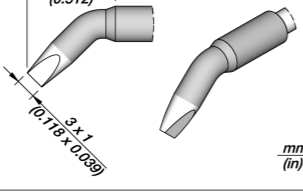
**C245 Cartridge Range for T245 General Purpose Handles**

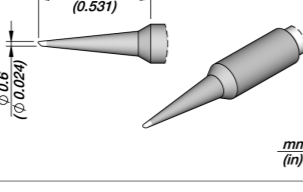
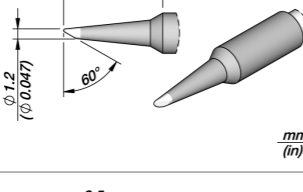
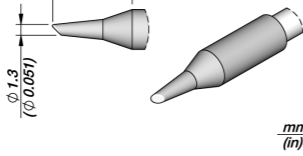
	Ref.	Description	Image and dimensions	Suggested components	Compatible with
	<b>C245863</b>	Chisel Bent Cartridge 1.8 x 0.8 mm L 0.071 x 0.031 in		General use	Stations: CDB, CDEB, DIU, DDU, DMU Tools: T245, T245G, T245P, T245N
	<b>C245946</b>	Chisel Bent Cartridge 2.2 x 1 mm 0.087 x 0.039 in		General use	Stations: CDB, CDEB, DIU, DDU, DMU Tools: T245, T245G, T245P, T245N
	<b>C245846</b>	Chisel Bent Cartridge 2.2 x 1 mm L 0.087 x 0.039 in		General use	Stations: CDB, CDEB, DIU, DDU, DMU Tools: T245, T245G, T245P, T245N
	<b>C245732</b>	Chisel Bent Cartridge 3.2 x 1.5 mm 0.126 x 0.059 in		General use	Stations: CDB, CDEB, DIU, DDU, DMU Tools: T245, T245G, T245P, T245N
	<b>C245761</b>	Chisel Bent Cartridge 3 x 1 mm 0.118 x 0.039 in		General use	Stations: CDB, CDEB, DIU, DDU, DMU Tools: T245, T245G, T245P, T245N
	<b>C245747</b>	Bevel Cartridge Ø 0.6 mm Ø 0.024 in		Package 0603 Through-hole	Stations: CDB, CDEB, DIU, DDU, DMU Tools: T245, T245G, T245P, T245N
	<b>C245710</b>	Bevel Cartridge Ø 1.2 mm Ø 0.047 in		Drag soldering Through-hole	Stations: CDB, CDEB, DIU, DDU, DMU Tools: T245, T245G, T245P, T245N
	<b>C245064</b>	Bevel Cartridge Ø 1.3 mm Ø 0.051 in		Drag soldering Through-hole Hoof tip with reduced tinned surface, ideal for touch-up	Stations: CDB, CDEB, DIU, DDU, DMU Tools: T245, T245G, T245P, T245N

**C245 Cartridge Range for T245 General Purpose Handles**

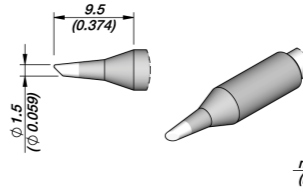
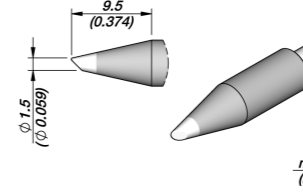
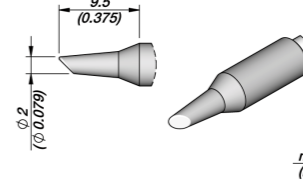
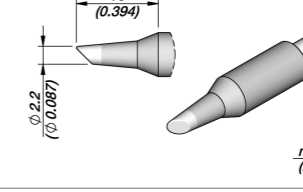
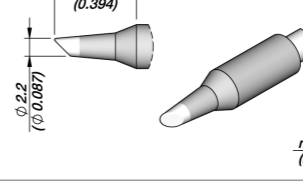
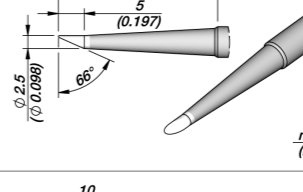
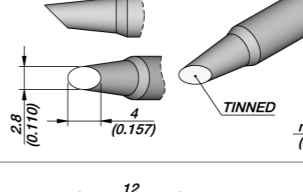
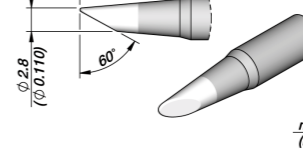



	Ref.	Description	Image and dimensions	Suggested components	Compatible with
	<b>C245905</b>	Bevel Cartridge Ø 1.5 mm Ø 0.059 in		Drag soldering Through-hole	Stations: CDB, CDEB, DIU, DDU, DMU Tools: T245, T245G, T245P, T245N
	<b>C245405</b>	Bevel Cartridge Ø 1.5 mm HT Ø 0.059 in		Drag soldering Through-hole	Stations: CDB, CDEB, DIU, DDU, DMU Tools: T245, T245G, T245P, T245N
	<b>C245102</b>	Bevel Cartridge Ø 2 mm Ø 0.079 in		Drag soldering Through-hole Hoof tip with reduced tinned surface, ideal for touch-up	Stations: CDB, CDEB, DIU, DDU, DMU Tools: T245, T245G, T245P, T245N
	<b>C245945</b>	Bevel Cartridge Ø 2.2 mm Ø 0.087 in		Drag soldering Through-hole	Stations: CDB, CDEB, DIU, DDU, DMU Tools: T245, T245G, T245P, T245N
	<b>C245845</b>	Bevel Cartridge Ø 2.2 mm L Ø 0.087 in		Drag soldering Through-hole	Stations: CDB, CDEB, DIU, DDU, DMU Tools: T245, T245G, T245P, T245N
	<b>C245795</b>	Bevel Cartridge Ø 2.5 mm L Ø 0.098 in		Drag soldering Through-hole	Stations: CDB, CDEB, DIU, DDU, DMU Tools: T245, T245G, T245P, T245N
	<b>C245784</b>	Bevel Cartridge Ø 2.8 mm Ø 0.110 in		Drag soldering Through-hole	Stations: CDB, CDEB, DIU, DDU, DMU Tools: T245, T245G, T245P, T245N
	<b>C245793</b>	Bevel Cartridge Ø 2.8 mm - 60° Ø 0.110 in - 60°		Drag soldering Through-hole	Stations: CDB, CDEB, DIU, DDU, DMU Tools: T245, T245G, T245P, T245N

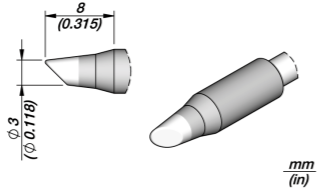
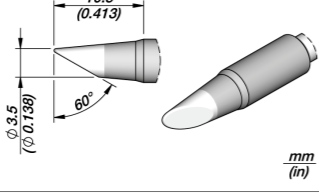
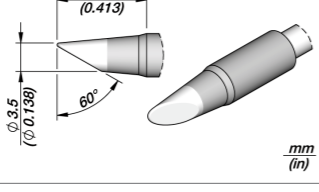
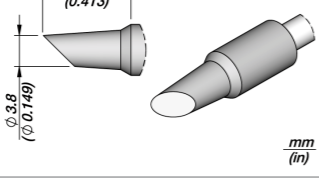
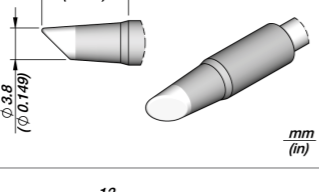
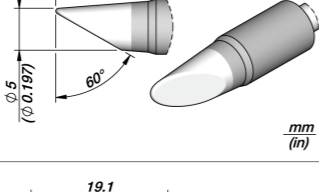
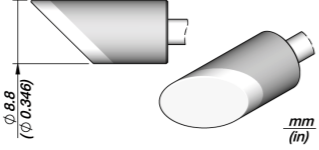



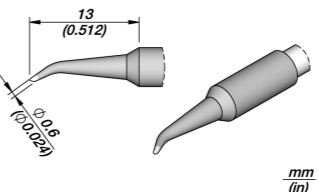
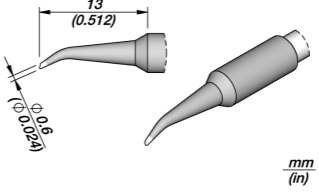

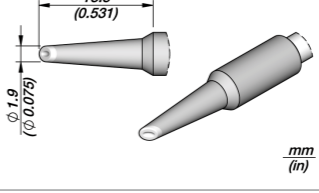
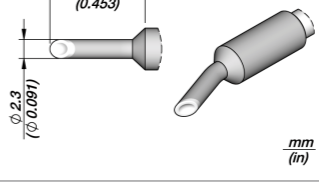
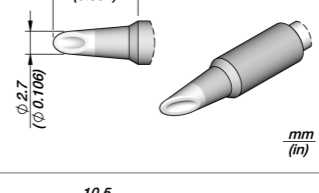
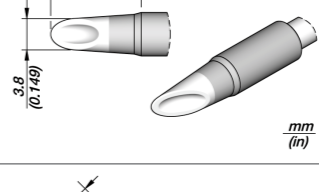
**C245 Cartridge Range for T245 General Purpose Handles**

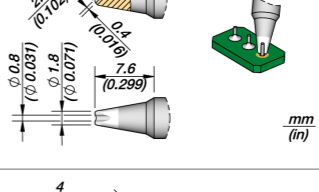
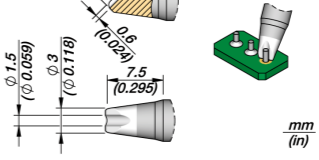
	Ref.	Description	Image and dimensions	Suggested components	Compatible with
	<b>C245912</b>	Bevel Cartridge Ø 3 mm Ø 0.118 in		Drag soldering Through-hole	Stations: CDB, CDEB, DIU, DDU, DMU Tools: T245, T245G, T245P, T245N
	<b>C245812</b>	Bevel Cartridge Ø 3 mm L Ø 0.118 in		Drag soldering Through-hole	Stations: CDB, CDEB, DIU, DDU, DMU Tools: T245, T245G, T245P, T245N
	<b>C245056</b>	Bevel Cartridge Ø 3.5 mm HT Ø 0.138 in		Drag soldering Through-hole	Stations: CDB, CDEB, DIU, DDU, DMU Tools: T245, T245G, T245P, T245N
	<b>C245256</b>	Bevel Cartridge Ø 3.5 mm HT L Ø 0.138 in		Drag soldering Through-hole	Stations: CDB, CDEB, DIU, DDU, DMU Tools: T245, T245G, T245P, T245N
	<b>C245797</b>	Bevel Cartridge Ø 3.8 mm Ø 0.149 in		Hoof Tip with reduced tinned surface, ideal for touch-up	Stations: CDB, CDEB, DIU, DDU, DMU Tools: T245, T245G, T245P, T245N
	<b>C245951</b>	Bevel Cartridge Ø 3.8 mm HT Ø 0.149 in		Drag soldering Through-hole	Stations: CDB, CDEB, DIU, DDU, DMU Tools: T245, T245G, T245P, T245N
	<b>C245766</b>	Bevel Cartridge Ø 5 mm Ø 0.197 in		Wide area	Stations: CDB, CDEB, DIU, DDU, DMU Tools: T245, T245G, T245P, T245N
	<b>C245301</b>	Bevel Cartridge Ø 8 mm Ø 0.346 in		Wide area	Stations: CDB, CDEB, DIU, DDU, DMU Tools: T245, T245G, T245P, T245N

**C245 Cartridge Range for T245 General Purpose Handles**

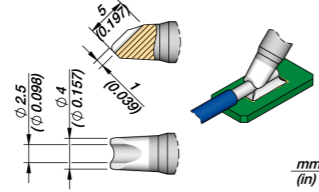
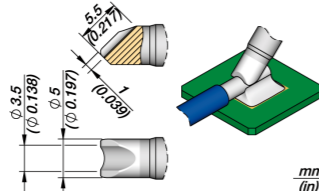
	Ref.	Description	Image and dimensions	Suggested components	Compatible with
	<b>C245748</b>	Bevel Bent Cartridge Ø 0.6 mm S1 Ø 0.024 in		Package 0603 Through-hole	Stations: CDB, CDEB, DIU, DDU, DMU Tools: T245, T245G, T245P, T245N
	<b>C245749</b>	Bevel Bent Cartridge Ø 0.6 mm S2 Ø 0.024 in		Package 0603 Through-hole	Stations: CDB, CDEB, DIU, DDU, DMU Tools: T245, T245G, T245P, T245N
	<b>C245965</b>	Spoon Cartridge Ø 1.9 mm Ø 0.075 in		Drag soldering	Stations: CDB, CDEB, DIU, DDU, DMU Tools: T245, T245G, T245P, T245N
	<b>C245067</b>	Spoon Cartridge Ø 2.3 mm Ø 0.091 in		Drag soldering	Stations: CDB, CDEB, DIU, DDU, DMU Tools: T245, T245G, T245P, T245N
	<b>C245931</b>	Spoon Cartridge Ø 2.7 mm Ø 0.106 in		Drag soldering	Stations: CDB, CDEB, DIU, DDU, DMU Tools: T245, T245G, T245P, T245N
	<b>C245938</b>	Spoon Cartridge Ø 3.8 mm Ø 0.149 in		Drag soldering	Stations: CDB, CDEB, DIU, DDU, DMU Tools: T245, T245G, T245P, T245N
	<b>C245790</b>	Barrel Cartridge Ø 0.8 mm Ø 0.031 in		Through-hole Cable sold/desol	Stations: CDB, CDEB, DIU, DDU, DMU Tools: T245, T245G, T245P, T245N
	<b>C245785</b>	Barrel Cartridge Ø 1.5 mm Ø 0.059 in		Through-hole Cable sold/desol	Stations: CDB, CDEB, DIU, DDU, DMU Tools: T245, T245G, T245P, T245N

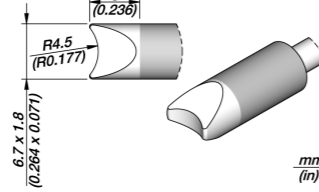
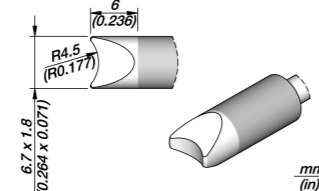
**C245 Cartridge Range for T245 General Purpose Handles**

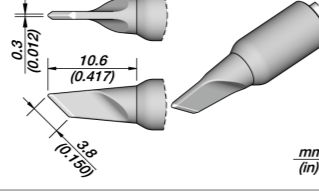
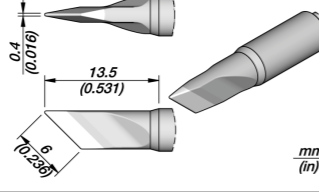
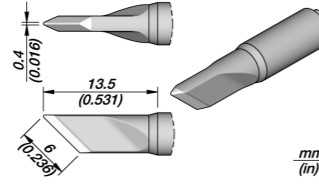
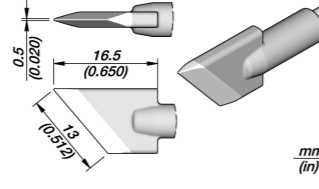
	Ref.	Description	Image and dimensions	Suggested components	Compatible with
	<b>C245763</b>	Pin/Connector Cartridge Ø 2.5 mm Ø 0.098 in		Through-hole Cable sold/desol	Stations: CDB, CDEB, DIU, DDU, DMU Tools: T245, T245G, T245P, T245N
	<b>C245760</b>	Pin/Connector Cartridge Ø 3.5 mm Ø 0.138 in		Through-hole Cable sold/desol	Stations: CDB, CDEB, DIU, DDU, DMU Tools: T245, T245G, T245P, T245N
	<b>C245762</b>	Pin/Connector Cartridge R. 4.5 mm R. 0.177 in		Cable sold/desol	Stations: CDB, CDEB, DIU, DDU, DMU Tools: T245, T245G, T245P, T245N
	<b>C245662</b>	Round Connector Cartridge R. 4.5 mm L R. 0.177 in		Cable sold/desol	Stations: CDB, CDEB, DIU, DDU, DMU Tools: T245, T245G, T245P, T245N
	<b>C245789</b>	Knife Cartridge 3.8 x 0.3 mm 0.150 x 0.012 in		Drag soldering	Stations: CDB, CDEB, DIU, DDU, DMU Tools: T245, T245G, T245P, T245N
	<b>C245939</b>	Knife Cartridge 6.0 x 0.4 mm 0.236 x 0.016 in		Drag soldering	Stations: CDB, CDEB, DIU, DDU, DMU Tools: T245, T245G, T245P, T245N
	<b>C245765</b>	Knife Cartridge 6.0 x 0.4 mm S1 0.236 x 0.016 in		Drag soldering	Stations: CDB, CDEB, DIU, DDU, DMU Tools: T245, T245G, T245P, T245N
	<b>C245955</b>	Knife Cartridge 13 x 0.5 mm 0.512 x 0.020 in		Drag Soldering Connector desoldering	Stations: CDB, CDEB, DIU, DDU, DMU Tools: T245, T245G, T245P, T245N

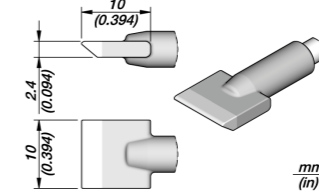
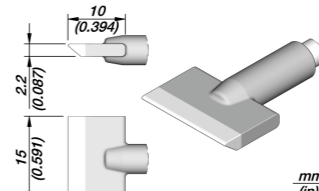
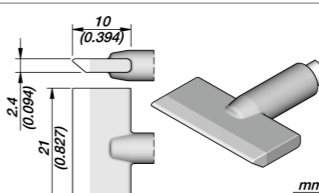
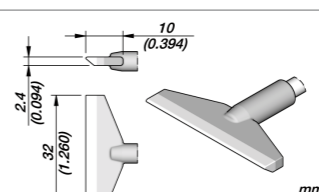
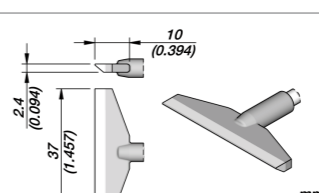
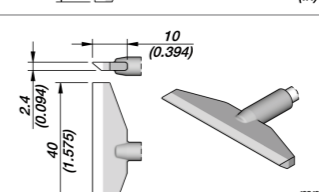
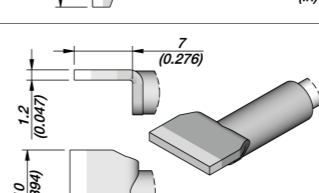
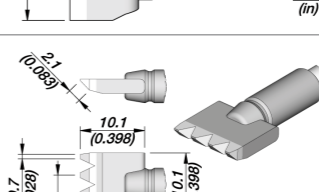

**C245 Cartridge Range for T245 General Purpose Handles**

	Ref.	Description	Image and dimensions	Suggested components	Compatible with
	<b>C245914</b>	Blade Cartridge 10 mm S1 0.394 in		Pad cleaning Connector desoldering	Stations: CDB, CDEB, DIU, DDU, DMU Tools: T245, T245G, T245P, T245N
	<b>C245752</b>	Blade Cartridge 15 mm 0.591 in		Pad cleaning Connector desoldering	Stations: CDB, CDEB, DIU, DDU, DMU Tools: T245, T245G, T245P, T245N
	<b>C245913</b>	Blade Cartridge 21 mm 0.827 in		Pad cleaning Connector desoldering	Stations: CDB, CDEB, DIU, DDU, DMU Tools: T245, T245G, T245P, T245N
	<b>C245949</b>	Blade Cartridge 32 mm 1.260 in		Pad cleaning Connector desoldering	Stations: CDB, CDEB, DIU, DDU, DMU Tools: T245, T245G, T245P, T245N
	<b>C245776</b>	Blade Cartridge 37 mm 1.457 in		Pad cleaning Connector desoldering	Stations: CDB, CDEB, DIU, DDU, DMU Tools: T245, T245G, T245P, T245N
	<b>C245792</b>	Blade Cartridge 40 mm 1.575 in		Pad cleaning Connector desoldering	Stations: CDB, CDEB, DIU, DDU, DMU Tools: T245, T245G, T245P, T245N
	<b>C245730</b>	Blade Cartridge 10 mm S2 0.394 in		Pad cleaning Connector desoldering	Stations: CDB, CDEB, DIU, DDU, DMU Tools: T245, T245G, T245P, T245N
	<b>C245728</b>	Multipad Blade Cartridge 10.1 mm 0.398 in		Connector sold / desold	Stations: CDB, CDEB, DIU, DDU, DMU Tools: T245, T245G, T245P, T245N

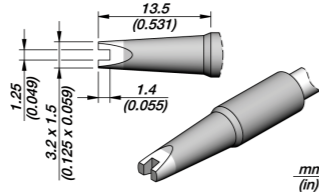
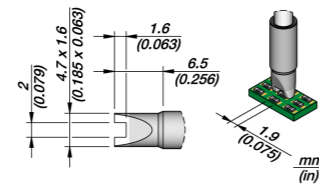
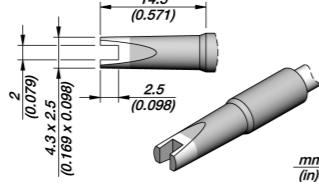
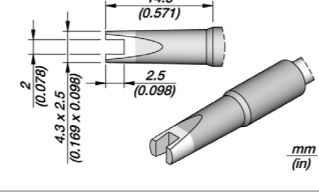
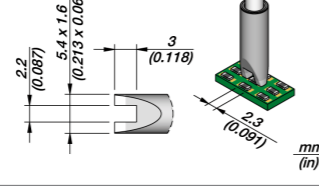
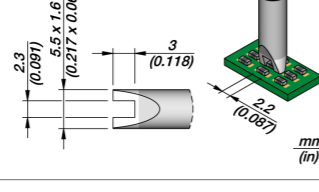
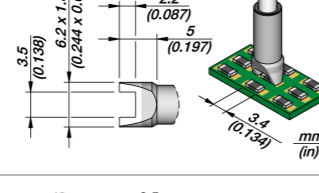
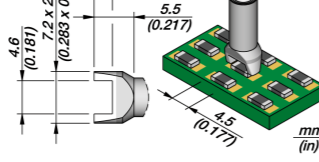
**C245 Cartridge Range for T245 General Purpose Handles**

Ref.	Description	Image and dimensions	Suggested components	Compatible with
 <b>C245757</b>	Chip Cartridge 1.25 mm 0.049 in		SMD resistors SMD capacitors	Stations: CDB, CDEB, DIU, DDU, DMU Tools: T245, T245G, T245P, T245N
<b>C245016</b>	Chip Cartridge 1.9 mm 0.075 in		SMD resistors SMD capacitors	Stations: CDB, CDEB, DIU, DDU, DMU Tools: T245, T245G, T245P, T245N
<b>C245758</b>	Chip Cartridge 2 mm 0.079 in		SMD resistors SMD capacitors	Stations: CDB, CDEB, DIU, DDU, DMU Tools: T245, T245G, T245P, T245N
<b>C245658</b>	Chip Cartridge 2.0 mm L 0.078 in		SMD resistors SMD capacitors	Stations: CDB, CDEB, DIU, DDU, DMU Tools: T245, T245G, T245P, T245N
<b>C245017</b>	Chip Cartridge 2.3 mm S1 0.091 in		SMD resistors SMD capacitors	Stations: CDB, CDEB, DIU, DDU, DMU Tools: T245, T245G, T245P, T245N
<b>C245150</b>	Chip Cartridge 2.2 mm S2 0.087 in		SMD resistors SMD capacitors	Stations: CDB, CDEB, DIU, DDU, DMU Tools: T245, T245G, T245P, T245N
<b>C245018</b>	Chip Cartridge 3.4 mm 0.134 in		SMD resistors SMD capacitors	Stations: CD, CDE, DIU, DDU, DMU Tools: T245, T245G, T245P, T245N
<b>C245019</b>	Chip Cartridge 4.5 mm 0.177 in		SMD resistors SMD capacitors	Stations: CDB, CDEB, DIU, DDU, DMU Tools: T245 handles: T245, T245G, T245P, T245N

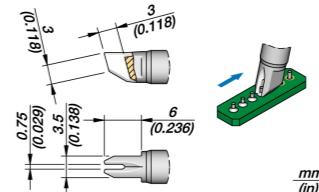
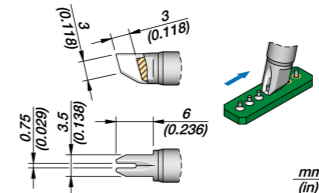
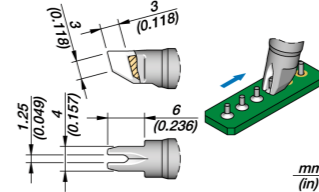
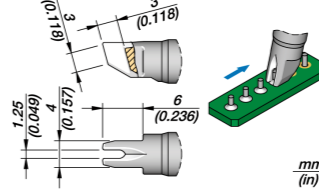
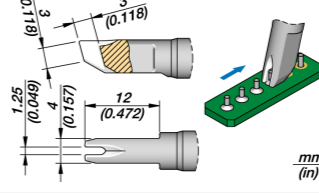
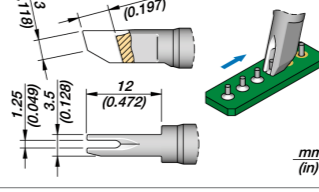
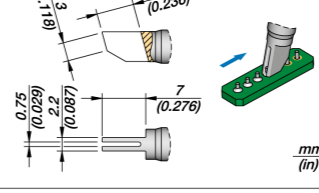
**C245 Cartridge Range for T245 General Purpose Handles**

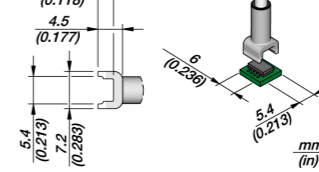
Ref.	Description	Image and dimensions	Suggested components	Compatible with
 <b>C245754</b>	Drag Cartridge 0.75 mm 0.029 in		Drag soldering	Stations: CDB, CDEB, DIU, DDU, DMU Tools: T245, T245G, T245P, T245N
<b>C245654</b>	Drag Cartridge 0.75 mm L 0.029 in		Drag soldering	Stations: CDB, CDEB, DIU, DDU, DMU Tools: T245, T245G, T245P, T245N
<b>C245751</b>	Drag Cartridge 1.25 mm 0.049 in		Drag soldering	Stations: CDB, CDEB, DIU, DDU, DMU Tools: T245, T245G, T245P, T245N
<b>C245651</b>	Drag Cartridge 1.25 mm L 0.049 in		Drag soldering	Stations: CDB, CDEB, DIU, DDU, DMU Tools: T245, T245G, T245P, T245N
<b>C245667</b>	Drag Cartridge 1.25 mm S1 L 0.049 in		Drag soldering	Stations: CDB, CDEB, DIU, DDU, DMU Tools: T245, T245G, T245P, T245N
<b>C245669</b>	Drag Cartridge 1.25 mm S2 L 0.049 in		Drag soldering	Stations: CDB, CDEB, DIU, DDU, DMU Tools: T245, T245G, T245P, T245N
<b>C245796</b>	Drag Cartridge 2.2 x 0.75 mm 0.087 x 0.029 in		Drag soldering	Stations: CDB, CDEB, DIU, DDU, DMU Tools: T245, T245G, T245P, T245N
 <b>C245220</b>	Tunnel Cartridge 5.4 x 6 mm 0.213 x 0.236 in		Dual in Line IC	Stations: CDB, CDEB, DIU, DDU, DMU Tools: T245, T245G, T245P, T245N

**C245 Cartridge Range for T245 General Purpose Handles**

Ref.	Description	Image and dimensions	Suggested components	Compatible with
<b>C245250</b>	Tunnel Cartridge 5.4 x 8 mm 0.213 x 0.315 in		Dual in Line IC	Stations: CDB, CDEB, DIU, DDU, DMU Tools: T245, T245G, T245P, T245N
<b>C245221</b>	Tunnel Cartridge 5.4 x 10 mm 0.213 x 0.394 in		Dual in Line IC	Stations: CDB, CDEB, DIU, DDU, DMU Tools: T245, T245G, T245P, T245N
<b>C245303</b>	Tunnel Cartridge 6.5 x 6 mm 0.256 x 0.236 in		Dual in Line IC	Stations: CDB, CDEB, DIU, DDU, DMU Tools: T245, T245G, T245P, T245N
<b>C245222</b>	Tunnel Cartridge 7.1 x 13 mm 0.279 x 0.512 in		Dual in Line IC	Stations: CDB, CDEB, DIU, DDU, DMU Tools: T245, T245G, T245P, T245N
<b>C245306</b>	Tunnel Cartridge 9.6 x 10 mm 0.378 x 0.394 in		Dual in Line IC	Stations: CDB, CDEB, DIU, DDU, DMU Tools: T245, T245G, T245P, T245N
<b>C245305</b>	Tunnel Cartridge 9.6 x 12 mm 0.378 x 0.472 in		Dual in Line IC	Stations: CDB, CDEB, DIU, DDU, DMU Tools: T245, T245G, T245P, T245N
<b>C245304</b>	Tunnel Cartridge 9.6 x 15 mm 0.378 x 0.591 in		Dual in Line, IC	Stations: CD, CDE, DIU, DDU, DMU Tools: T245, T245G, T245P, T245N
<b>C245215</b>	Tunnel Cartridge 9.6 x 18 mm 0.378 x 0.709 in		Dual in Line IC	Stations: CDB, CDEB, DIU, DDU, DMU Tools: T245, T245G, T245P, T245N

**C245 Cartridge Range for T245 General Purpose Handles**

Ref.	Description	Image and dimensions	Suggested components	Compatible with
<b>C245226</b>	Tunnel Cartridge 15.2 x 29 mm 0.598 x 1.142 in		Dual in Line IC	Stations: CDB, CDEB, DIU, DDU, DMU Tools: T245, T245G, T245P, T245N
<b>C245223</b>	QFP Cartridge 8.5 x 8.5 mm 0.335 x 0.335 in		QFP	Stations: CDB, CDEB, DIU, DDU, DMU Tools: T245, T245G, T245P, T245N
<b>C245224</b>	QFP Cartridge 12 x 12 mm 0.472 x 0.472 in		QFP	Stations: CDB, CDEB, DIU, DDU, DMU Tools: T245, T245G, T245P, T245N
<b>C245351</b>	QFP Cartridge 12.3 x 12.3 mm 0.484 x 0.484 in		QFP	Stations: CDB, CDEB, DIU, DDU, DMU Tools: T245, T245G, T245P, T245N
<b>C245228</b>	QFP Cartridge 12.4 x 15 mm 0.488 x 0.591 in		QFP	Stations: CDB, CDEB, DIU, DDU, DMU Tools: T245, T245G, T245P, T245N
<b>C245315</b>	QFP Cartridge 15 x 15 mm 0.591 x 0.591 in		QFP	Stations: CDB, CDEB, DIU, DDU, DMU Tools: T245, T245G, T245P, T245N
<b>C245352</b>	QFP Cartridge 15.4 x 15.4 mm 0.606 x 0.606 in		QFP	Stations: CDB, CDEB, DIU, DDU, DMU Tools: T245, T245G, T245P, T245N
<b>C245227</b>	QFP Cartridge 17.5 x 17.5 mm 0.689 x 0.689 in		QFP	Stations: CDB, CDEB, DIU, DDU, DMU Tools: T245, T245G, T245P, T245N





**C245 Cartridge Range for T245 General Purpose Handles**

Ref.	Description	Image and dimensions	Suggested components	Compatible with
<b>C245344</b>	QFP Cartridge 26 x 26 mm 1.024 x 1.024 in		QFP	Stations: CDB, CDEB, DIU, DDU, DMU Tools: T245, T245G, T245P, T245N
<b>C245248</b>	Socket Cartridge 11.9 x 14.4 mm 0.469 x 0.571 in		PLCC sockets	Stations: CDB, CDEB, DIU, DDU, DMU Tools: T245, T245G, T245P, T245N
<b>C245247</b>	Socket Cartridge 17 x 17 mm 0.669 x 0.669 in		PLCC sockets	Stations: CDB, CDEB, DIU, DDU, DMU Tools: T245, T245G, T245P, T245N
<b>C245053</b>	Heat Staking Cartridge Ø 3.8 mm Ø 0.149 in		Chrome finish, design for plastic rivets	Stations: CDB, CDEB, DIU, DDU, DMU Tools: T245, T245G, T245P, T245N
<b>C245052</b>	Heat Staking Cartridge Ø 4.9 mm Ø 0.193 in		Chrome finish, design for plastic rivets	Stations: CDB, CDEB, DIU, DDU, DMU Tools: T245, T245G, T245P, T245N
<b>C245054</b>	Heat Staking Cartridge Ø 6.5 mm Ø 0.256 in		Chrome finish, design for plastic rivets	Stations: CDB, CDEB, DIU, DDU, DMU Tools: T245, T245G, T245P, T245N
<b>C245798</b>	Heat Staking Cartridge Ø 8 mm Ø 0.315 in		Chrome finish, design for plastic rivets	Stations: CDB, CDEB, DIU, DDU, DMU Tools: T245, T245G, T245P, T245N
<b>C245791</b>	Heat Staking Cartridge Ø 9.8 mm Ø 0.386 in		Chrome finish, design for plastic rivets	Stations: CDB, CDEB, DIU, DDU, DMU Tools: T245, T245G, T245P, T245N

**C245 Cartridge Range for T245 General Purpose Handles**

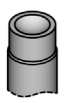
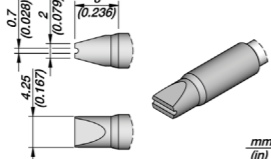
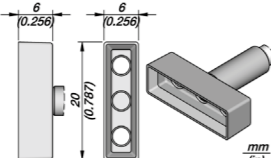
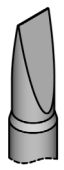
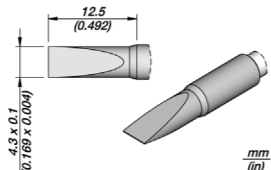
Ref.	Description	Image and dimensions	Suggested components	Compatible with
<b>C245143</b>	Double Heat Staking Cartridge Ø 1.8 mm Ø 0.071 in		Chrome finish, design for plastic rivets	Stations: CDB, CDEB, DIU, DDU, DMU Tools: T245, T245G, T245P, T245N
<b>C245163</b>	Hollow Heat Staking Cartridge Ø 2.5 mm Ø 0.098 in		Chrome finish, design for plastic rivets	Stations: CDB, CDEB, DIU, DDU, DMU Tools: T245, T245G, T245P, T245N
<b>C245166</b>	Plastics Inox. Cartridge Ø 1.7 mm Ø 0.067 in		Plastics	Stations: CDB, CDEB, DIU, DDU, DMU Tools: T245, T245G, T245P, T245N
<b>C245167</b>	Thermal Hole-Punch Cartridge for Plastic Ø 2.1 mm Ø 0.083 in		Plastics	Stations: CDB, CDEB, DIU, DDU, DMU Tools: T245, T245G, T245P, T245N
<b>C245168</b>	Thermal Hole-Punch Cartridge for Plastic Ø 3.1 mm Ø 0.122 in		Plastics	Stations: CDB, CDEB, DIU, DDU, DMU Tools: T245, T245G, T245P, T245N
<b>C245688</b>	Heat Staking Cartridge Ø 3.2 mm Ø 0.125 in		Plastics	Stations: CDB, CDEB, DIU, DDU, DMU Tools: T245, T245G, T245P, T245N
<b>C245312</b>	Cartridge for Plastics Ø 3.2 mm Ø 0.126 in		Plastics	Stations: CDB, CDEB, DIU, DDU, DMU Tools: T245, T245G, T245P, T245N
<b>C245313</b>	Cartridge for Plastics Ø 4.1 mm Ø 0.161 in		Plastics	Stations: CDB, CDEB, DIU, DDU, DMU Tools: T245, T245G, T245P, T245N
<b>C245123</b>	Cartridge for Plastics 4 x 4 mm 0.157 in		Plastics	Stations: CDB, CDEB, DIU, DDU, DMU Tools: T245, T245G, T245P, T245N

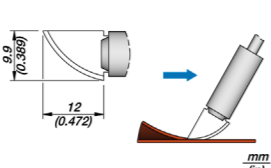
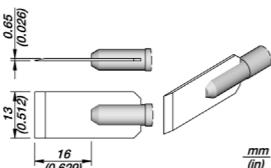
**C245 Cartridge Range for T245 General Purpose Handles**

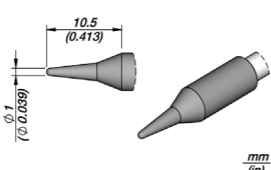
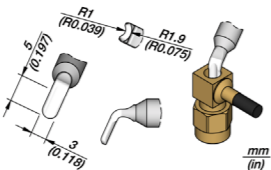
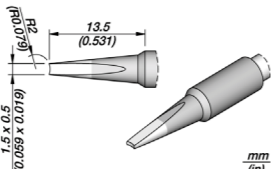
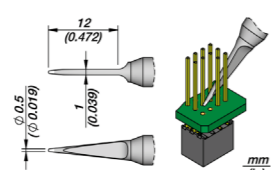
	Ref.	Description	Image and dimensions	Suggested components	Compatible with
	<b>C245124</b>	Cartridge for Plastics 4.25 x 2 mm 0.167 x 0.079 in		Plastics	Stations: CDB, CDEB, DIU, DDU, DMU Tools: T245, T245G, T245P, T245N
	<b>C245311</b>	Cartridge for Plastics 20 x 6 mm 0.787 x 0.256 in		Plastics	Stations: CDB, CDEB, DIU, DDU, DMU Tools: T245, T245G, T245P, T245N
	<b>C245109</b>	Conformal Coating Removal Cartridge 4.3 x 0.1 mm 0.169 x 0.004 in		Remove underfill encapsulants	Stations: CDB, CDEB, DIU, DDU, DMU Tools: T245, T245G, T245P, T245N
	<b>C245138</b>	Cutter Cartridge 12 mm 0.472 in		Plastic Rubber cutter	Stations: CDB, CDEB, DIU, DDU, DMU Tools: T245, T245G, T245P, T245N
	<b>C245121</b>	Cutter Cartridge 13 mm 0.512 in		Plastic Rubber cutter	Stations: CDB, CDEB, DIU, DDU, DMU Tools: T245, T245G, T245P, T245N
	<b>C245119</b>	Conical Teflon Cartridge Ø 1 mm Ø 0.039 in		Plastics	Stations: CDB, CDEB, DIU, DDU, DMU Tools: T245, T245G, T245P, T245N
	<b>C245116</b>	Pin/Connector Cartridge R. 1 mm R. 0.039 in		Through-hole Coaxial connector	Stations: CDB, CDEB, DIU, DDU, DMU Tools: T245, T245G, T245P, T245N
	<b>C245122</b>	Pin/Connect Cartridge 1.5 x 0.5 mm 0.059 x 0.019 in		Cylinder parts	Stations: CDB, CDEB, DIU, DDU, DMU Tools: T245, T245G, T245P, T245N
	<b>C245764</b>	Fine Pitch Cartridge Ø 0.5 mm Ø 0.019 in		Package 0603 QFP, IC Fine pitch	Stations: CDB, CDEB, DIU, DDU, DMU Tools: T245, T245G, T245P, T245N

**C245 Cartridge Range for T245 General Purpose Handles**

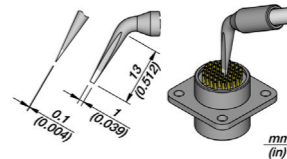
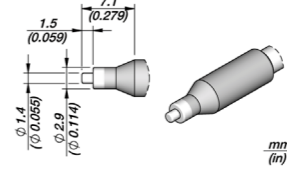
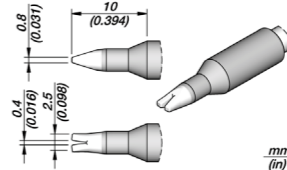
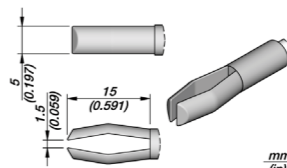
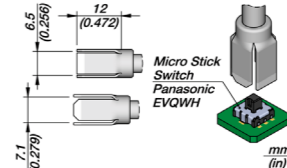
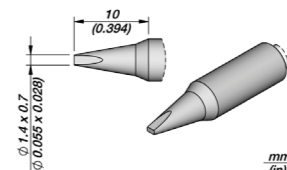
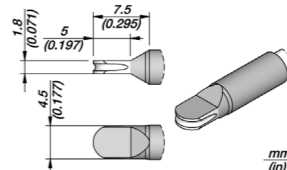
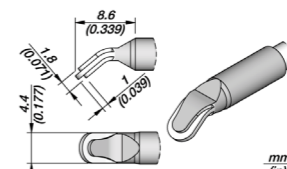
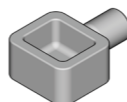
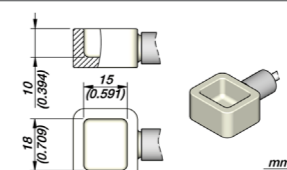
	Ref.	Description	Image and dimensions	Suggested components	Compatible with
	<b>C245771</b>	Bent Cartridge 1 x 0.1 mm 0.039 x 0.004 in		Cable soldering to connector Fine pitch	Stations: CDB, CDEB, DIU, DDU, DMU Tools: T245, T245G, T245P, T245N
	<b>C245117</b>	Flat Cartridge Ø 1.4 mm Ø 0.055 in		Through-hole	Stations: CDB, CDEB, DIU, DDU, DMU Tools: T245, T245G, T245P, T245N
	<b>C245118</b>	Pin/Wire Cartridge 0.4 mm 0.016 in		Through-hole Wire tinning	Stations: CDB, CDEB, DIU, DDU, DMU Tools: T245, T245G, T245P, T245N
	<b>C245268</b>	Pin/Wire Cartridge 1.5 mm 0.059 in		Through-hole	Stations: CDB, CDEB, DIU, DDU, DMU Tools: T245, T245G, T245P, T245N
	<b>C245136</b>	Micro Stick Switch Cartridge 7.1 x 6.5 mm 0.279 x 0.256 in		Micro Stick desoldering	Stations: CDB, CDEB, DIU, DDU, DMU Tools: T245, T245G, T245P, T245N
	<b>C245772</b>	Nickel Cartridge Ø 1.4 x 0.7 mm S1 Ø 0.055 x 0.028 in		HMP Soldering	Stations: CDB, CDEB, DIU, DDU, DMU Tools: T245, T245G, T245P, T245N
	<b>C245009</b>	S-Lead Cartridge 4.5 x 1.8 mm 0.177 x 0.071 in		Drag Soldering	Stations: CDB, CDEB, DIU, DDU, DMU Tools: T245, T245G, T245P, T245N
	<b>C245010</b>	J-Lead Cartridge 4.4 x 1.8 mm 0.177 x 0.071 in		Drag Soldering J-lead	Stations: CDB, CDEB, DIU, DDU, DMU Tools: T245, T245G, T245P, T245N
	<b>C245SP01</b>	Solder Pot Cartridge 15 x 18 mm 0.591 x 0.709 in		Tinning wires and Desoldering Through-hole Multipin components	Stations: CDB, CDEB, DIU, DDU, DMU Tools: T245, T245G, T245P, T245N

**C245E** Extended Tip Life Cartridge Range  
for T245 General Purpose Handles



Ref.	Description	Image and dimensions	Suggested components	Compatible with
<b>C245159E</b>	Chisel Cartridge 0.8 x 0.4 mm 0.031 x 0.016 in		General use	Stations: CDB, CDEB, DIU, DDU, DMU Tools: T245, T245G, T245P, T245N
<b>C245158E</b>	Chisel Cartridge 1.2 x 0.4 mm 0.047 x 0.016 in		General use	Stations: CDB, CDEB, DIU, DDU, DMU Tools: T245, T245G, T245P, T245N
<b>C245160E</b>	Chisel Cartridge 1.6 x 0.5 mm 0.063 x 0.020 in		General use	Stations: CDB, CDEB, DIU, DDU, DMU Tools: T245, T245G, T245P, T245N
<b>C245155E</b>	Chisel Cartridge 2.4 x 0.8 mm 0.094 x 0.031 in		General use	Stations: CDB, CDEB, DIU, DDU, DMU Tools: T245, T245G, T245P, T245N
<b>C245735E</b>	Chisel Cartridge 2.7 x 1 mm 0.106 x 0.039 in		General use	Stations: CDB, CDEB, DIU, DDU, DMU Tools: T245, T245G, T245P, T245N
<b>C245161E</b>	Chisel Cartridge 3.2 x 0.8 mm 0.126 x 0.031 in		General use	Stations: CDB, CDEB, DIU, DDU, DMU Tools: T245, T245G, T245P, T245N
<b>C245070E</b>	Chisel Cartridge 5 x 1.7 mm 0.197 x 0.067 in		General use	Stations: CDB, CDEB, DIU, DDU, DMU Tools: T245, T245G, T245P, T245N



**C245E** Extended Tip Life Cartridge Range for T245 General Purpose Handles

Ref.	Description	Image and dimensions	Suggested components	Compatible with
<b>C245968E</b>	Chisel Cartridge 6.6 x 1.8 mm 0.260 x 0.071 in		General use	Stations: CDB, CDEB, DIU, DDU, DMU Tools: T245, T245G, T245P, T245N
<b>C245156E</b>	Bevel Cartridge Ø 2.4 mm Ø 0.094 in		Drag soldering Through-hole	Stations: CDB, CDEB, DIU, DDU, DMU Tools: T245, T245G, T245P, T245N
<b>C245354E</b>	Bevel Cartridge Ø 3.5 mm L Ø 0.138 in		Drag soldering Through-hole	Stations: CDB, CDEB, DIU, DDU, DMU Tools: T245, T245G, T245P, T245N
<b>C245157E</b>	Knife Cartridge 7.2 mm 0.283 in		Drag soldering Through-hole	Stations: CDB, CDEB, DIU, DDU, DMU Tools: T245, T245G, T245P, T245N

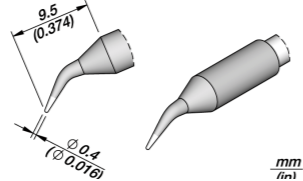
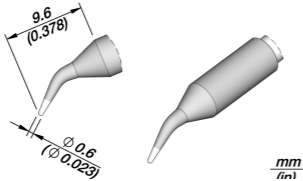
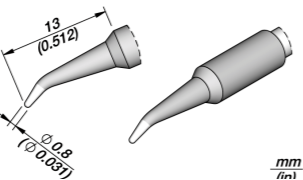
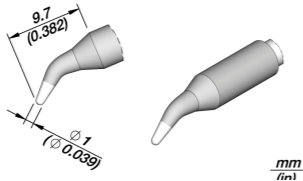
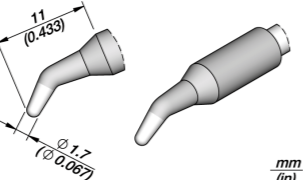
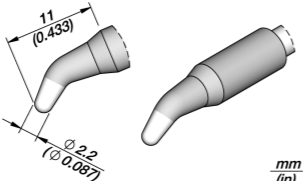

**C250 Cartridge Range**

for **AL250** Auto-Feed Iron and **AP250** Solder Feed Iron

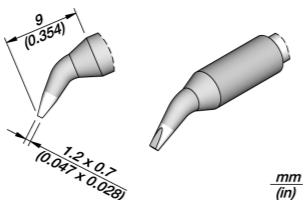

	Ref.	Description	Image and dimensions	Suggested components	Compatible with
	<b>C250420</b>	Conical Bent Cartridge Ø 0.4 mm Ø 0.016 in		Package 0201, 0402 Fine pitch 0.65 mm QFP, IC	Stations: AL, CDA Tools: AL250, AP250
	<b>C250401</b>	Conical Bent Cartridge Ø 0.6 mm Ø 0.023 in		Package 0603 QFP, IC	Stations: AL, CDA Tools: AL250, AP250
	<b>C250402</b>	Conical Bent Cartridge Ø 0.8 mm Ø 0.031 in		General use	Stations: AL, CDA Tools: AL250, AP250
	<b>C250403</b>	Conical Bent Cartridge Ø 1 mm Ø 0.039 in		General use	Stations: AL, CDA Tools: AL250, AP250
	<b>C250409</b>	Conical Bent Cartridge Ø 1.7 mm Ø 0.067 in		General use	Stations: AL, CDA Tools: AL250, AP250
	<b>C250410</b>	Conical Bent Cartridge Ø 2.2 mm Ø 0.087 in		General use	Stations: AL, CDA Tools: AL250, AP250
	<b>C250404</b>	Chisel Bent Cartridge 1.2 x 0.7 mm 0.047 x 0.028 in		General use	Stations: AL, CDA Tools: AL250, AP250

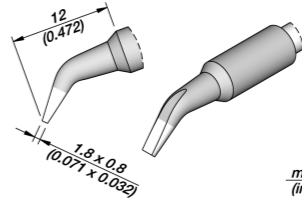
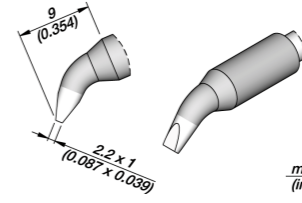
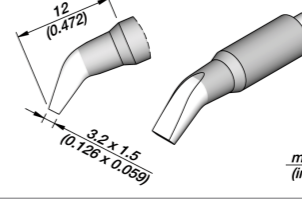
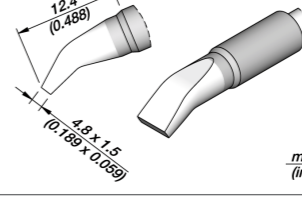
**C250 Cartridge Range for AL250 Auto-Feed Iron and AP250 Solder Feed Iron**

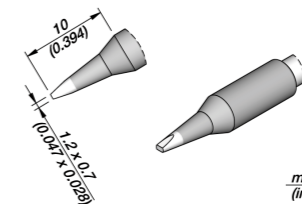
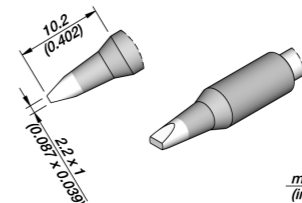
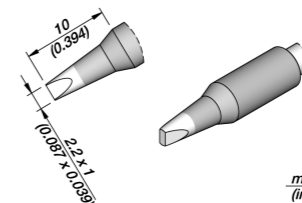
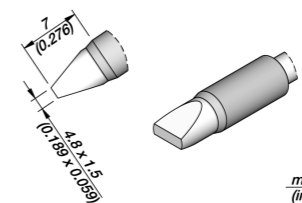
	Ref.	Description	Image and dimensions	Suggested components	Compatible with
	<b>C250405</b>	Chisel Bent Cartridge 1.8 x 0.8 mm 0.071 x 0.032 in		General use	Stations: AL, CDA Tools: AL250, AP250
	<b>C250406</b>	Chisel Bent Cartridge 2.2 x 1 mm 0.087 x 0.039 in		General use	Stations: AL, CDA Tools: AL250, AP250
	<b>C250418</b>	Chisel Bent Cartridge 3.2 x 1.5 mm 0.126 x 0.059 in		General use	Stations: AL, CDA Tools: AL250, AP250
	<b>C250412</b>	Chisel Bent Cartridge 4.8 x 1.5 mm 0.189 x 0.059 in		General use	Stations: AL, CDA Tools: AL250, AP250
	<b>C250407</b>	Chisel Cartridge 1.2 x 0.7 mm 0.047 x 0.028 in		General use	Stations: AL, CDA Tools: AL250, AP250
	<b>C250408</b>	Chisel Cartridge 2.2 x 1 mm S1 0.087 x 0.039 in		General use	Stations: AL, CDA Tools: AL250, AP250
	<b>C250413</b>	Chisel Cartridge 2.2 x 1 mm S2 0.087 x 0.039 in		General use	Stations: AL, CDA Tools: AL250, AP250
	<b>C250411</b>	Chisel Cartridge 4.8 x 1.5 mm 0.189 x 0.059 in		General use	Stations: AL, CDA Tools: AL250, AP250



**C250 Cartridge Range** for AL250 Auto-Feed Iron and AP250 Solder Feed Iron

Ref.	Description	Image and dimensions	Suggested components	Compatible with
<b>C250426</b>	Bevel Cartridge Ø 1.3 mm Ø 0.051 in		Drag soldering Through-hole	Stations: AL, CDA Tools: AL250, AP250
<b>C250414</b>	Bevel Cartridge Ø 2.2 mm Ø 0.087 in		Drag soldering Through-hole	Stations: AL, CDA Tools: AL250, AP250
<b>C250424</b>	Bevel Cartridge Ø 3 mm Ø 0.118 in		Drag soldering Through-hole	Stations: AL, CDA Tools: AL250, AP250
<b>C250415</b>	Bevel Cartridge Ø 3.8 mm Ø 0.149 in		Drag soldering Through-hole	Stations: AL, CDA Tools: AL250, AP250

**C420 Cartridge Range**  
for AT420 and HT420 Thermal Tweezers





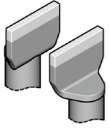
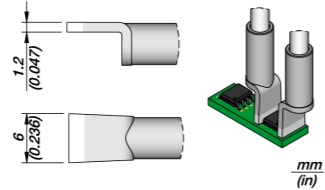
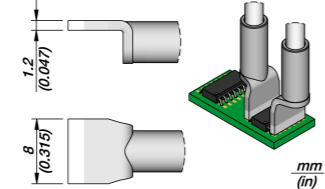
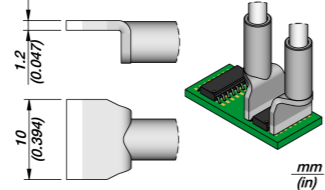
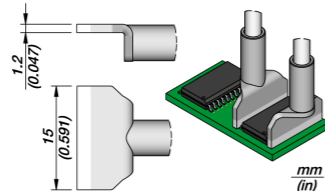
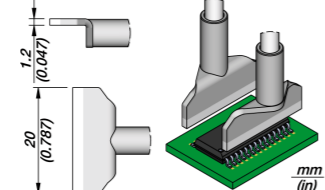
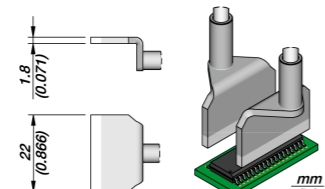
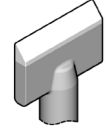
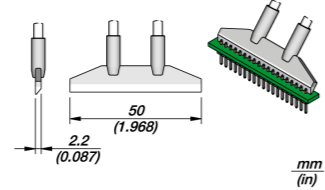
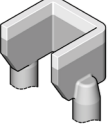
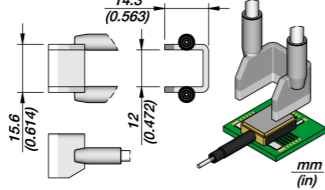

Ref.	Description	Image and dimensions	Suggested components	Compatible with
<b>C420271</b>	Chip Cartridge 1.5 mm 0.059 in		SMD resistors SMD capacitors	Stations: DIU, DDU, DMU Tools: AT420, HT420
<b>C420287</b>	Chip Cartridge 2 mm 0.079 in		Customized	Stations: DIU, DDU, DMU Tools: AT420, HT420
<b>C420272</b>	Chip Cartridge 2.6 mm 0.102 in		SMD resistors SMD capacitors	Stations: DIU, DDU, DMU Tools: AT420, HT420
<b>C420279</b>	QFP Cartridge 8 mm 0.315 in		QFP PLCC	Stations: DIU, DDU, DMU Tools: AT420, HT420
<b>C420280</b>	QFP Cartridge 11 mm 0.433 in		QFP PLCC	Stations: DIU, DDU, DMU Tools: AT420, HT420
<b>C420288</b>	QFP Cartridge 14.5 mm 0.571 in		QFP PLCC	Stations: DIU, DDU, DMU Tools: AT420, HT420
<b>C420273</b>	Blade Cartridge 4 mm 0.157 in		Package 1210, 1812 SO, SOT DIP	Stations: DIU, DDU, DMU Tools: AT420, HT420

**C420 Cartridge Range for AT420 and HT420 Thermal Tweezers**

	Ref.	Description	Image and dimensions	Suggested components	Compatible with
	<b>C420274</b>	Blade Cartridge 6 mm 0.236 in		DIP IC	Stations: DIU, DDU, DMU Tools: AT420, HT420
	<b>C420275</b>	Blade Cartridge 8 mm 0.315 in		DIP IC	Stations: DIU, DDU, DMU Tools: AT420, HT420
	<b>C420276</b>	Blade Cartridge 10 mm 0.394 in		DIP IC	Stations: DIU, DDU, DMU Tools: AT420, HT420
	<b>C420277</b>	Blade Cartridge 15 mm 0.591 in		DIP IC	Stations: DIU, DDU, DMU Tools: AT420, HT420
	<b>C420278</b>	Blade Cartridge 20 mm 0.787 in		DIP IC	Stations: DIU, DDU, DMU Tools: AT420, HT420
	<b>C420285</b>	Blade Cartridge 22 mm 0.866 in		DIP IC	Stations: DIU, DDU, DMU Tools: AT420, HT420
	<b>C420283</b>	Blade Cartridge 50 mm 1.968 in		Pad cleaning Connector desoldering	Stations: DIU, DDU, DMU Tools: AT420, HT420
	<b>C420286</b>	"U" Shape Cartridge 15.6 x 14.3 mm 0.614 x 0.563 in		Customized	Stations: DIU, DDU, DMU Tools: AT420, HT420

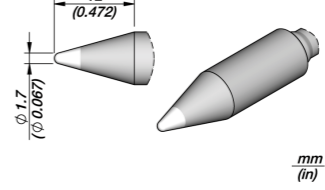
**C470 Cartridge Range**  
for **T470** HD Handles and **HT470** HD Thermal Tweezers

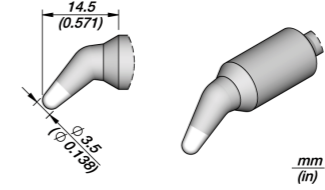

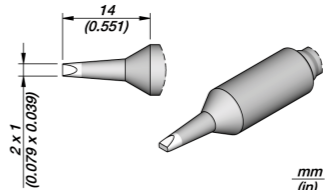
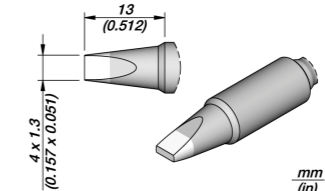
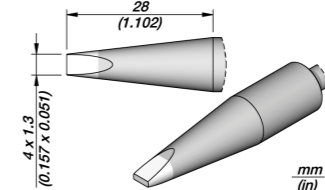



	Ref.	Description	Image and dimensions	Suggested components	Compatible with
	<b>C470001</b>	Conical Cartridge Ø 1.7 mm Ø 0.067 in		General use	Station: HDU Tools: T470, T470S, T470F, T470M, T470Z, T470N
	<b>C470008</b>	Conical Bent Cartridge Ø 3.5 mm Ø 0.138 in		General use	Station: HDU Tools: T470, T470S, T470F, T470M, T470Z, T470N
	<b>C470013</b>	Chisel Cartridge 2 x 0.9 mm 0.079 x 0.035 in		General use	Station: HDU Tools: T470, T470S, T470F, T470M, T470Z, T470N
	<b>C470036</b>	Chisel Cartridge 2 x 1 mm 0.079 x 0.039 in		General use	Station: HDU Tools: T470, T470S, T470F, T470M, T470Z, T470N
	<b>C470014</b>	Chisel Cartridge 4 x 1.3 mm S1 0.157 x 0.051 in		General use	Station: HDU Tools: T470, T470S, T470F, T470M, T470Z, T470N
	<b>C470040</b>	Chisel Cartridge 4 x 1.3 mm S2 0.157 x 0.051 in		General use	Station: HDU Tools: T470, T470S, T470F, T470M, T470Z, T470N
	<b>C470035</b>	Chisel Cartridge 4 x 2.5 mm 0.157 x 0.098 in		General use	Station: HDU Tools: T470, T470S, T470F, T470M, T470Z, T470N

**C470 Cartridge Range for T470 HD Handles and HT470 HD Thermal Tweezers**

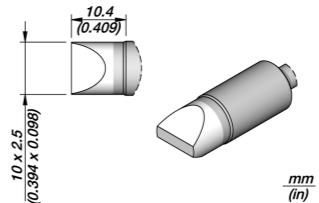
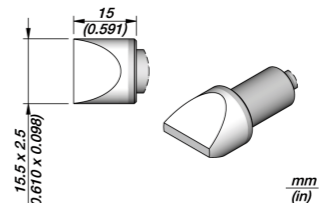
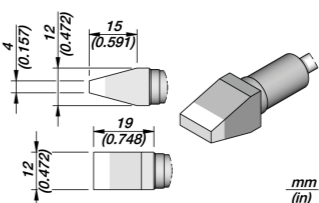
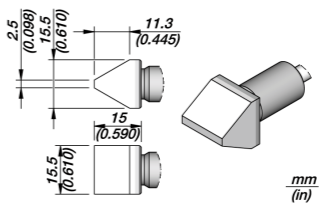
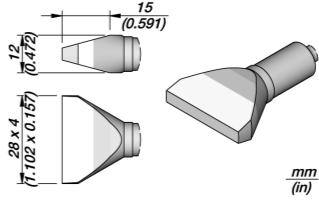
	Ref.	Description	Image and dimensions	Suggested components	Compatible with
	<b>C470017</b>	Chisel Cartridge 5 x 1.2 mm 0.197 x 0.047 in		General use	Station: HDU Tools: T470, T470S, T470F, T470M, T470Z, T470N
	<b>C470009</b>	Chisel Cartridge 5.5 x 1.5 mm 0.216 x 0.059 in		General use Sheet metal	Station: HDU Tools: T470, T470S, T470F, T470M, T470Z, T470N
	<b>C470002</b>	Chisel Cartridge 6 x 1.5 mm 0.236 x 0.059 in		General use Sheet metal	Station: HDU Tools: T470, T470S, T470F, T470M, T470Z, T470N
	<b>C470015</b>	Chisel Cartridge 6 x 1.7 mm 0.236 x 0.067 in		General use	Station: HDU Tools: T470, T470S, T470F, T470M, T470Z, T470N
	<b>C470004</b>	Chisel Cartridge 7.5 x 1.5 mm 0.295 x 0.059 in		General use Sheet metal	Station: HDU Tools: T470, T470S, T470F, T470M, T470Z, T470N
	<b>C470016</b>	Chisel Cartridge 7.5 x 1.7 mm 0.295 x 0.067 in		General use	Station: HDU Tools: T470, T470S, T470F, T470M, T470Z, T470N
	<b>C470058</b>	Chisel Cartridge 8 x 2.5 mm 0.315 x 0.098 in		General use Sheet metal	Station: HDU Tools: T470, T470S, T470F, T470M, T470Z, T470N
	<b>C470039</b>	Chisel Cartridge 8.5 x 2.5 mm 0.335 x 0.098 in		General use Sheet metal	Station: HDU Tools: T470, T470S, T470F, T470M, T470Z, T470N

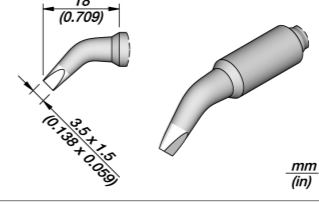
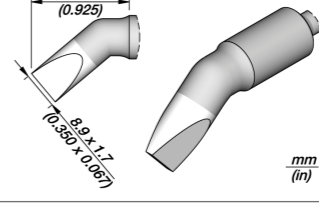
**C470 Cartridge Range for T470 HD Handles and HT470 HD Thermal Tweezers**

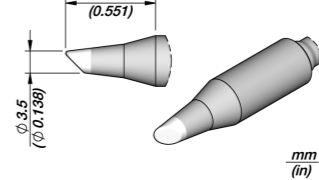
	Ref.	Description	Image and dimensions	Suggested components	Compatible with
	<b>C470006</b>	Chisel Cartridge 10 x 2.5 mm 0.394 x 0.098 in		General use Sheet metal	Station: HDU Tools: T470, T470S, T470F, T470M, T470Z, T470N
	<b>C470007</b>	Chisel Cartridge 15.5 x 2.5 mm 0.610 x 0.098 in		General use Sheet metal	Station: HDU Tools: T470, T470S, T470F, T470M, T470Z, T470N
	<b>C470021</b>	Chisel Cartridge 12 x 4 mm 0.472 x 0.157 in		General use Sheet metal	Station: HDU Tools: T470, T470S, T470F, T470M, T470Z, T470N
	<b>C470067</b>	Chisel Cartridge 15.5 X 2.5 mm 0.610 x 0.098 in		General use Sheet metal	Station: HDU Tools: T470, T470S, T470F, T470M, T470Z, T470N, HT470
	<b>C470022</b>	Chisel Cartridge 28 x 4 mm 1.102 x 0.157 in		Sheet metal	Station: HDU Tools: T470, T470S, T470F, T470M, T470Z, T470N
	<b>C470034</b>	Chisel Bent Cartridge 3.5 x 1.5 mm 0.138 x 0.059 in		General use	Station: HDU Tools: T470, T470S, T470F, T470M, T470Z, T470N
	<b>C470018</b>	Chisel Bent Cartridge 8.9 x 1.7 mm 0.350 x 0.067 in		General use Sheet metal	Station: HDU Tools: T470, T470S, T470F, T470M, T470Z, T470N
	<b>C470019</b>	Bevel Cartridge Ø 3.5 mm Ø 0.138 in		General use	Station: HDU Tools: T470, T470S, T470F, T470M, T470Z, T470N

**C470** Cartridges for **T470** HD Handles and **HT470** HD Thermal Tweezers

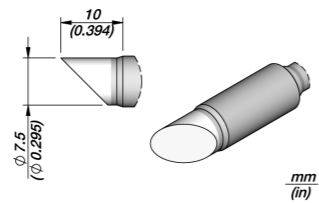
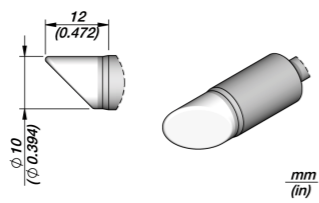
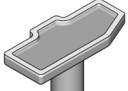
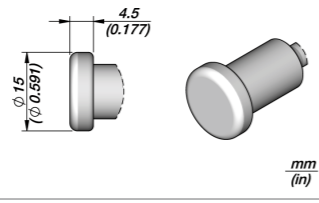
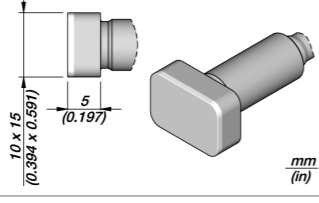
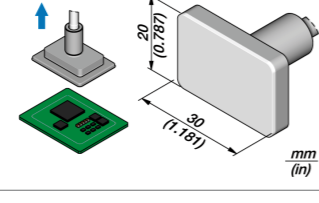
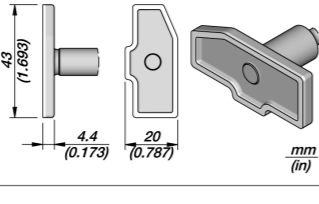
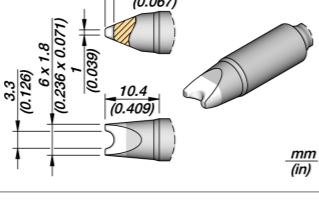
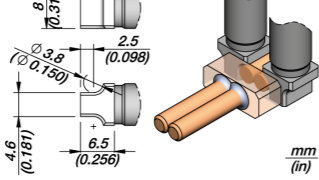
	Ref.	Description	Image and dimensions	Suggested components	Compatible with
	<b>C470003</b>	Bevel Cartridge Ø 7.5 mm Ø 0.295 in		General use Sheet metal	Station: HDU Tools: T470, T470S, T470F, T470M, T470Z, T470N
	<b>C470056</b>	Bevel Cartridge Ø 10 mm Ø 0.394 in		Wide area Shield desoldering Sheet metal	Station: HDU Tools: T470, T470S, T470F, T470M, T470Z, T470N
	<b>C470005</b>	Flat Cartridge Ø 15 mm Ø 0.591 in		Shield desoldering Metal PCB Sheet metal	Station: HDU Tools: T470, T470S, T470F, T470M, T470Z, T470N
	<b>C470044</b>	Flat Cartridge 10 x 15 mm 0.394 x 0.591 in		Shield desoldering Metal PCB Sheet metal	Station: HDU Tools: T470, T470S, T470F, T470M, T470Z, T470N
	<b>C470057</b>	Flat Cartridge 20 x 30 mm 0.787 x 1.181 in		Shield desoldering Metal PCB Sheet metal	Station: HDU Tools: T470, T470S, T470F, T470M, T470Z, T470N
	<b>C470027</b>	Shield Cartridge 43 x 20 mm 1.693 x 0.787 in		Shield desoldering	Station: HDU Tools: T470, T470S, T470F, T470M, T470Z, T470N
	<b>C470031</b>	Pin/Connector Cartridge Ø 3.3 mm Ø 0.126 in		Cable Through-hole	Station: HDU Tools: T470, T470S, T470F, T470M, T470Z, T470N
	<b>C470050</b>	Pin/Connector Cartridge Ø 3.8 mm Ø 0.150 in		Cable Connectors	Station: HDU Tools: T470, T470S, T470F, T470M, T470N, HT470

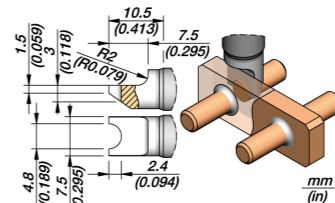
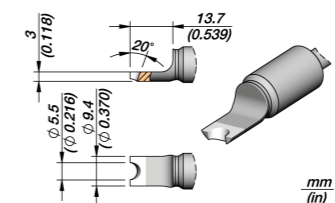
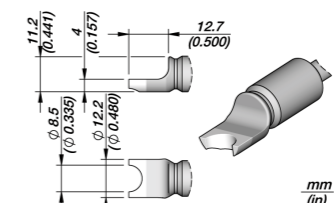
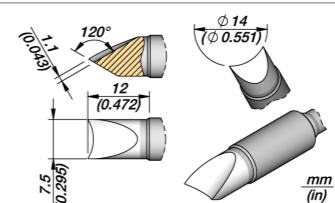
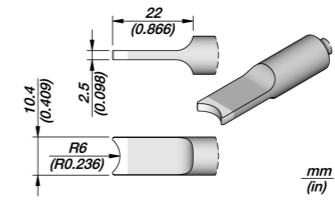
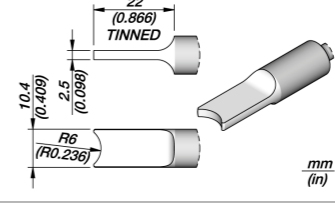
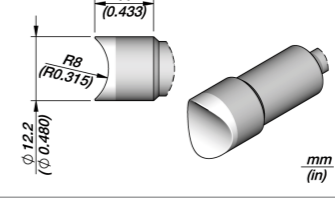
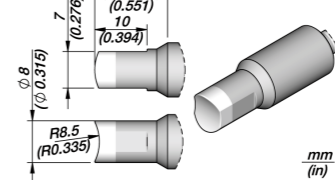

**C470** Cartridges for **T470** HD Handles and **HT470** HD Thermal Tweezers

	Ref.	Description	Image and dimensions	Suggested components	Compatible with
	<b>C470042</b>	Pin/Connector Cartridge Ø 4.8 mm Ø 0.189 in		Cable Through-hole	Station: HDU Tools: T470, T470S, T470F, T470M, T470Z, T470N, HT470
	<b>C470066</b>	Pin/Connector Cartridge Ø 5.5 mm Ø 0.216 in		Cable Through-hole	Station: HDU Tools: T470, T470S, T470F, T470M, T470Z, T470N
	<b>C470065</b>	Pin/Connector Cartridge Ø 8.5 mm Ø 0.335 in		Cable Through-hole	Station: HDU Tools: T470, T470S, T470F, T470M, T470Z, T470N
	<b>C470047</b>	Pin/Connector Cartridge Ø 14 mm Ø 0.551 in		Cable Through-hole	Station: HDU Tools: T470, T470S, T470F, T470M, T470Z, T470N
	<b>C470012</b>	Pin/Connector Cartridge R. 6 mm S1 R. 0.236 in		Cables Connectors	Station: HDU Tools: T470, T470S, T470F, T470M, T470Z, T470N
	<b>C470038</b>	Pin/Connector Cartridge R. 6 mm S2 R. 0.236 in		Wide area Cables Connectors	Station: HDU Tools: T470, T470S, T470F, T470M, T470Z, T470N
	<b>C470010</b>	Pin/Connector Cartridge R. 8 mm R. 0.315 in		Cables connectors	Station: HDU Tools: T470, T470S, T470F, T470M, T470Z, T470N
	<b>C470052</b>	Pin/Connector Cartridge R. 8.5 mm R. 0.335 in		Cables connectors	Station: HDU Tools: T470, T470S, T470F, T470M, T470Z, T470N





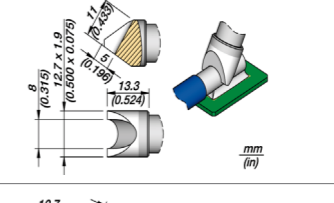
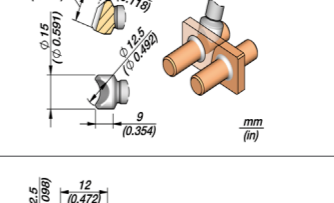
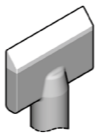
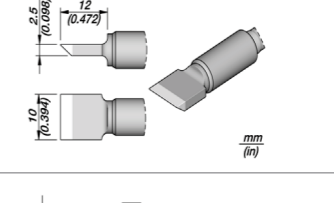
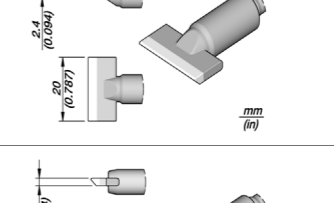
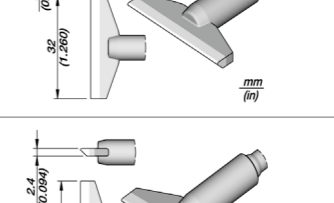
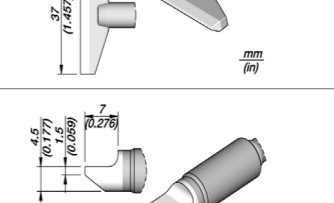
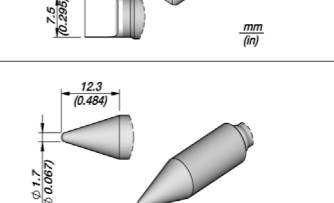

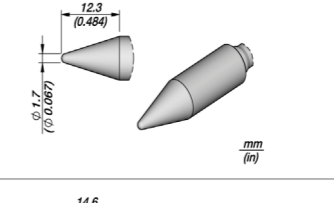
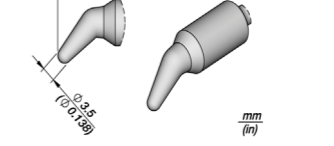
**C470 Cartridge Range for T470 HD Handles and HT470 HD Thermal Tweezers**

	Ref.	Description	Image and dimensions	Suggested components	Compatible with
	<b>C470029</b>	Pin/Connector Cartridge R. 31 mm R. 1.220 in		Connectors	Station: HDU Tools: T470, T470S, T470F, T470M, T470Z, T470N
	<b>C470028</b>	Pin/Connector Cartridge Ø 1.2 mm Ø 0.047 in		Cable Through-hole	Station: HDU Tools: T470, T470S, T470F, T470M, T470Z, T470N
	<b>C470020</b>	Pin Cartridge Ø 2.4 mm Ø 0.094 in		Through-hole	Station: HDU Tools: T470, T470S, T470F, T470M, T470Z, T470N
	<b>C470048</b>	Pin/Connector Cartridge Ø 3.4 mm Ø 0.134 in		Cable Through-hole	Station: HDU Tools: T470, T470S, T470F, T470M, T470Z, T470N
	<b>C470033</b>	Pin/Connector Cartridge Ø 3.65 mm Ø 0.144 in		Cable Through-hole	Station: HDU Tools: T470, T470S, T470F, T470M, T470Z, T470N
	<b>C470055</b>	Pin/Connector Cartridge Ø 4 mm Ø 0.157 in		Cable Through-hole	Station: HDU Tools: T470, T470S, T470F, T470M, T470Z, T470N
	<b>C470049</b>	Pin/Connector Cartridge Ø 5.2 mm Ø 0.205 in		Cable Through-hole	Station: HDU Tools: T470, T470S, T470F, T470M, T470Z, T470N
	<b>C470030</b>	Pin/Connector Cartridge Ø 5 mm Ø 0.197 in		Cable Through-hole	Station: HDU Tools: T470, T470S, T470F, T470M, T470Z, T470N

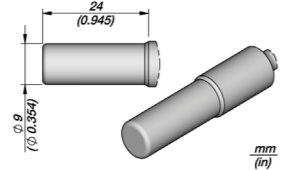
**C470 Cartridge Range for T470 HD Handles and HT470 HD Thermal Tweezers**

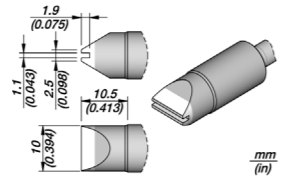
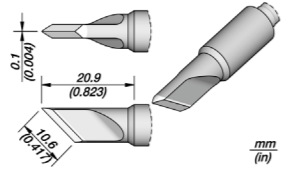

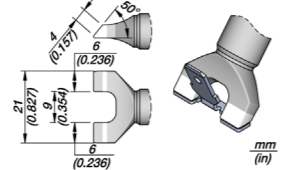
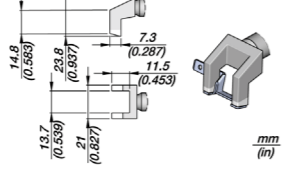

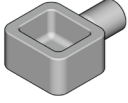
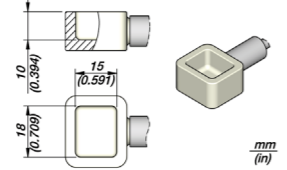
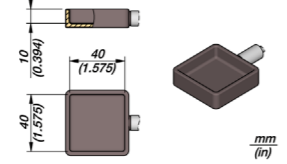



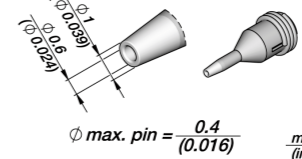

	Ref.	Description	Image and dimensions	Suggested components	Compatible with
	<b>C470037</b>	Pin/Connector Cartridge Ø 8 mm Ø 0.315 in		Cable Through-hole	Station: HDU Tools: T470, T470S, T470F, T470M, T470Z, T470N
	<b>C470041</b>	Pin/Connector Cartridge Ø 12.5 mm Ø 0.492 in		Cable Through-hole	Station: HDU Tools: T470, T470S, T470F, T470M, T470Z, T470N
	<b>C470064</b>	Blade Cartridge 10 mm 0.394 in		Pad cleaning Connector desoldering	Station: HDU Tools: T470, T470S, T470F, T470M, T470Z, T470N, HT470
	<b>C470059</b>	Blade Cartridge 20 mm 0.787 in		Pad cleaning Connector desoldering	Station: HDU Tools: T470, T470S, T470F, T470M, T470Z, T470N, HT470
	<b>C470023</b>	Blade Cartridge 32 mm 1.260 in		Pad cleaning Connector desoldering	Station: HDU Tools: T470, T470S, T470F, T470M, T470Z, T470N, HT470
	<b>C470063</b>	Blade Cartridge 37 mm 1.457 in		Pad cleaning Connector desoldering	Station: HDU Tools: T470, T470S, T470F, T470M, T470Z, T470N, HT470
	<b>C470046</b>	Single Flat Cartridge 7.5 mm 0.295 in		General use Sheet metal	Station: HDU Tools: T470, T470S, T470F, T470M, T470Z, T470N, HT470
	<b>C470025</b>	Cartridge for Plastics Ø 1.7 mm Ø 0.067 in		Plastics	Station: HDU Tools: T470, T470S, T470F, T470M, T470Z, T470N
	<b>C470026</b>	Cartridge for Plastics Ø 3.5 mm Ø 0.138 in		Plastics	Station: HDU Tools: T470, T470S, T470F, T470M, T470Z, T470N

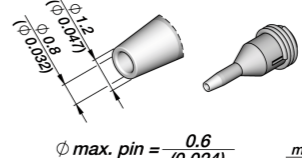
**C470 Cartridge Range for T470 HD Handles and HT470 HD Thermal Tweezers**

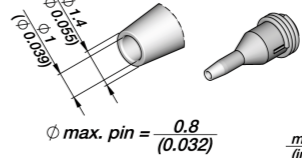
	Ref.	Description	Image and dimensions	Suggested components	Compatible with
	<b>C470032</b>	Cartridge for Plastics Ø 9 mm Ø 0.354 in		Plastics	Station: HDU Tools: T470, T470S, T470F, T470M, T470Z, T470N
	<b>C470043</b>	Groove Cartridge 1.1 x 10 mm 0.043 x 0.394 in		Wire soldering	Station: HDU Tools: T470, T470S, T470F, T470M, T470Z, T470N
	<b>C470061</b>	Knife Cartridge 10.6 mm 0.417 in		Drag Soldering	Station: HDU Tools: T470, T470S, T470F, T470M, T470Z, T470N
	<b>C470051</b>	Blade Split Cartridge 21 mm 0.827 in		Connectors	Station: HDU Tools: T470, T470S, T470F, T470M, T470Z, T470N
	<b>C470070</b>	Faston Terminal Cartridge 21 mm 0.827 in		Connectors	Station: HDU Tools: T470, T470S, T470F, T470M, T470Z, T470N
	<b>C470045</b>	Pin Cartridge Ø 3.5 mm Ø 0.138 in		Through-hole Male connector	Station: HDU Tools: T470, T470S, T470F, T470M, T470Z, T470N
	<b>C470011</b>	Hook Cartridge Ø 4.2 mm Ø 0.165 in		Difficult to reach	Station: HDU Tools: T470, T470S, T470F, T470M, T470Z, T470N
	<b>C470SP01</b>	Solder Pot Cartridge 15 x 18 mm 0.591 x 0.709 in		Tinnig wires Desoldering Through-hole Multipin components	Station: HDU Tools: T470, T470S, T470F, T470M, T470Z, T470N
	<b>C470SP42</b>	Solder Pot Cartridge 40 x 40 mm 1.575 x 1.575 in		Tinnig wires Desoldering Through-hole Multipin components	Station: HDU Tools: T470, T470S, T470F, T470M, T470Z, T470N

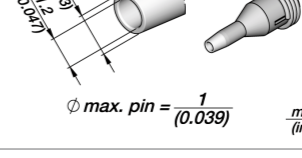
**C360 Tip Range for DS360 Micro Desoldering Iron**

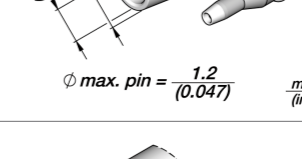

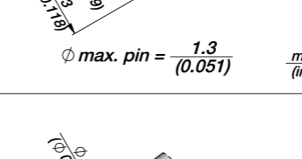
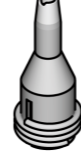
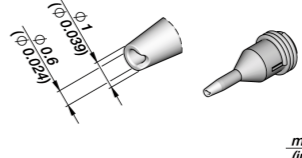
	Ref.	Description	Image and dimensions	Suggested components	Compatible with
	<b>C360001</b>	Micro Desoldering Tip Ø 0.6 mm Ø 0.024 in		Through-hole Desoldering	Stations: CDD, DIU, DDU, DMU Tool: DS360 Modules: MSE, MS
	<b>C360002</b>	Micro Desoldering Tip Ø 0.8 mm Ø 0.032 in		Through-hole Desoldering	Stations: CDD, DIU, DDU, DMU Tool: DS360 Modules: MSE, MS
	<b>C360003</b>	Micro Desoldering Tip Ø 1 mm Ø 0.039 in		Through-hole Desoldering	Stations: CDD, DIU, DDU, DMU Tool: DS360 Modules: MSE, MS
	<b>C360004</b>	Micro Desoldering Tip Ø 1.2 mm Ø 0.047 in		Through-hole Desoldering	Stations: CDD, DIU, DDU, DMU Tool: DS360 Modules: MSE, MS
	<b>C360007</b>	Micro Desoldering Tip Ø 1.4 mm Ø 0.055 in		Through-hole Desoldering	Stations: CDD, DIU, DDU, DMU Tool: DS360 Modules: MSE, MS
	<b>C360006</b>	Micro Desoldering Tip Ø 1.5 mm Ø 0.059 in		Through-hole Desoldering	Stations: CDD, DIU, DDU, DMU Tool: DS360 Modules: MSE, MS
	<b>C360011</b>	Micro Desoldering Tip Ø 0.6 mm Pad Ø 0.024 in		Pad desoldering	Stations: CDD, DIU, DDU, DMU Tool: DS360 Modules: MSE, MS

**C360 Tip Range** for DS360 Micro Desoldering Iron



Ref.	Description	Image and dimensions	Suggested components	Compatible with
<b>C360012</b>	Micro Desoldering Tip Ø 0.8 mm Pad Ø 0.032 in		Pad desoldering	Stations: CDD, DIU, DDU, DMU Tool: DS360 Modules: MSE, MS
<b>C360013</b>	Micro Desoldering Tip Ø 1 mm Pad Ø 0.039 in		Pad desoldering	Stations: CDD, DIU, DDU, DMU Tool: DS360 Modules: MSE, MS
<b>C360014</b>	Micro Desoldering Tip Ø 1.2 mm Pad Ø 0.047 in		Pad desoldering	Stations: CDD, DIU, DDU, DMU Tool: DS360 Modules: MSE, MS

**C560 Tip Range**  
for DR560 Desoldering Iron

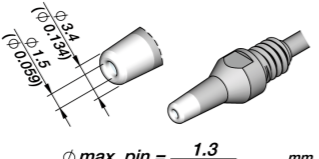
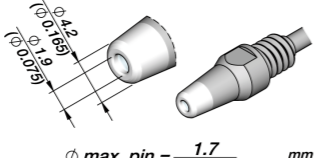
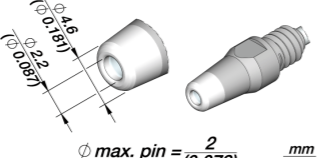
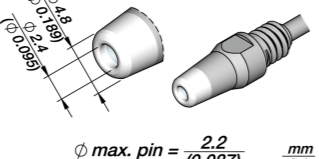
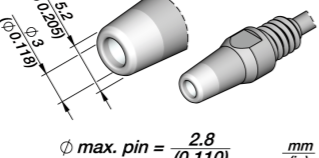

Ref.	Description	Image and dimensions	Suggested components	Compatible with
<b>C560001</b>	Desoldering Tip Ø 0.6 mm HT Ø 0.024 in		Through-hole Desoldering	Stations: DIU, DDU, DMU Tool: DR560 Modules: MSE, MS
<b>C560014</b>	Desoldering Tip Ø 0.8 mm Ø 0.032 in		Through-hole Desoldering	Stations: DIU, DDU, DMU Tool: DR560 Modules: MSE, MS
<b>C560002</b>	Desoldering Tip Ø 0.8 mm HT Ø 0.032 in		Through-hole Desoldering	Stations: DIU, DDU, DMU Tool: DR560 Modules: MSE, MS
<b>C560003</b>	Desoldering Tip Ø 1 mm Ø 0.039 in		Through-hole Desoldering	Stations: DIU, DDU, DMU Tool: DR560 Modules: MSE, MS
<b>C560017</b>	Desoldering Tip Ø 1.1 mm Ø 0.043 in		Through-hole Desoldering	Stations: DIU, DDU, DMU Tool: DR560 Modules: MSE, MS
<b>C560004</b>	Desoldering Tip Ø 1.3 x Ø 3.2 mm Ø 0.052 x Ø 0.126 in		Through-hole Desoldering	Stations: DIU, DDU, DMU Tool: DR560 Modules: MSE, MS
<b>C560009</b>	Desoldering Tip Ø 1.3 x Ø 5 mm Ø 0.052 x Ø 0.197 in		Through-hole Desoldering	Stations: DIU, DDU, DMU Tool: DR560 Modules: MSE, MS

C560 Tip Range for DR560 Desoldering Iron

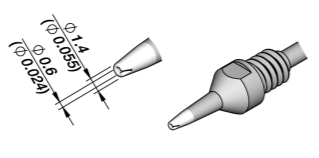
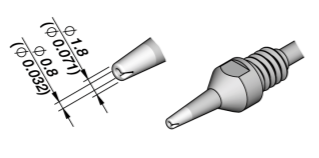
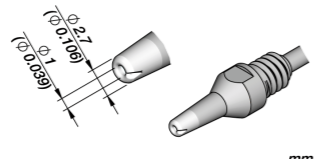
	Ref.	Description	Image and dimensions	Suggested components	Compatible with
	C560005	Desoldering Tip Ø 1.5 mm Ø 0.059 in	 $\phi \text{ max. pin} = \frac{1.3}{(0.051)} \frac{\text{mm}}{\text{(in)}}$	Through-hole Desoldering	Stations: DIU, DDU, DMU Tool: DR560 Modules: MSE, MS
	C560006	Desoldering Tip Ø 1.9 mm Ø 0.075 in	 $\phi \text{ max. pin} = \frac{1.7}{(0.067)} \frac{\text{mm}}{\text{(in)}}$	Through-hole Desoldering	Stations: DIU, DDU, DMU Tool: DR560 Modules: MSE, MS
	C560018	Desoldering Tip Ø 2.2 mm Ø 0.087 in	 $\phi \text{ max. pin} = \frac{2}{(0.079)} \frac{\text{mm}}{\text{(in)}}$	Through-hole Desoldering	Stations: DIU, DDU, DMU Tool: DR560 Modules: MSE, MS
	C560007	Desoldering Tip Ø 2.4 mm Ø 0.095 in	 $\phi \text{ max. pin} = \frac{2.2}{(0.087)} \frac{\text{mm}}{\text{(in)}}$	Through-hole Desoldering	Stations: DIU, DDU, DMU Tool: DR560 Modules: MSE, MS
	C560015	Desoldering Tip Ø 3 mm Ø 0.118 in	 $\phi \text{ max. pin} = \frac{2.8}{(0.110)} \frac{\text{mm}}{\text{(in)}}$	Through-hole Desoldering	Stations: DIU, DDU, DMU Tool: DR560 Modules: MSE, MS
		C560011	Desoldering Tip Ø 0.6 mm HT Pad Ø 0.024 in	 $\frac{\text{mm}}{\text{(in)}}$	Pad desoldering
C560012		Desoldering Tip Ø 0.8 mm HT Pad Ø 0.032 in	 $\frac{\text{mm}}{\text{(in)}}$	Pad desoldering	Stations: DIU, DDU, DMU Tool: DR560 Modules: MSE, MS
C560013		Desoldering Tip Ø 1 mm Pad Ø 0.039 in	 $\frac{\text{mm}}{\text{(in)}}$	Pad desoldering	Stations: DIU, DDU, DMU Tool: DR560 Modules: MSE, MS

W140 Blade Cartridge Range  
for WS140 High-Temperature Precision  
Wire Stripper Tweezers

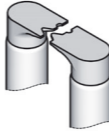
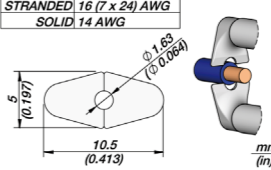
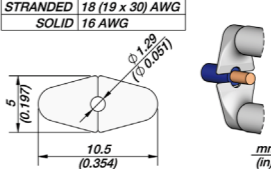
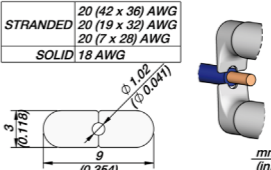
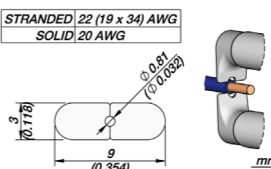
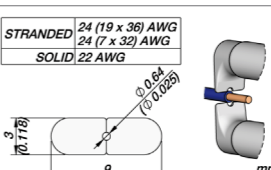
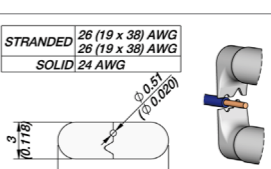
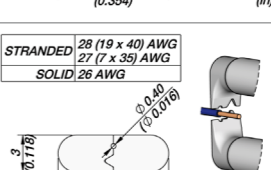
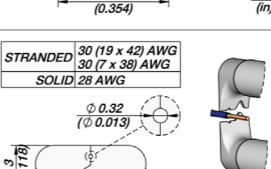

	Ref.	Description	Image and dimensions	Suggested components	Compatible with
	W14014G	Single-Hole Cartridges Solid Wire 14 AWG	 STRANDED 16 (7 x 24) AWG SOLID 14 AWG $\phi 1.63$ $(\phi 0.064)$ 5 $(0.197)$ 10.5 $(0.413)$ $\frac{\text{mm}}{\text{(in)}}$	Wire insulation stripping	Station: WSS Tool: WS140
	W14016G	Single-Hole Cartridges Solid Wire 16 AWG	 STRANDED 18 (19 x 30) AWG SOLID 16 AWG $\phi 1.28$ $(\phi 0.051)$ 5 $(0.197)$ 10.5 $(0.354)$ $\frac{\text{mm}}{\text{(in)}}$	Wire insulation stripping	Station: WSS Tool: WS140
	W14018G	Single-Hole Cartridges Solid Wire 18 AWG	 STRANDED 20 (42 x 36) AWG 20 (19 x 32) AWG 20 (7 x 28) AWG SOLID 18 AWG $\phi 1.02$ $(\phi 0.041)$ 3 $(0.118)$ 9 $(0.354)$ $\frac{\text{mm}}{\text{(in)}}$	Wire insulation stripping	Station: WSS Tool: WS140
	W14020G	Single-Hole Cartridges Solid Wire 20 AWG	 STRANDED 22 (19 x 34) AWG SOLID 20 AWG $\phi 0.81$ $(\phi 0.032)$ 3 $(0.118)$ 9 $(0.354)$ $\frac{\text{mm}}{\text{(in)}}$	Wire insulation stripping	Station: WSS Tool: WS140
	W14022G	Single-Hole Cartridges Solid Wire 22 AWG	 STRANDED 24 (19 x 38) AWG 24 (7 x 32) AWG SOLID 22 AWG $\phi 0.64$ $(\phi 0.025)$ 3 $(0.118)$ 9 $(0.354)$ $\frac{\text{mm}}{\text{(in)}}$	Wire insulation stripping	Station: WSS Tool: WS140
	W14024G	Single-Hole Cartridges Solid Wire 24 AWG	 STRANDED 26 (19 x 38) AWG 26 (19 x 38) AWG SOLID 24 AWG $\phi 0.51$ $(\phi 0.020)$ 3 $(0.118)$ 9 $(0.354)$ $\frac{\text{mm}}{\text{(in)}}$	Wire insulation stripping	Station: WSS Tool: WS140
	W14026G	Single-Hole Cartridges Solid Wire 26 AWG	 STRANDED 28 (19 x 40) AWG 27 (7 x 35) AWG SOLID 26 AWG $\phi 0.40$ $(\phi 0.016)$ 2 $(0.118)$ 9 $(0.354)$ $\frac{\text{mm}}{\text{(in)}}$	Wire insulation stripping	Station: WSS Tool: WS140
	W14028G	Single-Hole Cartridges Solid Wire 28 AWG	 STRANDED 30 (19 x 42) AWG 30 (7 x 38) AWG SOLID 28 AWG $\phi 0.32$ $(\phi 0.013)$ 2 $(0.118)$ 9 $(0.354)$ $\frac{\text{mm}}{\text{(in)}}$	Wire insulation stripping	Station: WSS Tool: WS140



**W140 Blade Cartridge Range for WS140 High-Temperature Precision Wire Stripper Tweezers**

	Ref.	Description	Image and dimensions	Suggested components	Compatible with
	<b>W14030G</b>	Single-Hole Cartridges Solid Wire 30 AWG		Wire insulation stripping	Station: WSS Tool: WS140
	<b>W14032G</b>	Single-Hole Cartridges Solid Wire 32 AWG		Wire insulation stripping	Station: WSS Tool: WS140
	<b>W14034G</b>	Single-Hole Cartridges Solid Wire 34 AWG		Wire insulation stripping	Station: WSS Tool: WS140
	<b>W14036G</b>	Single-Hole Cartridges Solid Wire 36 AWG		Wire insulation stripping	Station: WSS Tool: WS140
	<b>W14037G</b>	Single-Hole Cartridges Solid Wire 37 AWG		Wire insulation stripping	Station: WSS Tool: WS140
	<b>W14038G</b>	Single-Hole Cartridges Solid Wire 38 AWG		Wire insulation stripping	Station: WSS Tool: WS140
	<b>W14040G</b>	Single-Hole Cartridges Solid Wire 40 AWG		Wire insulation stripping	Station: WSS Tool: WS140
		<b>W14003F</b>	Flat Cartridges 3 mm		Wire insulation stripping
<b>W14005F</b>		Flat Cartridges 5 mm		Wire insulation stripping	Station: WSS Tool: WS140

**W440 Blade Cartridge Range for WS440 High-Temperature Wire Stripper Tweezers**



	Ref.	Description	Image and dimensions	Suggested components	Compatible with
	<b>W440021</b>	Multi-Hole Cartridges Solid Wire 34 - 22 AWG		Wire insulation stripping	Station: WSB Tool: WS440
	<b>W440023</b>	Multi-Hole Cartridges Solid Wire 26 - 16 AWG		Wire insulation stripping	Station: WSB Tool: WS440
	<b>W440025</b>	Flat Cartridges 12.5 mm		Wire insulation stripping	Station: WSB Tool: WS440



