

JBC

www.jbctools.com

Product
website



INSTRUCTION MANUAL



FAE1

Fume Extractor for 1 Workbench

This manual corresponds to the following references:

FAE1-1C (120V)

FAE1-2C (230V)

FAE1-9C (100V)

Packing List

The following items are included:



Fume Extractor for 1 Workbench 1 unit

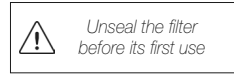

FAE1110
Pre-Filter
(M5, EN 779,
medium
efficiency)

FAE1100
Filter



Compact Filter
(active carbon filter
and particle filter
HEPA H13,
EN 1822)

FAE1100 Filter for FAE1 1 unit
Ref. FAE1-100 (already assembled inside the
Fume Extractor)



RJ12 Connection Cable 2 units
Ref. 0019751



Power Cable 1 unit
Ref. 0023715 (100V / 120V)
0023714 (230V)



USB Connection Cable
(USB-A to USB-B) 1 unit
Ref. 0021042



Station Connection Adapter
(RJ12 to USB-A) 1 unit
Ref. 0023504



Manual 1 unit
Ref. 0032497

*These station connection cables are only
required for compact station versions "E"
and previous versions.
Modular control units and compact stations
from version "F" require the RJ12 station
connection cable.*

Features and Connections

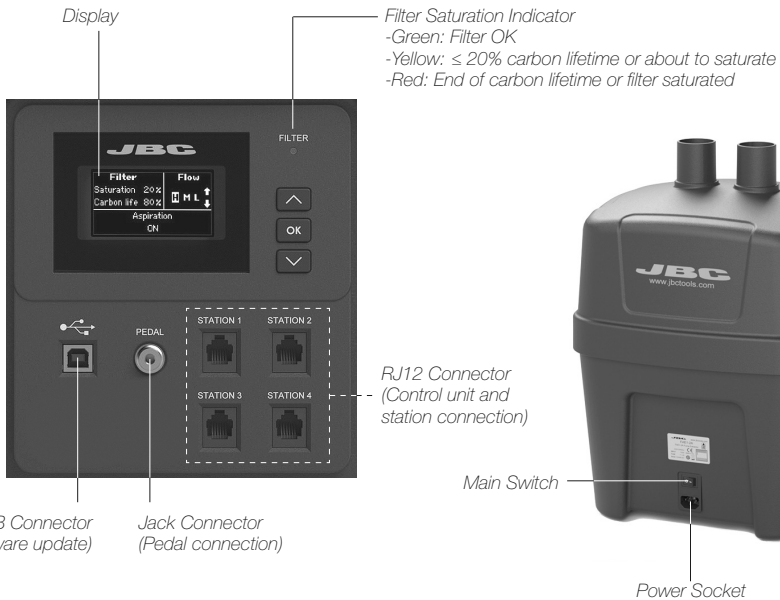

Standard Assembly

Configuration for 1 Workbench

F AE072
Flexible Arm with Clamp Ø50
 - Length: 1.2 m / 47 in
 - To be assembled onto the workbench with the included clamp.

F AE050
Fume Inlet Duct for Modular Stand (stands from versions Ref. xx-SD onwards)

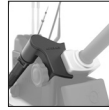

F AE060
Fume Inlet Duct for Compact Stations (stations from versions Ref.xx-xB onwards)



F AE022
Flexible Arm Ø50
 - Length: 1.2 m / 47 in
 - To be inserted and screwed directly onto the workbench (hole drilling required).

F AE040
Accessory for Stand Aspiration with Clamp
 - For flexible hose Ø50 mm.
 - To be fixed in place with the included clamp.
 - For up to 4 stands.

F AE030
Accessory for Stand Aspiration
 - For flexible hose Ø50 mm.
 - To be inserted and screwed directly onto the workbench (hole drilling required).

F AE010
Flexible Hose Ø50
 - Length: 1.5 m / 59.05 in
 - For connecting either to a flexible arm or to an accessory for the stand aspiration.
 - **Attention:** Avoid awkward positions in order to minimize pressure losses.

F AE1
Fume Extractor for 1 Workbench

Main Screen

Access by and to change the aspiration program.

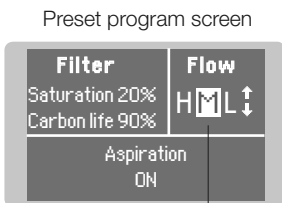

Aspiration Programs: high, medium and low.

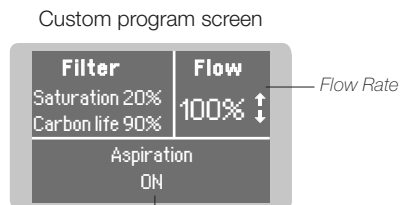

Aspiration Status

Alternative Assembly Option

Configuration for 2 Workbenches

This configuration is activated by setting Workbench option to “2” in the FAE1 main menu.



Main Screen

Access by and to change the aspiration program.

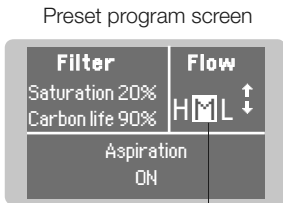

Aspiration Programs:
high, medium and low.

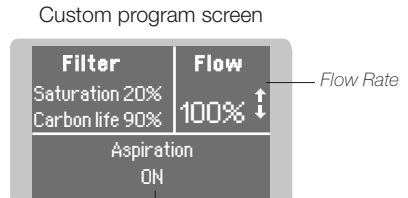

Flow Rate

Aspiration Status

Note: For this configuration stand aspiration is not available.

Compatibilities

This table shows the compatibility between the different ranges of nozzles and flexible arms for fume extraction that are available from JBC.

		FUME EXTRACTION ARMS			
		FAE020 <i>Compressed length: 0.9 m / 36.22 in</i>	FAE070 <i>Compressed length: 0.9 m / 36.22 in</i>	FAE022 <i>Compressed length: 1.2 m / 47 in</i>	FAE072 <i>Compressed length: 1.2 m / 47 in</i>
N O Z Z L E S	FAE080	OK	OK	X	X
	FAE081	OK	OK	X	X
	FAE082	OK	OK	X	X
	FAE083	OK	OK	X	X
	FAE090	X	X	OK	OK
	FAE091	X	X	OK	OK
	FAE092	X	X	OK	OK
	FAE093	X	X	OK	OK

Connection: FAE with NAE, DI and Modular Control Units

JBC control units can be connected to the fume extractor using an RJ12 cable (exception: to connect DI control units use the adapter and the USB-A/USB-B connection cable). This way, the fume extractor automatically starts extraction when the soldering tool is in use.

Update the control units with the latest software version (download from www.jbctools.com/software.html).

Minimum required software version to function with FAE:

Control units	Software version
DDE, HDE, NAE	8886160
DME	8886162
DI	8886602

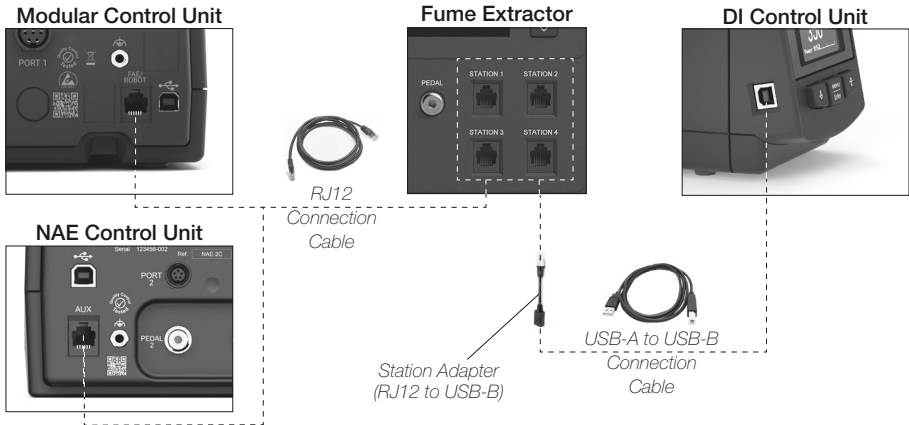

From software versions 8886887 (DDE,HDE) and 8886784 (NAE) on, the connected fume extractor can be configured and controlled through the Peripherals (1) menu of the control units. DI does not support this function.

Each control unit detects the fume extractor as "FAE_a" (2). The tool that should activate the fume extraction needs to be configured on the control unit main menu through the tool menu option (3).

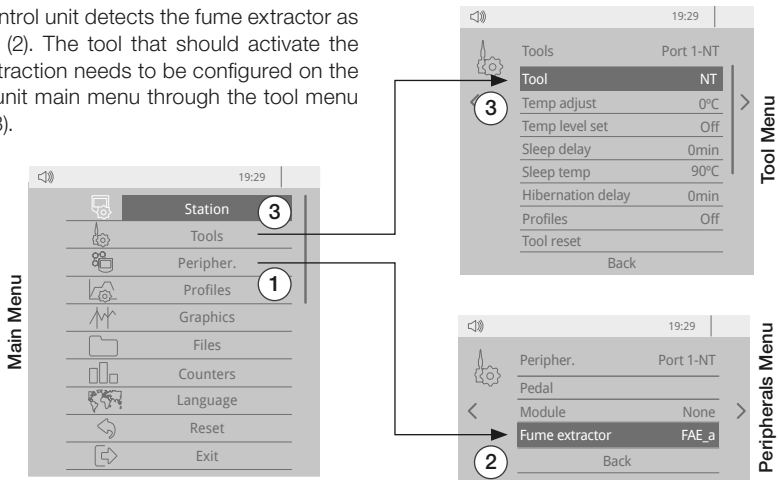

Connect up to 4 control units (connector FAE/ROBOT) to the fume extractor connectors (STATION 1, STATION 2, ...). Each tool connected to these control units can start and stop the fume extractor.

Connection: FAE with Compact Stations

Use the USB connection cable and the adapter or the RJ12 cable to connect JBC Soldering Stations. Both connections allow activating the extraction automatically when the tools are in use.

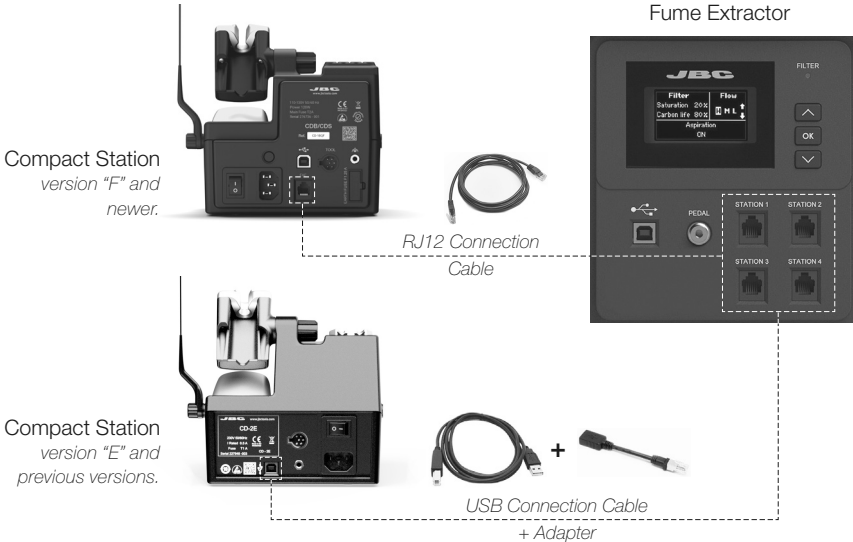

Important:  First connect the compact station to the fume extractor and then switch on the fume extractor. Otherwise the compact station will not be able to control the fume extractor.

Fume Extractor Firmware Update

FAE fume extractor can be updated via its USB-B connector by means of the USB connection cable. The firmware update file can be downloaded from www.jbctools.com/software.html.

Note: The RJ12 station connection cable must be disconnected for the update process. If a station is connected to the RJ12 connector, the update process will not start.

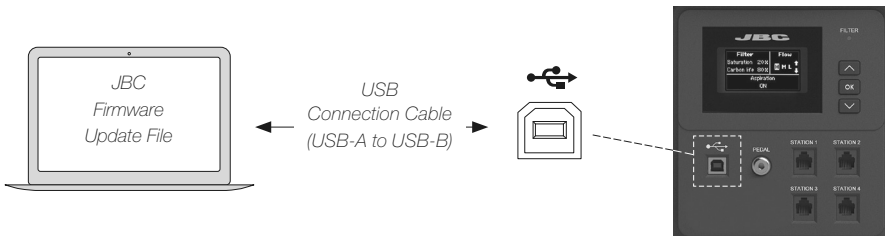

Menu Interface

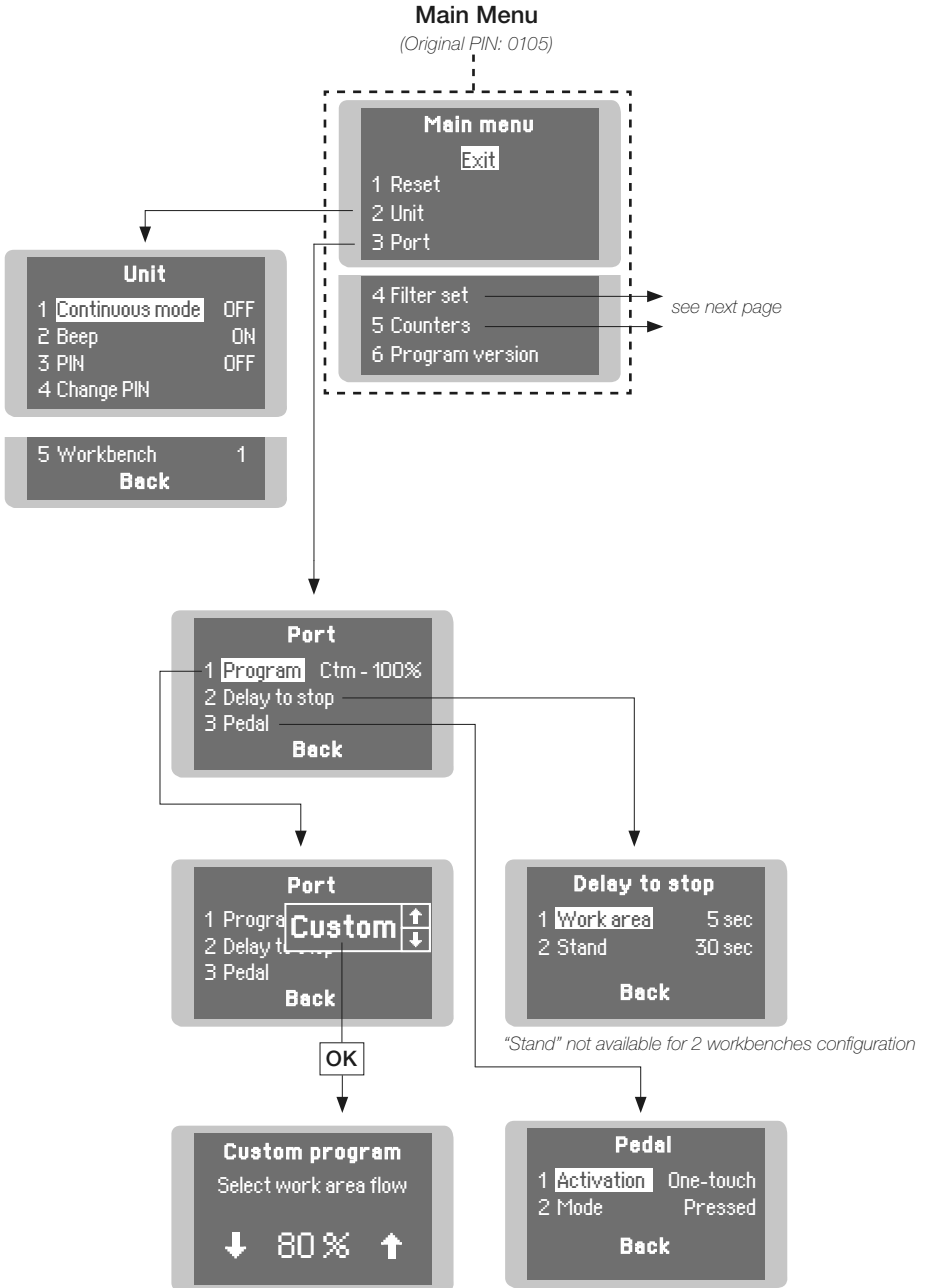

Menu Interface

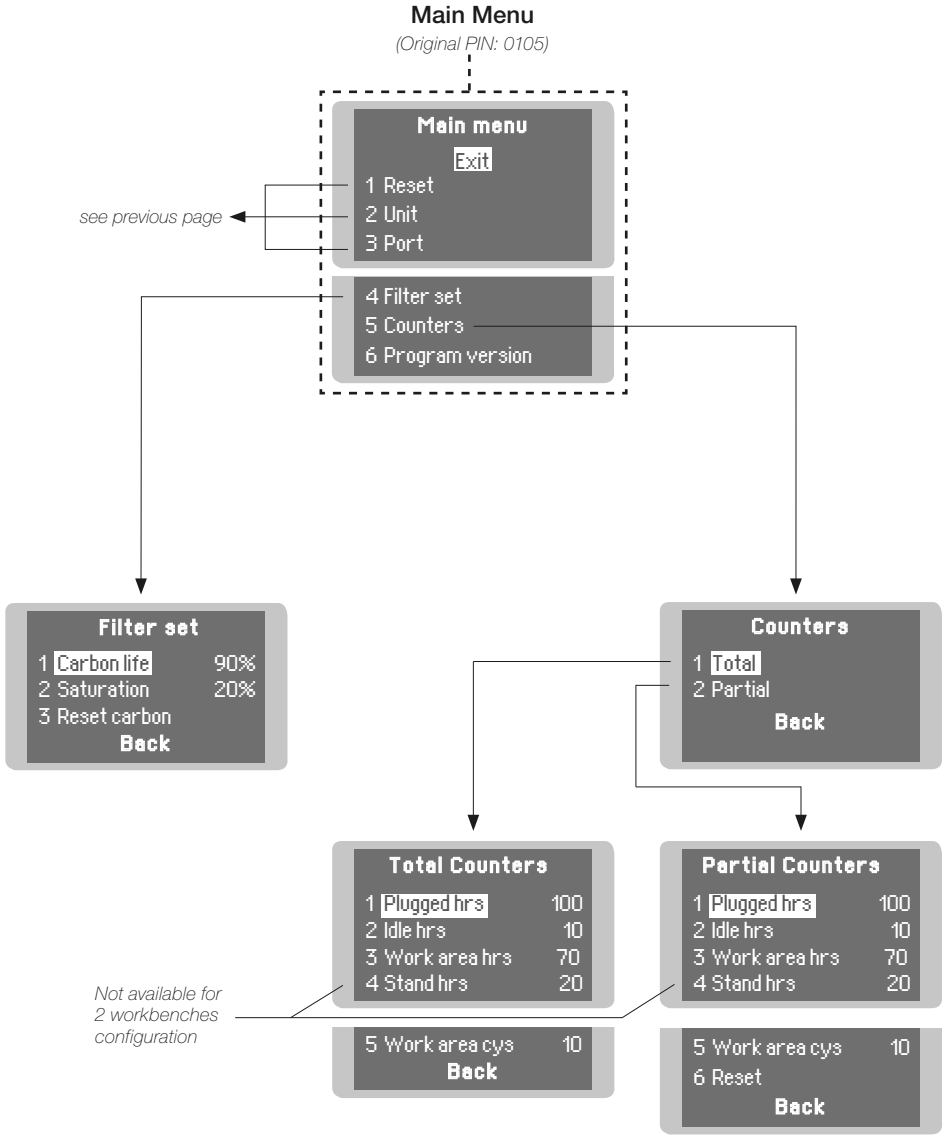

Fume Extractor Activation

Once the fume extractor is turned on, the display shows a similar screen as the following one and the filter saturation indicator is green if the carbon filter lifetime is higher than 20%.

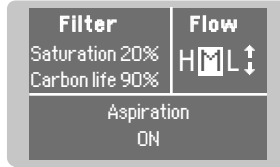

- **Green:** Filter OK
- **Yellow:** ≤ 20% carbon lifetime or about to saturate
- **Red:** End of carbon lifetime or filter saturated

If the display shows STOP#4, power off the fume extractor, remove the cover, place it back and secure it by using the quick release levers.



Troubleshooting

Station troubleshooting available on the product page at www.jbctools.com

Parameters



Important: Power off soldering stations connected to the fume extractor before modifying any parameter.

Unit

Parameter	Description
Continuous mode	Enable/disable continuous aspiration. Fume extractor aspirations remains active independently from tool or pedal status.
Ton	Enable/disable the sound of the keypad
PIN	Enable/disable PIN request when modifying parameters.
Change PIN	Change the default security PIN code. Default PIN 0105
Workbench	Select working mode for 1 or 2 workbenches (see page "Menu Interface").

Port

Parameter	Description
Program	<p>It sets the fume extractor aspiration flow. You can select between preset and custom aspiration programs.</p> <p>H (High), M (Medium) or L (Low) are the three available preset options. Use UP and DOWN keys to switch between them while being on the main screen.</p> <p>Up to ten aspiration levels between H (High) and L (Low) can be selected for custom program (range 10-100%). If a custom aspiration program is selected, the selected aspiration level can be changed on the main screen.</p> <p>By default, M (Medium) aspiration program is selected.</p>
Delay to stop / Stand	<p>It sets the time that a fume extractor keeps aspirating fumes at the stand once the tool is returned to it (range 0-999 seconds)</p> <p>By default stand time is 60 seconds.</p>
Delay to stop / Work area	<p>It sets the time that a fume extractor keeps aspirating fumes at the work area once the tool is returned to the stand (range 0-300 seconds).</p>
Pedal / Activation	<p>It sets the pedal activation mode. There are two different modes: “pressed” and “released”.</p> <p>Pressed: Aspiration is active as long as the pedal is pressed.</p> <p>Released (one-touch): Press the pedal once to activate the aspiration. To stop the aspiration, press the pedal again. A short tap on the pedal is enough.</p> <p>By default, activation is “pressed”.</p>
Pedal / Mode	<p>When the activation parameter is set to pressed, the mode parameter can be configured to released mode. In this mode aspiration is always active until the pedal is pressed.</p> <p>By default mode is pressed.</p>

Filter Set

Parameter	Description
Carbon life	It shows remaining activated carbon lifetime expressed in %. It is also displayed on the main screen. When 0% is reached the system will show pop-up message STOP#1 to replace the filter.
Saturation	It shows saturation status of HEPA + carbon filter set, expressed in %. It is also displayed on the main screen. When 100% is reached the system will show pop-up message STOP#2 to replace the filter.
Reset carbon	Perform this action after replacing the HEPA + carbon filter set. The carbon lifetime counter will not start until the filter is detected for the first time. After executing that function carbon filter life will be 100%.

Extraction Control via the Pedal

The fume extractor aspiration can be activated/deactivated by using JBC's pedal P405 or P005.

Pedal Connection

Connect the pedal to the pedal connector and read the description for "Pedal / Activation" and "Pedal / Mode" on the previous page.

P405 Pedal
or
P005 Pedal



Fume Extractor Configurations

Some parameters, features and the performance vary depending on fume extractor configuration, see the following table:

230V - 50/60Hz	Mode: 1 Workbench	Mode: 2 Workbenches
Flexible Arm Aspiration Intake	1	2
Stand Aspiration Intake	1	Not available
Flow per Flexible Arm Intake	80 m3 / h (47.08 cfm)	80 m3/h (47.08 cfm)
Preset Aspiration Programs	3	3
Custom Aspiration Programs	10	10
Power Consumption	130 W	300 W

120V - 50/60Hz	Mode: 1 Workbench	Mode: 2 Workbenches
Flexible Arm Aspiration Intake	1	2
Stand Aspiration Intake	1	Not available
Flow per Flexible Arm Intake	80 m3 / h (47.08 cfm)	75 m3/h (44.14 cfm)
Preset Aspiration Programs	3	3
Custom Aspiration Programs	10	10
Power Consumption	135 W	270 W

100V - 50/60Hz	Mode: 1 Workbench	Mode: 2 Workbenches
Flexible Arm Aspiration Intake	1	2
Stand Aspiration Intake	1	Not available
Flow per Flexible Arm Intake	80 m3/h (47.08 cfm)	65 m3/h (38.28 cfm)
Preset Aspiration Programs	3	3
Custom Aspiration Programs	10	10
Power Consumption	135 W	200 W

Maintenance - Filter Replacement

- The fume extractor unit indicates by means of the display and the indicator LED (3) that the filters need to be replaced.
- To replace the filters remove the cover (1) by opening the quick release levers (2), located on both sides of the casing.
- If the indicator LED (3) remains in red after replacing the pre-filter (4), it means that the main filter (5) is saturated and must also be replaced (see figure below) (6).
- After replacing the main filter (5), the carbon filter counter must be reset (Main Menu: *Filter Set > Reset Carbon*).
- The service life of the main filter is a maximum of 1 year after opening its packaging.
- If the main filter is changed while the fume extractor is switched on, the fume extractor unit automatically starts the filter detection process and activates the aspiration for a few seconds.

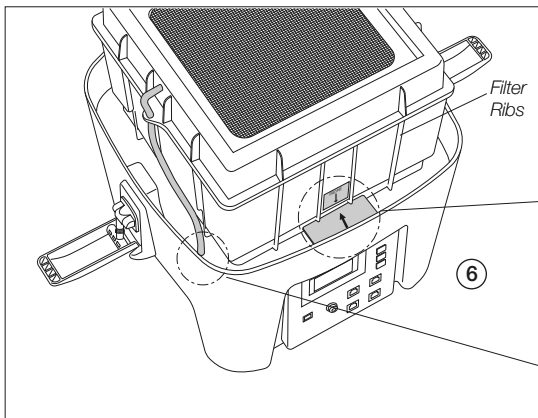
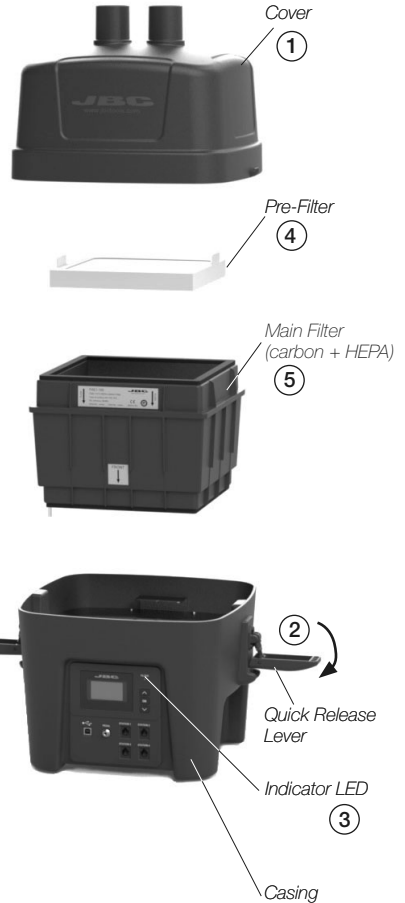

Note: The main filter has a given position. Make sure the filter ribs mate with the corresponding slots of the casing.

Connect the filter tube to the quick-coupling located on the fume extractor casing.

Quick Release Lever Adjustment

- To ensure that the filters are airtight, the locking force between the casing and the cover can be adjusted by turning the knurled nut of the locking lever.
- Turn the knurled nut clockwise to loosen and counterclockwise to tighten the locking force.

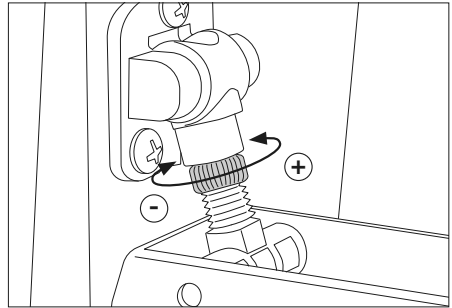

Filter Spare Parts

The following filters are available as spare parts for the FAE1:

FAE1100 Filter
with HEPA H13 for FAE1
Ref. FAE1-100

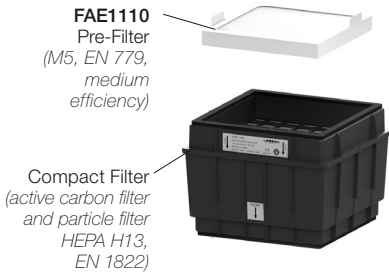

FAE1200 Filter
with HEPA H14 for FAE1
Ref. FAE1-200

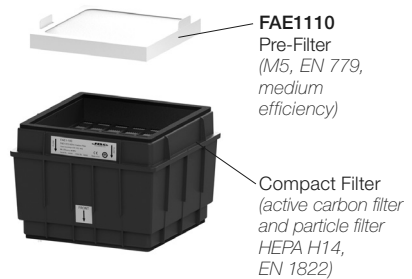

FAE1110
Pre-Filter for FAE1
Ref. FAE1-110
(M5, EN 779,
medium efficiency)



Read the safety guidelines thoroughly to perform the equipment maintenance safely.

Safety



Follow safety guidelines to prevent electric shock, injury, fire or explosion.

- The equipment is designed to filtrate only the fumes generated by soldering.
- Do not use the units for the filtration of combustible, explosive or corrosive gases. Incorrect use may cause fire.
- The power plug must be plugged into approved bases. Be sure that it is properly grounded before use. When unplugging it, hold the plug, not the wire.
- Do not leave the appliance unattended when it is on.
- Do not cover the ventilation grills. Heat can cause flammable products to ignite.
- This appliance can be used by children over the age of eight and persons with reduced capabilities or lack of experience provided that they have been given adequate supervision or instruction concerning use of the appliance and understand the hazards involved.
- Maintenance must not be carried out by children unless supervised.
- Keep your workplace clean and tidy. Wear appropriate protective mask, safety goggles and gloves when handling polluted filters or pre-filters.
- Do not use the equipment without the filters.
- Saturated filters can not be cleaned and reused.
- Avoid blowing out the filter or the dirty parts of the equipment, if necessary it is recommendable to vacuum them.
- When handling the filter, avoid losing particles from the filter.
- Treat the saturated filters as waste depending on the filtered contaminant and the applicable standards in each country. This is the European Waste Catalogue classification:
 - 15 02: Absorbents, filter materials, wiping cloths and protective clothing.
 - 15 02 02: Absorbents, filter materials (including oil filters not otherwise specified), wiping cloths, protective clothing contaminated by dangerous substances.
 - 15 02 03: Absorbents, filter materials, wiping cloths and protective clothing other than those mentioned in 15 02 02.
- In case of not complying with the filter change recommendations, the maximum particle and gas concentrations established in each country could be exceeded.

Specifications

FAE1

Fume Extractor for 1 Workbench

Ref.: **FAE1-1C** 120V 50/60Hz. Input power: 270W.Fuse 4A

FAE1-2C 230V 50/60Hz. Input power: 300W. Fuse 2.5A

FAE1-9C 100V 50/60Hz. Input power: 200W.Fuse 4A

- Working Areas (Workbenches): 1 or 2
- Noise: 55 dB @ 1m *
**FAE1-2C with 1 Workbench configuration and Low aspiration program.*
- Blower Type: Brushless
- Flow Rate: 230 m³/h (135 CFM)
- Max. Vacuum for 230V: 6 kPa (0.87 psi)
- Max. Vacuum for 120V: 4.3 kPa (0.62 psi)
- Max. Vacuum for 100V: 3.2 kPa (0.46 psi)

- Filters:

	Class	Standard	Efficiency
Dust filter (<i>Pre-filter</i>)	M5	EN 779	40-60 % @ 0,4 µm
	ePB10	ISO 16890	60% ≤ 10 µm
Particle Filter (<i>Compact Filter</i>)	HEPA H13	EN 1822	99,95% @ MPPS*
Gas Filter (<i>Compact Filter</i>)	Activated carbon		

**MPPS (Most Penetrating Particle Size) usually between 0,1-0,3 µm*

- Connections: USB-B
Pedal connector
Station connectors RJ12 (4x)
- Total Net Weight: 10.87 kg / 23.96 lb
- Total Package Dimensions / Weight:
(L x W x H) 425 x 425 x 545 mm / 12.90 kg
16.73 x 16.73 x 21.46 in / 28.45 lb

Complies with CE standards.
ESD safe.

JBC

Warranty

JBC's 2 year warranty covers this equipment against all manufacturing defects, including the replacement of defective parts and labor.

Warranty does not cover product wear or misuse.

In order for the warranty to be valid, equipment must be returned, postage paid, to the dealer where it was purchased.

Get 1 extra year JBC warranty by registering here:
<https://www.jbctools.com/productregistration/>
within 30 days of purchase.

If you register, you will receive e-mail notifications about new software updates for your registered product.



This product should not be thrown in the garbage.

In accordance with the European directive 2012/19/EU, electronic equipment at the end of its life must be collected and returned to an authorized recycling facility.

CE EAC UK
CA

www.jbctools.com

0032497-100226